



# LIMPOPO

**PROVINCIAL GOVERNMENT**  
REPUBLIC OF SOUTH AFRICA

---

**DEPARTMENT OF PUBLIC WORKS, ROADS & INFRASTRUCTURE**

---

**LDPWRI-B/20115**

**BID DOCUMENT**

**FOR THE**

**CONSTRUCTION OF NEW OFFICES AT BAKONE  
BA MATLALA TRADITIONAL COUNCIL IN  
CAPRICORN DISTRICT**

**MINIMUM CIDB GRADING: 6GB**

**September 2021**

---

DEPARTMENT OF PUBLIC WORKS, ROADS & INFRASTRUCTURE  
Private Bag x9490, Polokwane 0700  
Tel: (015) 284-7000

BID NO: LDPWRI-B/20115

BID NO:

LDPWRI-B/20115

# *BID DOCUMENT*

FOR THE

**CONSTRUCTION OF NEW OFFICES AT BAKONE BA MATLALA TRADITIONAL  
COUNCIL**

IN

**CAPRICORN DISTRICT**

FOR

***DEPARTMENT OF PUBLIC WORKS, ROADS &  
INFRASTRUCTURE  
LIMPOPO PROVINCE***

SEPTEMBER 2021

# CONTENTS

PART A: SPECIAL NOTES TO BIDDERS .....	1
PART T1: TENDERING PROCEDURE .....	14
T1.1 TENDER NOTICE AND INVITATION TO TENDER.....	14
T1.2 TENDER DATA.....	15
A. BID EVALUATION STAGE 3 - FUNCTIONALITY.....	21
PART T2: RETURNABLE DOCUMENTS.....	29
T2.1: LIST OF RETURNABLE DOCUMENTS.....	30
T2.2: RETURNABLE SCHEDULE .....	32
SBD 1: INVITATION TO BID.....	33
CERTIFICATE OF AUTHORITY .....	33
A. CERTIFICATE FOR COMPANY .....	33
B. CERTIFICATE OF PARTNERSHIP.....	33
C. CERTIFICATE FOR JOINT VENTURE.....	34
D. CERTIFICATE FOR THE SOLE PROPRIETOR.....	34
E. CERTIFICATE FOR CLOSE CORPORATION .....	34
F. BROAD-BASED BLACK ECONOMIC EMPOWERMENT.....	41
SBD 4: DECLARATION OF INTEREST .....	44
SBD 6.1: REFERENCE POINTS CLAIM FORM IN TERMS OF THE PREFERENTIAL PROCUREMENT REGULATIONS 2017 .....	47
SBD 6.2: DECLARATION CERTIFICATE FOR LOCAL PRODUCTION AND CONTENT .....	54
LOCAL CONTENT DECLARATION .....	57
GUIDANCE DOCUMENT FOR THE CALCULATION OF LOCAL CONTENT .....	59
TREASURY DESIGNATED SECTOR.....	62
ANNEX B: LOCAL CONTENT DECLARATION .....	75
ANNEX C: LOCAL CONTENT DECLARATION – SUMMARY SCHEDULE .....	77
ANNEX D: IMPORTED CONTENT DECLARATION – SUPPORTING SCHEDULE TO ANNEX C .....	82
ANNEX E: LOCAL CONTENT DECLARATION – SUPPORTING SCHEDULE TO ANNEX C.....	84
SBD 8: DECLARATION OF BIDDER’S PAST SUPPLY CHAIN MANAGEMENT PRACTICES.....	89

SBD 9: CERTIFICATE OF INDEPENDENT BID DETERMINATION .....	91
SAFCEC JOINT VENTURE AGREEMENT .....	98
THE CONTRACT.....	110
PART C1: AGREEMENT AND CONTRACT DATA.....	111
C1.1. FORM OF OFFER AND ACCEPTANCE .....	112
C2    CONTRACT DATA .....	115
PART C3: PRICING DATA .....	116
<b>C3.1 PRICING INSTRUCTION</b> .....	117
PART C4: PROVISIONAL BILLS OF QUANTITIES .....	118
PART C5: SCOPE OF WORKS .....	433
C5.1 SCOPE OF WORKS.....	434
PART C6: EPWP INFRASTRUCTURE GUIDELINE 2015 .....	435
PART C7: SITE INFORMATION AND DRAWINGS .....	532
PART C7.1: SITE INFORMATION.....	533
PART C7.2: DRAWINGS.....	534

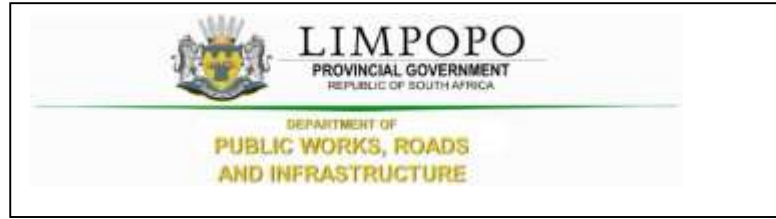

## **PART A: SPECIAL NOTES TO BIDDERS**



**LIMPOPO**  
PROVINCIAL GOVERNMENT  
REPUBLIC OF SOUTH AFRICA

DEPARTMENT OF  
**PUBLIC WORKS, ROADS  
AND INFRASTRUCTURE**

**NOTES TO BIDERS**

**NAME OF PARTIES**

**EMPLOYER**

Limpopo Province Department of Roads & Infrastructure: Works Towers  
43 Church Street  
Tel: (015) 284 7000/1  
Private BAG X9490  
POLOKWANE  
0700

**Contact:**

Maluleke ZV @ (015) 284 7219

**PROFESSIONAL TEAM (ARCHITECT, QUANTITY SURVEYOR AND ENGINEERING)**

Limpopo Province Department of Public Works, Roads and Infrastructure,  
Polokwane

**Contact:** (015) 284 7001

## **1. SPECIAL CONTRACT DOCUMENTS**

### **Note:**

The clauses in these Special Contract Conditions form part of the contract requirements and shall have preference over any contradicting clauses in these Bills of Quantities, the preliminaries, and the Conditions of Contract.

### **1.1 CONTRACT DOCUMENTS**

The Contract Document will consist of:

- I. The agreement shall be the JBCC Series 2000 Principal Building Agreement, prepared by the Joint Building Contracts Committee, Edition 4.1, and March 2005 amended as hereinafter described.
- II. Documents to be provided by the Contractor in terms of the requirements of these Provisional Bills of Quantities. Where reference is made to the "subcontract agreement" this is deemed to mean the "JBCC Series 2000 Nominated /Selected Sub-Contract Agreement" (March 2005 Edition)
- III. The JBCC Series 2000 Preliminaries prepared by the Joint Building Contracts Committee (May 2005 edition) amended as hereinafter described, shall be deemed to be incorporated herein.
- IV. Tenderers are referred to the above -mentioned documents for the full intent and meaning of each clause thereof. These clauses are hereinafter referred to by clause numbers and headings only, for which, such allowance must be made as may be considered necessary.
- V. Where standard clauses or alternatives are not entirely applicable to this contract such modifications, corrections or supplements as will apply are given as far as possible under each relevant clause. Where modifications or amendments as described are made, such modifications and/or amendments shall supersede any conflicting provision in the relevant clauses of the JBCC Series 2000 Preliminaries or the JBCC Series 2000 Principal Building Agreement and the tenderer shall make due allowance for whatever costs and charges he may consider necessary for the carrying out and observance of the provisions of the clauses as modified and/or amended.
- VI. Where any clause is not relevant to this specific contract such clause is marked N/A (signifying "not applicable").
- VII. "The Model Preambles for Trades" as recommended and published by the Association of South Africa Quantity Surveyors -1999 edition, shall be deemed to form part of this contract documentation. Any amendments and/or additional information is listed under the supplementary preambles at the start of each trade in the bills of quantities.
- VIII. **Pricing of preliminaries - The relevant clause numbers of sections A and B of the preliminaries are listed at the end of the contract preliminaries section for pricing purposes.** if Alternative as set out in clause 10 of the preliminaries hereinafter is to be used for the adjustment of the preliminaries, each item priced is to be allocated to one or more of the three categories.

- IX. The **tenderer** shall allow opposite each of the items for whatever costs and charges he may consider necessary for the carrying out, complying with and due observance of the provisions, conditions, and requirements set out therein.
- X. Only priced items will be considered in respect of any adjustments to this section. Any items left unpriced will be understood to be provided for in the rates given for other items and no claim for extras arising out of the tenderer's omission to price any item will be entertained.
- XI. Notwithstanding the period stated in the JBCC form of tenders, tenderers shall hold good for a period of one hundred and eighty (180) calendars days from the date of closing of the tenderers and shall not be altered, amended, or withdrawn during that period.



## **2.2 QUERIES FROM BIDDERS**

The pages of these bills of quantities are numbered consecutively as indexed on the first page.

The Bidder shall check the numbers of the pages and should any be missing or duplicated, or the reproduction be indistinct, or if any doubt exists as to the full intent or meaning of any description or these bills of quantities contain any obvious errors, the Bidder shall notify the Accounting Officer/ Quantity surveyor at once who shall promptly give a written directive. No liability whatsoever will be admitted in respect of errors in any BID due to the abovementioned causes.

On no account should these documents be used for placing orders for materials. Bidders do so at their own risk and shall not be reimbursed for additional costs so incurred.

## **2.3 ACQUAINTANCE WITH BID DOCUMENTS**

By submission of a BID, the Bidder will be deemed to have acquainted himself/herself fully with the BID documents, local authority requirements and by-laws and all aspects of the work envisaged in the documents before pricing and submission of his/ her BID. The employer may appoint a principal Agent to act on his/ her behalf with full authority and obligations.

## **2.4 FORMS TO BE COMPLETED**

The form of BID together with its appendices must be submitted with the BID.

## **2.5 SCOPE OF THE WORKS**

The project comprises the **CONSTRUCTION OF NEW OFFICES AT BAKONE BA MATLALA TRADITIONAL COUNCIL IN CAPRICORN DISTRICT** as well as related services in accordance with the drawings and specifications that will be provided to the contractor.

The Contractor shall provide sufficient qualified technical staff, field staff, and safety personnel to ensure the Works under this contract be satisfactorily carried out safely and meeting the performance targets and programs. The Contractor shall also provide competent attendant(s) to monitor any works concerning the scope of works.

## **2.6 PROGRAMMING WITH DIRECT CONTRACTORS**

Tenderers must take note that some work may be performed by independent/ direct contractors that will not form part of this contract. Tenderers, however, must make provision for these installations in their program and must provide all the necessary assistance to The **Limpopo Department of Public Works, Roads and Infrastructure in completion of the said contracts.**

- Any installations by specialists e.g., Security installation, loose furniture

## **2.7 SITE**

The site is at BAKONE BA MATLALA Traditional Council, in CAPRICORN DISTRICT

## **2.8 CONTRACT DOCUMENTS**

The contract/agreement will be based on the JBCC Series 2000 Principal Building Agreement, prepared by the Joint Building Contracts Committee, Edition 4.1, and March 2005.

Wherever reference is made to the terms "Client, Employer or Principal Agent) in the documents, it shall be deemed to mean. The Limpopo Department of Public Works, Roads, and Infrastructure or any person acting in such capacity as well as any officer to whom any power vested in terms of these conditions of the contract have been delegated to.

## **2.9 CONFIDENTIALITY OF BID DOCUMENTS**

All the recipients of BID documents shall be whether they submit a bid or not, treat the details of these documents as confidential and their general content shall not be disclosed or discussed with third parties without the prior approval of the **Limpopo Department of Public Works, Roads, and Infrastructure**.

## **2.10 BID ALL INCLUSIVE**

The Bidder must allow in his/ her BID for all labour, material, transport, handling, construction plant, temporary works, or method of construction where the method of payment allows for various methods of construction, value-added tax and everything else necessary for the execution and completion of the works in accordance with the BID documents

## **2.11 BILLS OF QUANTITIES**

**This Bill of Quantities is provisional and subject to be re-measured.**

The Contractor / Bidder is warned that if he/ she use any quantities or specifications appearing in these Bills of Quantities for ordering materials, he/ she does so at his/ her own and no liability whatsoever shall be admitted afterward by the **Employer / Limpopo Department of Public Works, Roads, and Infrastructure** for such correctness of such quantities or specifications.

## **2.12 STAMP DUTY**

If applicable, all stamp duties in connection with the contract shall be paid by the Bidder.

## **2.13 SIGNING OF BIDDERS**

The BID must be signed by a representative of the Bidder being duly authorized to do so and Bidders are to attach a company resolution.

#### **2.14 LODGING AND SCRUTINY OF PRICED BILLS OF QUANTITIES**

The Bidder's / Contactor's attention is specifically directed to the provision that, before the contract is signed, he/ she is to submit his/ her priced Bills of Quantities with conditions of contract and cast neatly in black ink for checking. The Accounting Officer / Quantity Surveyor will duly check the priced Bills of Quantities and shall make such adjustment of individual prices and rectify discrepancies as he may consider necessary. No artificial prices shall be acceptable.

#### **2.15 ADDITIONAL INFORMATION REQUIRED**

The **Employer / Limpopo Department of Public Works, Roads and Infrastructure** may ask any Bidder for a clarification/s of his / her BID. Nevertheless, no Bidder will be permitted to alter his / her BID sum after the BIDs have been opened and read to other bidders, although clarification which does not change the BID may be accepted.

The Employer reserves the right to appoint a firm of public accountants to report on the financial capacity of any Bidder. The Bidder shall provide all reasonable help and information in such an investigation.

All written information submitted by the Bidder together with and in support of his / her BID shall be considered to form the basis on which the BID has been prepared and submitted.

#### **2.16 ARITHMETICAL ERRORS**

The Accounting Officer / Quantity Surveyor reserves the right to correct arithmetical or other errors in the Officer / Surveyor for reasons which the Accounting Officer / Quantity Surveyor will indicate, the Bidder will, in terms of Rule 14, be requested to make corrections.

#### **2.17 IMBALANCE IN BIDDED/TENDERED RATES**

In the event of there being any rate or rates which are declared to be unacceptable by the Accounting officer/Quantity Surveyor for reasons which the Accounting Officer / Quantity Surveyor will indicate, the Bidder will, in terms of Rule 14, be requested to:

- a) Either justify and specify rate or rates, i.e. to give a financial breakdown on how such rate or rates were obtained or calculated, or
- b) Consider amending and adjusting such rate while retaining the BID sum derived under Sub-rule 15.a unchanged and fixed.

If the Accounting Officer / Quantity Surveyor requests the Bidder to adjust any unacceptable rate or rates, the Accounting Officer / Quantity Surveyor may at his / her discretion limit any such adjustment to rates in specific sections of the bills of quantities. On no account will the Accounting Officer / Quantity Surveyor permit the Bidder to use such an opportunity to re-price extensive sections of the bills of quantities, even though the BID sum remains unchanged.

### **2.18 ALTERATIONS TO BID DOCUMENTS**

No unauthorized alteration or addition shall be made to the form of BID, to the bills of quantities or any other portion of the BID documents. If any such alteration or additions is made and if the bills of quantities of not properly completed, the BID may be rejected, and the Employer will not be bound to by such alterations.

### **2.19 BID QUALIFICATIONS**

BIDs must be submitted strictly in accordance with the BID documents, i.e. without qualifications. Qualifications like statements of interpretation of contract documents must be avoided and any point of doubt or difficulty should be cleared with the Accounting Officer / Quantity Surveyor as early as possible during the BID period. Should any query be found to be any influence to the BID, all other Bidders shall immediately be informed of the particulars by the Accounting Officer / Quantity Surveyor.

### **2.20 COSTS INCURRED BY BIDDER**

The Employer shall not be responsible to pay for the expenses or losses, which may be incurred by any Bidder in the preparation of the BID or in visiting the site in connection herewith.

### **20.21 BID ACCEPTANCE**

The Employer will not be bound to accept the lowest or any BID. No reason for the acceptance or rejection of any BID will be given.

### **20.22 WITHDRAWAL OF BID AFTER CLOSING DATE**

The Bidder may not withdraw his BID after the time set for opening BIDs without any BID having been accepted.

Should a Bidder amend or withdraw his/her BID after the specified date and hour, but prior to his being notified of the acceptance thereof, or should a Bidder after having been notified that his/her BID has been accepted.

- (a) Give notice of his/her inability to execute the contract in terms of his BID; or
- (b) Fail to sign a contract or furnish the security within the period fixed in the BID Conditions reflected on the form of BID or any extended period fixed by the Employer; or
- (c) Fail to execute the contract;

He shall pay all additional expended, damages and/or losses which the Employer may incur in calling for fresh BIDs or by paying the difference between his/her BID and a less favorable BID accepted in terms of the provisions of the last paragraph of this term: Provided that the Employer may at its discretion exempt a Bidder from the provisions of this sub-rule if he believes that the circumstances justify the exemption.

When in circumstances mentioned in the second paragraph of this item, the Employer deems it not desirable to invite fresh BID; then the Employer may accept another BID from those already received. The provisions of **Rule 2.21 above, shall again apply.**

### **2.23 METHOD OF MEASUREMENT**

The Bills of Quantities have been measured in accordance with the 6<sup>th</sup> Edition of the standard system of Measuring Builders Work.

### **2.24 AVAILABILITY AND SUBSTITUTION OF MATERIALS**

Bidders are urged to make themselves, during BID stage, thoroughly acquainted with the availability of all materials for this project as no claim for non-availability or late delivery of materials will afterward be recognized/considered.

If materials specified are not available or it seems that there will be a delay of materials, then the Bidder must notify the **Employer** at once in writing who will, at his/her discretion, attend to the matter. Once the BIDs are handed in it will be taken that all materials specified in these Bills of Quantities are available and will be delivered on-site for completion of the project within the prescribed contract period.

The Substitution will be strictly subject to the **Employer's** approval.

The **Contractor** must, as far as possible, purchase materials available in the Limpopo Province provided the quality is acceptable. Materials of inferior quality shall under no circumstances be accepted. If the **Contractor** cannot comply with these conditions, he/she must substantiate this in writing with documentary proof from suppliers.

### **2.25 PROPRIETARY TYPES AND TRADE NAMES**

Where reference is made in these Bills of Quantities to proprietary types or names, the products, or materials, etc. referred to are to be exactly as described, the prior approval of the **Employer** must be obtained for any substitution and may be the subject to a variation order.

### **2.26 SABS SPECIFICATIONS**

All references in these Bills of Quantities to Specifications of the Bureau of Standards shall be deemed to be a reference to the latest issues of such specifications, and any subsequent amendments thereto. All articles, materials or items described as to conform to the SABS Specification must bear the SABS mark where possible.

### **2.27 PERFORMANCE GUARANTEE**

Where the project is over R 2 000 000.00 the Bidder must submit with this BID proof (using a letter of intent or otherwise) from his/her guarantor that his/her guarantor will issue the guarantee if the BID is accepted.

### **2.28 BID**

While the Employer reserves the right to accept or not accept any BID, the intention is that a BID will be accepted. The successful Bidder will be appointed as the Main Contractor in terms of the JBCC Series 2000 Principal Building Agreement, prepared by the Joint Building Contracts Committee, Edition 4.1, and March

2005. Any condition submitted by the Bidders which is a variance with the provisions of the main contract will not be accepted and may render the BID liable to disqualification.

The BID shall be sealed in an envelope and endorsed as per BID form and be deposited in the BID box as per BID advert.

**On no account will BIDS received after the time and date for submission of BIDs be considered and Bidders are advised that postal delays will not constitute a claim for recognition of such BIDS.**

Telegraphs or telefaxed BIDS will **NOT** be considered under any circumstances.

### **2.29 INSPECTION OF SITE**

**A Compulsory site inspection will be as per tender advert.** Tenderers are, however, urged to thoroughly inspect the site, acquaint themselves with the nature and extent of the works, the site conditions about power and water supply, transport facilities, conditions of adjacent existing buildings and also access to the site, availability of working space, etc.; before submitting their BIDs **as no extra cost arising out of their failure to price for the above mentioned shall be considered.**

### **2.30 SITE OFFICE**

The Contractor shall erect, maintain, and takedown on completion of the work a building for site meetings with a concrete floor, suitable roof, suitable walls, door, and four windows, with tables and chairs (not benches), all suitable to accommodate 12 persons.

It is further a condition that all work or movement of vehicles in the vicinity of this office that creates noise or nuisance during site meetings must be suspended for the duration of the site meetings.

### **2.31 LOCAL LABOUR**

As soon as the site is handed to the Contractor, he/she will be expected to form a joint committee with the local community. This committee will ensure that all unskilled and available semi-skilled labor are employed from the community.

All labour shall apply through the committee for employment on the project and the selection of these labourers shall be made by the Contractor from a list of applicants compiled by the community members on the committee.

On all labour-intensive projects, at least 10% of the labourers must be employed from the local community where the project will be executed.

Labourers should be paid in accordance with the provision of the Labour Relations Act, Act 23 of 1956 and the amended Basic Conditions of Employment of 1983, or any latest available Acts.

In accordance with Government Gazette No.16095 of 19 November 1994 wages differ for different areas.

### **2.32 PROCEDURE OF THE WORK**

The Employer reserves the right to direct the order in which the various parts of the contract will be executed should circumstances warrant such action.

### **2.33 VARIATIONS**

Where prices are submitted by the Contractor or Nominated Sub-Contractor during the progress of the works in respect of variations or regarding a claim under the terms of the contract and even though such prices may be used in an interim certificate, it is hereby agreed that there is to be no presumption of acceptance. Should the Employer wish to accept any such prices before the issue of the final certificate, he will do so in writing.

### **2.34 PROVISIONAL WORK**

Any increase or decrease of work measured provisionally will not be sufficient grounds for any adjustments in the tendered rates.

### **2.35 MONEY/BUDGET OR PROVISIONS**

Whatever an amount for work is allowed in these Bills of Quantities under the term "Money/budgetary Provision" it shall be taken that such amount is for work to be carried out by Specialists, who will be ordinary domestic Sub-Contractors to the Main Contractor.

### **2.36 BORROW PITS**

It is the responsibility of the Contractor to find the necessary borrow pits for imported filling and also to ascertain the suitability and acceptability of such filling, as no claims in this regard will be entertained afterward.

### **2.37 TESTS**

It is the responsibility of the Contractor to carry out his/her tests during the execution of the contract to check the strength of concrete, mortar, the density of filling, etc., and only those tests as requested by the Employer will be paid for by the Client.

### **2.38 THE CONTRACT PERIOD**

The contract period shall be 12 months (exclusive of builder's holiday) from the date of site handover.

### **2.39 COMPLETION OF BID DOCUMENTS**

Bidders shall ensure that all documents requiring completion are duly completed in ink (black), signed, and witnessed in the spaces provided.

### **2.40 OCCUPATIONAL HEALTH AND SAFETY**

In terms of the Occupational Health and Safety Regulations promulgated on 18 July 2003, Bidders are advised that they are required to comply fully with such regulations about this project as no claims in this regard will be entertained.

#### **2.41 VALUE ADDED TAX**

Value-added tax must be added to the contract amount in the Final Summary and all amounts, rates, etc. in the Bills of Quantities will, therefore, be exclusive of value-added tax.

#### **2.42 PRICES ALL INCLUSIVE**

The Bidder must allow in his/her BID for all labour, material, transport, handling, construction plant, temporary works, or method of constructions where the method of payment allows for various methods of construction, value-added tax and everything else necessary for the execution and completion of the works in accordance with the BID documents.

#### **2.43 PROOF OF PAYMENT OF VALUE ADDED TAX OR ANY APPLICABLE IMPORT DUTY**

The Bidder is to provide proof that he/she and all his Sub-Contractors are registered at the Receiver of Revenue for VAT or any applicable import duty purposes and will submit all names of Sub-Contractors to the Employer. The Employer may submit all this information to the Receiver of Revenue.

#### **2.44 WORKMEN'S COMPENSATION**

The Contractor must provide valid proof of active registration with the workmen's compensation fund (COIDA).

#### **2.45 CONTRACT PRICE ADJUSTMENT**

The BID will be subject to Escalation and the base month will be based on the date of tender closing.

#### **2.46 GENERAL NOTES**

Should the tender be awarded to the successful tenderer, the following is to be noted:

- No works shall commence until the Health and Safety Plan has been issued by the successful tenderer and has been approved by the Department of Public Works, Roads and Infrastructure representative.
- No work shall commence on site until all CAR and PL insurances are in place
- No payment shall be made until all guarantees are in place.
- Workers employed by the Contractor will not be allowed to be seen lingering around existing facilities or disturbing classes.
- The Contractor must not render any construction activities that will affect the Client operation before informing the Employer for approval thereof.
- The Contractor's workers should be noticeable by wearing proper clothing with the company logo.

#### **2.47 PAYMENT PROCEDURE**

Payment procedure in terms of this contract shall be as follows:

- The Contractor to submit valuation by the 20<sup>th</sup> of the Month.
- The payment shall be issued to the Department of Sports, Arts and Culture by the 7<sup>th</sup> of the following month, with payment being made by the 30<sup>th</sup> of that month.
- Every effort will be made to achieve payments earlier, but this cannot be guaranteed.



- Interest on late payments shall be charged at the prime rate.
- Payment for unfixed materials (Material on site) on-site shall be allowed.
- Payment for materials off-site shall only be allowed subject to written approval by the Employer, which will only be conditional upon the necessary cessions being in place and any other documentation which the Employer requests.

#### **2.48 INFORMATION RELEVANT TO INSURANCES**

The Contractor will be expected to take the following insurance with a deductible to be determined by the Contractor. In addition to the above-mentioned, the Contractor should take any other insurances relevant to the proper execution of the works.

##### **2.49.1 CONTRACT WORKS**

– Estimated Contract Amount plus 20%

##### **2.49.2 PUBLIC LIABILITY**

– R 10 000 000.00

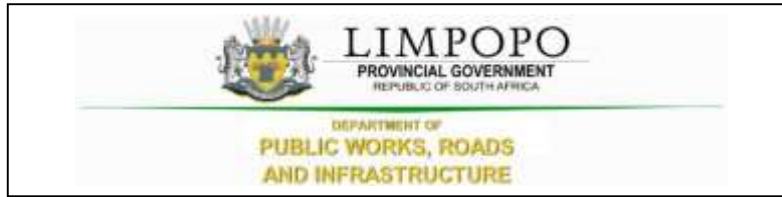

## PART T1: TENDERING PROCEDURE

### T1.1 TENDER NOTICE AND INVITATION TO TENDER

The Limpopo Department of Public Works, Roads and Infrastructure invites tenders for the **CONSTRUCTION OF NEW OFFICES AT BAKONE BA MATLALA TRADITIONAL COUNCIL IN CAPRICORN DISTRICT.**

It is estimated that tenderers should have a CIDB **class grading of 6GB or higher.**

Only tenderers who meet the minimum requirements stated in the tender data are eligible to submit tenders.

A non-refundable tender deposit of **as per Tender Advert** payable in cash is required on collection of the tender documents.

Tender documents are obtainable at Works Towers, Department of Public Works, Roads, and Infrastructure, 43 Church Street, Polokwane, during the following times: 08:00 to 15:00 (Monday to Friday) as from **as per Tender Advert.**

Queries relating to the issue of these documents may be addressed in writing to **Ms Moloto V**, **Tel. No.015 284 7142**; email: [molotomv@dpw.limpopo.gov.za](mailto:molotomv@dpw.limpopo.gov.za).

A compulsory briefing meeting with representatives of the Employer will not take place due to the Covid-19 Lockdown restrictions. However, tenderers are welcomed to make arrangements to visit the site on a non-compulsory basis at the **BAKONE BA MATLALA TRADITIONAL COUNCIL OFFICES IN CAPRICORN DISTRICT.**

The closing date and time for receipt of tenders are **as per Tender Advert.**

**Telegraphic, telephonic, scanned documents, facsimile, e-mail, and late tenders will not be accepted.**

Tenders must only be submitted on the tender documentation that is issued including priced bills of quantities.

Requirements for sealing, addressing, delivery, opening and assessment of tenders are stated in the Tenders Data.

**It remains the responsibility of the bidders that the bid document reaches the tender box by the stipulated closing date and time as advertised on the tender bulletin.**



## T1.2 TENDER DATA

The conditions of tender are the Standard Conditions of Tender as contained in Annex F of the CIDB Standard for Uniformity in Construction Procurement (July 2015) as published in Government Gazette No 38960, Board Notice 136 of 10 July 2015. (See [www.cidb.org.za](http://www.cidb.org.za)).

The Standard Conditions of Tender make several preferences to the Tender Data for details that apply specifically to this tender. The Tender Data shall have precedence in the interpretation of any ambiguity or inconsistency between it and the Standard Conditions of Tender.

Each item of data given below is cross-referenced to the clause in the Standard Conditions of Tender to which it mainly applies.

Clause number	Tender Data
F.1.1	The Employer is the Limpopo Department of Public Works, Roads and Infrastructure

<p>F.1.2</p>	<p>For this contract, the following documents will be adopted: The <b>single-volume</b> procurement document issued by the employer comprises of the following:</p> <p><b>Part A1: Special Notes to Bidders</b></p> <p><b>The Tender</b> <b>Part T1: Tendering procedures</b> T1.1 Tender notice and invitation to tender T1.2 Tender data</p> <p><b>Part T2: Returnable documents</b> T2.1 List of returnable documents T2.2 Returnable schedules</p> <p><b>The Contract Part C1: Agreements and contract data</b> C1.1 Form of offer and acceptance C1.2 Contract data</p> <p><b>The Contract Part C3: Pricing data</b> C3.1 Pricing instructions</p> <p><b>The Contract Part C4: Provisional Bills of Quantities</b> C4.1 Preliminaries C4.2 Building Works C4.3 Electrical Installation C4.4 Mechanical Installation C4.5 Civil Works C4.6 External Works C4.7 COVID-19 Health and Safety Compliance C4.8 Provisional Sums</p> <p><b>Part 5: Scope of work</b> C5.1 Scope of work</p> <p><b>Part 6: EPWP Infrastructure Guideline 2015</b> C6.1 Data Collection Tool</p> <p><b>Part 7: Site information and drawings</b> C7.1 Site information C7.2 Drawings</p>
<p>F.1.3</p>	<p>The employer's representative is:</p> <p>Name : V Maluleke Address : Department of Public Works, Roads and Infrastructure. Works Towers, 43 Church Street. Tel : 015 284 7219 Fax:</p>
<p>F.1.4</p>	<p>The language for communications is English</p>
<p>F.2.1</p>	<p>Only those Bidders who satisfy the following eligibility criteria are eligible to submit tenders:</p> <ol style="list-style-type: none"> <li>1. The Bidder is a Firm.</li> <li>2. Bidders that satisfy the criteria stated in the tender data and the tenderer or any of his principles is not under any restriction to do business with the employer.</li> </ol>

F.2.2	<p>Compulsory site briefing</p> <p>A compulsory site briefing meeting with representatives of the Employer will not take place due to the Covid-19 Lockdown restrictions. However, tenderers are welcomed to make arrangements to visit the site on a non-compulsory basis at the BAKONE BA MATLALA TRADITIONAL COUNCIL OFFICES IN CAPRICORN DISTRICT.</p>
F.2.3	<p>Tenderers may request clarification of the tender documents by notifying the employer at least five (5) working days before the closing time and date stated in the <b>Tender Advert</b>.</p>
F.2.4	<p>No alternative tender offers will be considered.</p>
F.2.5	<p>The list of Returnable Documents identifies which of the documents a tenderer must complete when submitting a tender offer. The tenderer must submit his tender offer by completing the Returnable Documents, signing the "Offer" section in the "Form of Offer and Acceptance" and delivering the Returnable Documents back to the Department.</p>
F.2.6	<p>Sign the original and all copies of the tender offer where required in terms of the tender data. The employer will hold all authorized signatories liable on behalf of the tenderer. Signatories for tenderers proposing to contract as consortiums shall state which of the signatories the lead is partner whom; the employer shall hold liable for the tender offer.</p>
F.2.7	<p>The employer's details and address for delivery of tender offers and identification details that are to be shown on each tender offer package are:</p>
F.2.8	<p><b>Location of the tender box: Department of Public Works, Roads and Infrastructure,</b></p> <p><b>Physical Address: Corner River and Blaauwberg streets, Ladanna, 0699.</b></p> <p><b>Identification details:</b> Tender reference number, Title of Tender and the closing date and time of the tender.</p>
F.2.9	<p>Telephonic, telegraphic, telex, facsimile or e-mailed tender offers will not be accepted.</p>
F.2.10	<p>Tenderers are alerted that tender offers which do not provide all the data or information requested completely and, in the form, required, may be regarded by the employer as non-responsive.</p>
F.2.11	<p>The closing time for submission of tender offers is as stated in the Tender Notice and Invitation to Tender.</p>
F.2.12	<p>The tender offer validity period is <b>180 Days</b>.</p>
F.2.13	<p>A valid Tax Clearance / Compliance Certificate, or a unique security Personal Identification Number (PIN) issued by the South African Revenue Services (where Consortium / Joint Venture / Sub-contractors / Sub-consultants are involved, each party to the association must submit a separate Valid Tax Clearance / Compliance Certificate or a unique security personal Identification number)</p>
F.3.1	<p>Tenders will not be opened immediately after the closing time for tenders.</p>
F.3.2	<p>The tenderers will be evaluated in <b>four</b> stages</p> <ul style="list-style-type: none"> <li>(i) Compliance documents – refer to the list of returnable documents (Part T2)</li> <li>(ii) Local Content (SBD 6.2) and its Annexures</li> <li>(iii) Functionality</li> <li>(iv) Price and Preference (BBBEE)</li> </ul>

<p>F.3.3</p>	<p><b>Scoring Financial Offer:</b></p> <p>Tender offers will be scored using the following formula: <math>NFO = \left(\frac{Pm}{P}\right) \times 100</math></p> <p>Where</p> <p>NFO = number of tender evaluation points awarded for the financial offer.</p> <p>W1 = the percentage score given for financial offer as stated in the Notice and Invitation to Tender T1.1</p> <p>Pm = the comparative offer of the most favourable tender offer. P = the comparative offer of the tender offer under consideration.</p> <p>where</p> <p>W1 = the number of tender evaluation points for the financial offer and equals:</p> <ol style="list-style-type: none"> <li>1) 90 where the financial value inclusive of VAT of all responsive tenders received has a value above R 50 000 000; or</li> <li>2) 80 where the financial value inclusive of VAT of one or more responsive tender offers equals or is less than R 50 000 000.</li> </ol> <p>Scoring Preferences:</p> <p>Up to 20 points will be awarded to the tenderer who completes the referencing schedule and who is found to be eligible for the preference claimed</p>
	<p><b><i>The Department is not obliged to award the tender to the bidder with the highest number of tender points.</i></b></p>

## TENDER EVALUATION CRITERIA AND WEIGHTINGS

### NOTES TO BIDDERS

#### 1.1 CRITERIA USED FOR THE EVALUATION/ ADJUCATION OF INFRASTRUCTURE RELATED BIDS

1.1.1 The points are allocated as follows:

1.1.2 For projects above R500 000, the distribution of points is used as follows:

##### A. BID EVALUATION STAGE 2- LOCAL CONTENT (SBD 6.2)

1.1 A bid may be disqualified if the Local Content Declaration Certificate and the Annexure C (Local Content Declaration: Summary Schedule) are not submitted as part of the bid documentation.

1.2 This tender is subject to Regulation 8 “Local Production and Content” of the Preferential Procurement Policy Framework Act, 2017: Preferential Procurement Regulations, 2017 submitting of SBD 6.2 and its declarations is compulsory. Please note a minimum threshold of for local content and production in relation to this bid (refer to the list of Designated Items for Local Production and Content)

1.2.1 Evaluation in terms of the stipulated minimum threshold for local production and content. LDPWRI-B/20015 will be evaluated in terms of minimum thresholds for local content stipulated in the LDPWRI-B/20015 document. The declaration made by the BIDDER in the Declaration Certificate for Local Content and Annex C (Local Content Declaration: Summary Schedule) will be used for this purpose.

1.2.2 All responses that will not meet the required minimum threshold “Annexure 1 (SBD 6.2” for local content as stipulated in the specifications will be disqualified and not evaluated further. Only Bidders that achieved the minimum threshold for local content and production will be evaluated further in terms of functionality and preference point system prescribed in the Preferential Procurement Regulations, 2017.

1.2.3 All Declarations for Local Content and Production must be fully completed and signed.

**N.B** Bidders will need to meet a minimum threshold percentage for local production and content as stipulated in the Bid Document (refer to the list of Designated Items for Local Production and Content) to be further evaluated in terms of the 80/20 preference point system prescribed in the Preferential Procurement Policy Framework Act, 5/2000 and preferential procurement regulations of 2017.

1.2.4 The exchange rate to be used for the calculation of Local Production and Content must be the exchange rate published by the South African Reserve Bank (SARB) during the advertisement period of this LDPWRI-B/20115.

1.2.5 Only the South African Bureau of Standards (SABS) approved technical specification number SATS 1286:2011 will be used to calculate local content.

2.6 The Local Content (LC) expressed, as a percentage of the bid price will be calculated in accordance with the following formula:

$$LC = (1 - x/y) * 100$$

Where

X is the imported content in Rand

Y is the quotation price in Rand excluding value added tax (VAT)

1. The exchange rate to be used for the calculation of local production and content must be the exchange rate published by the South African Reserve Bank (SARB) at 11:00 on Friday, 21 February 2020.

2. Only the South African Bureau of Standards (SANS) approved technical specification number SATS 1286:2011 must be used to calculate local content.



**A. BID EVALUATION STAGE 3 - FUNCTIONALITY**

**NOTE: Functionality -A bidder must obtain a minimum of 70% under functionality to qualify for final evaluation.**

Responsive bids will be evaluated using a point system which awards on the basis set out in the table below:

Functionality	Weighting
<p><b>Current Workload of Bidder</b></p> <ul style="list-style-type: none"> <li>• The current value is equal or greater than twice the maximum value of the required CIDB grade = 0</li> <li>• The current value is greater than the maximum value of the required CIDB grade but less than twice the maximum value of the required CIDB grade = 5</li> <li>• The current value is within the required CIDB threshold = 12</li> <li>• The current value is less than the minimum value of the required CIDB grade = 20</li> </ul> <p>Current value refers to the current value of projects for both General Building (GB) and Civil Engineering (CE). Please list the current projects which your company is busy executing in Table 1.</p> <p>NB: Completion of this table is mandatory for points to be allocated. Do not refer to any attachment. If no projects at the moment the tenderer must indicate on this table. Misrepresentation of facts will render your bid non-responsive.</p>	<p>20</p>

**Table 1 List of current projects executed by the bidder**

1. Do you have current projects being executed Yes/No?
2. If Yes, please indicate the details on the table below. Please note that it is compulsory to answer the question and if the answer is yes, complete the table. If the question is not answered or the table is not completed the points will not be allocated.

Project Description	Project Value	Start date	Planned end date	Client Name	Contact Person number

<p><b>Profile of key staff</b> (the key staff must be linked to project-specific organogram). CVs and certified copies of qualifications must be attached for points to be allocated. NB: List the details of key staff in Table 2. Completion of this table is mandatory for points to be allocated.</p>	<p><b>Weighting</b></p>
<p><b>Project Supervisor/Site Agent</b></p> <p>Qualification</p> <ul style="list-style-type: none"> <li>• Registration as a professional engineer, technologist, architect, construction manager or quantity surveyor = 5</li> <li>• Degree in built environment = 3</li> <li>• National Diploma in Built environment = 1</li> </ul> <p>Experience</p> <ul style="list-style-type: none"> <li>• 5 years' experience or more = 5</li> <li>• Between 2- and 5-years' experience = 3</li> <li>• Less than 2 years = 1</li> </ul> <p><b>Construction Manager</b></p> <p>Qualification</p> <ul style="list-style-type: none"> <li>• Registration as a professional engineer, technologist, architect, construction manager or quantity surveyor = 5</li> <li>• Degree in built environment = 3</li> <li>• National Diploma in Built environment = 1</li> </ul> <p>Experience</p> <ul style="list-style-type: none"> <li>• 5 years' experience or more = 5</li> <li>• Between 2- and 5-years' experience = 3</li> <li>• Less than 2 years = 1</li> </ul> <p><b>Site Safety Officer</b></p> <ul style="list-style-type: none"> <li>• Registration with the South African Council for Project and Construction Management Professions (SACPCMP) as a Construction Health and Safety Officer / Construction Health and Safety Manager = 5</li> <li>• No registration with the South African Council for Project and Construction Management Professions (SACPCMP) as a Construction Health and Safety Officer / Construction Health and Safety Manager = 0</li> </ul> <p>Experience</p> <ul style="list-style-type: none"> <li>• 5 years' experience or more = 5</li> <li>• Between 2- and 5-years' experience = 3</li> <li>• Less than 2 years = 1</li> </ul>	<p>30</p>

**Table 2 Details of key staff.**

<b>Name</b>	<b>Position</b>	<b>Qualifications</b>	<b>Professional Registration (if any)</b>	<b>Experience: Number of year (s)</b>	<b>Indicate whether full time or part-time on this project</b>

Experience in similar projects in the last 10 years	Weighting
<ul style="list-style-type: none"> <li>• Similar Projects = 5 to 20</li> <li>• If Project(s) value is greater than 1,5 times the maximum value of the required CIDB grade = 20</li> <li>• If Project(s) value is greater than the maximum value of the required CIDB grade but less than 1,5 times the maximum value of the required CIDB grade = 15</li> <li>• If Project(s) value is within the required CIDB threshold = 10</li> <li>• If Project(s) value is equal to or greater than the minimum value of the required CIDB grading and less than twice the minimum value of the required CIDB grade = 5</li> <li>• If Project(s ) value is less than the minimum value of the required CIDB grade = 0</li> <li>• If Projects value is for unrelated project (s) = 0</li> </ul> <p><b>NB: The details of completed projects must be entered in Table 3. Completion of this table is mandatory for points to be allocated. Appointment letters and completion certificates must be attached for points to be allocated.</b></p>	20

**Table 3 Details of projects completed in the last 10 years**

Project Description (include type of works- GB, CE, etc.)	Project Value	Completion Certificate attached (Yes/No)	Client Name	Contact Person (Tel)

Proposal and methodology	Weighting
<ul style="list-style-type: none"> <li>• <b>Project Proposal/Method Statement</b>  Project Proposal/Approach =10 <ul style="list-style-type: none"> <li>- Project Proposal / Method Statement covers all aspects of the project scope of work and construction procedures = 10</li> <li>- Project Proposal / Method Statement partly covers aspects of the project scope of work and construction procedures = 5</li> <li>- Project Proposal / Method Statement does not cover any aspects of the project scope of work and construction procedures = 0</li> </ul> </li>   <li>• <b>Project Schedule/programme</b> (acceptable scheduling software)  Programme Schedule/programme Gantt Chart =10 <ul style="list-style-type: none"> <li>- Programme must be in line with the scope of work and contract period and the activities sequencing must be logical.</li> </ul> </li>   <li>• <b>Cashflow projections</b>  The cash flow projections =10 <ul style="list-style-type: none"> <li>- The Cashflow must be in line with the construction program.</li> </ul> </li> </ul>	<p>30</p>



## **PART T2: RETURNABLE DOCUMENTS**



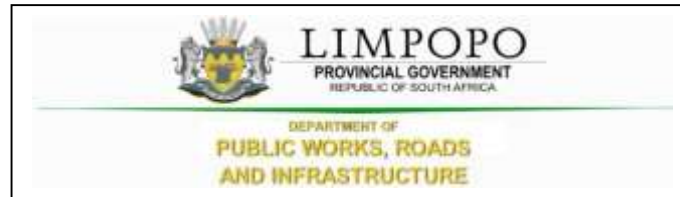

## T2.1: LIST OF RETURNABLE DOCUMENTS

### BID EVALUATION STAGE 1- MANDATORY REQUIREMENTS

1. The following returnable documents are compulsory, failure to comply will be considered non-responsive, and the bid will not be evaluated any further. All returnable documents are incorporated into the bid documents.
  - SBD1: Invitation to Bid (fully completed and signed)
  - Submit a power of attorney/Certificate of Authority (fully completed and signed)
  - Record of Addenda (where applicable)
  - SBD 4: Declaration of Interest
  - SBD 6.1: Reference Points claim form in terms of the Preferential Procurement Regulations 2017 or amended.
  - SBD 6.2 Declaration Certificate for Local Production and Content
  - SBD 8: Declaration of the bidder's past SCM practices
  - SBD 9: Certificate of Bid determination
  - C1.1: Form of the offer (PART C1)
  - Joint venture certificate (where applicable)
  - Bidding entity must not have any of their directors/shareholders listed on the Register of Tender Defaulters in terms of the Prevention and Combating of Corrupt Activities Act of 2004 as a person prohibited from doing business with the public sector;
  - Bidding entity must not appear on the National Treasury's list of blacklisted entities
  - Completion of the Bid Document must be done with a non-erasable black pen
  - Submission of fully completed original tender document
  
2. The following returnable documents are **required for tender evaluation purposes**.
  - Curriculum Vitae (not longer than 4 pages) of all key staff allocated to this project, indicating their experience and qualifications and professional registration with various councils.
  - Certified copies (not older than 6 months from the date of certifying) of all qualifications, professional registrations, and training.
  - Letters of completion for previous or current work on appropriate letterhead and signed off by the client must be attached. The letters must detail the scope of work undertaken, project value is undertaken, date of award and completion, and the location where work was carried out.
  - Proof of ownership of the plant or confirmation of rental agreement thereof.
  - Methodology documentation, detailing the bidder's approach to executing the scope of works, risk, and environmental impact.
  - Proof of Contractor Registration issued by the Construction Industry Development Board - Compulsory.
  - Signed Preferencing Schedule, including submitting the supporting documents
    - B-BBEE Verification Certificates issued by a verification agency accredited by the South African National Accreditation System "SANAS" (In the case of a consortium and Joint venture, a Joint BBEE certificate is required, but where sub-contracting only the BBEE of the bidding entity is required). Or in the case of an Exempted Micro Enterprise or a Qualifying Small Enterprise, if permitted in terms of the relevant code,
    - A duly completed and valid affidavit on the relevant form obtained from the DTI website ([https://www.thedti.gov.za/economic\\_empowerment/bee\\_codes.jsp](https://www.thedti.gov.za/economic_empowerment/bee_codes.jsp)). Failure to submit these documents will result in no points allocated.
  - Copy of COIDA (Compensation for Occupational Injuries and Diseases) registration certificate, e.g. Letter of Good Standing

- A valid Tax Clearance, unique security Personal Identification Number(PIN) issued by the South African Revenue Services (where Consortium / Joint Venture / Sub- contractors / Sub-consultants are involved, each party to the association must submit a separate Valid Tax Clearance unique security personal Identification number)
- Certified copy of directors' identity documents not older than six months. No copy of a certified copy will be accepted.
- Joint Venture or Consortium submissions are eligible; Joint Venture Agreement must be notarized by the commissioner of oath.
- Submission of fully Completed and Priced Bill of Quantities.

***KINDLY NOTE THAT FAILURE TO SUBMIT AND OR COMPLETE THE REQUIRED DOCUMENTATION (AS PER MANDATORY REQUIREMENTS INCLUDING COMPLETION OF SBD 1, 4, 6.1, 6.2, 8 and 9) WITH THE TENDER WILL RESULT IN YOUR TENDER BEING REJECTED WITHOUT FURTHER CONSIDERATION.***

**T2.2: RETURNABLE SCHEDULE**

Bidders shall indicate whether the list of returnables has been submitted together with the following completed documents or attachments (by indicating Yes or No)		Complaint	
1.	SBD1: Invitation to Bid	Yes	No
2.	Certificate of Authority	Yes	No
3.	Record of Addenda to the tender	Yes	No
4.	Compulsory Declaration	Yes	No
5.	Preferencing schedule: Broad-based Black Economic Empowerment status	Yes	No
6.	Proposed amendments and qualifications (if applicable)	Yes	No
7.	SBD 4: Declaration of Interest	Yes	No
8.	SBD 6.1: Reference Points claim form in terms of the Preferential Procurement Regulations 2017 or amended	Yes	No
9.	SBD 6.2 Declaration Certificate for Local Production and Content	Yes	No
10.	SBD 8: Declaration of the bidder's past SCM practices	Yes	No
11.	SBD 9: Certificate of Bid determination	Yes	No
12.	Form of offer	Yes	No
13.	CSD	Yes	No
14.	COIDA	Yes	No
15.	Valid tax clearance certificate or tax pin	Yes	No
16.	Certified copy of Contractor Registration for Incorporation or of Company Registration Document	Yes	No
17.	Joint venture certificate (where applicable)	Yes	No
18.	B-BBEE Verification Certificates issued by a verification agency accredited by the South African National Accreditation System (SANAS)	Yes	No
19.	Certified copies of Qualifications, Professional registration, and Training for Key persons	Yes	No
20.	Methodology/Method statement	Yes	No
21.	Certificates or letters of completed or current similar projects, with Contactable references and on the Client's letterhead	Yes	No
22.	Certified copy of directors' identity documents	Yes	No
23.	Minimum CIDB class grading: 6GB or higher.	Yes	No
24.	Preliminary Programme/schedule and cash flow	Yes	No

**PART A**  
**INVITATION TO BID**

**SBD 1**

<b>YOU ARE HEREBY INVITED TO BID FOR REQUIREMENTS OF THE (NAME OF DEPARTMENT/PUBLIC ENTITY)</b>					
BID NUMBER:		<b>CLOSING DATE:</b>		<b>CLOSING TIME:</b>	
DESCRIPTION					
<b>THE SUCCESSFUL BIDDER WILL BE REQUIRED TO FILL IN AND SIGN A WRITTEN CONTRACT FORM (SBD7).</b>					
BID RESPONSE DOCUMENTS MAY BE DEPOSITED IN THE BID BOX SITUATED AT (STREET ADDRESS)					
<b>SUPPLIER INFORMATION</b>					
NAME OF BIDDER					
POSTAL ADDRESS					
STREET ADDRESS					
TELEPHONE NUMBER		CODE		NUMBER	
CELLPHONE NUMBER					
FACSIMILE NUMBER		CODE		NUMBER	
E-MAIL ADDRESS					
VAT REGISTRATION NUMBER					
		TCS PIN:		OR	CSD No:
B-BBEE STATUS LEVEL VERIFICATION CERTIFICATE [TICK APPLICABLE BOX]		<input type="checkbox"/> Yes <input type="checkbox"/> No		B-BBEE STATUS LEVEL SWORN AFFIDAVIT <input type="checkbox"/> Yes <input type="checkbox"/> No	
IF YES, WHO WAS THE CERTIFICATE ISSUED BY?					
AN ACCOUNTING OFFICER AS CONTEMPLATED IN THE CLOSE CORPORATION ACT (CCA) AND NAME THE APPLICABLE IN THE TICK BOX		<input type="checkbox"/> AN ACCOUNTING OFFICER AS CONTEMPLATED IN THE CLOSE CORPORATION ACT (CCA)			
		<input type="checkbox"/> A VERIFICATION AGENCY ACCREDITED BY THE SOUTH AFRICAN ACCREDITATION SYSTEM (SANAS)			
		<input type="checkbox"/> A REGISTERED AUDITOR NAME: _____			
<b>[A B-BBEE STATUS LEVEL VERIFICATION CERTIFICATE/SWORN AFFIDAVIT(FOR EMEs&amp; QSEs) MUST BE SUBMITTED IN ORDER TO QUALIFY FOR PREFERENCE POINTS FOR B-BBEE]</b>					
ARE YOU THE ACCREDITED REPRESENTATIVE IN SOUTH AFRICA FOR THE GOODS /SERVICES /WORKS OFFERED?		<input type="checkbox"/> Yes <input type="checkbox"/> No [IF YES ENCLOSE PROOF]		ARE YOU A FOREIGN BASED SUPPLIER FOR THE GOODS /SERVICES /WORKS OFFERED? <input type="checkbox"/> Yes <input type="checkbox"/> No [IF YES ANSWER PART B:3 BELOW ]	
<b>SIGNATURE OF BIDDER</b>		.....		<b>DATE</b>	
<b>CAPACITY UNDER WHICH THIS BID IS SIGNED (Attach proof</b>					

**BID NO: LDPWRI-B/20115**

<b>of authority to sign this bid; e.g. resolution of directors, etc.)</b>			
<b>TOTAL NUMBER OF ITEMS OFFERED</b>		<b>TOTAL BID PRICE (ALL INCLUSIVE)</b>	
<b>BIDDING PROCEDURE ENQUIRIES MAY BE DIRECTED TO:</b>		<b>TECHNICAL INFORMATION MAY BE DIRECTED TO:</b>	
DEPARTMENT/ PUBLIC ENTITY		CONTACT PERSON	
CONTACT PERSON		TELEPHONE NUMBER	
TELEPHONE NUMBER		FACSIMILE NUMBER	
FACSIMILE NUMBER		E-MAIL ADDRESS	
E-MAIL ADDRESS	ramavhoyag@dpw.limpopo.gov		

ARE YOU THE ACCREDITED REPRESENTATIVE  
 IN SOUTH AFRICA FOR THE GOODS / SERVICES / WORKS OFFERED? YES or NO  
 IF YES ENCLOSE PROOF]

SIGNATURE OF BIDDER .....

DATE.....

CAPACITY UNDER WHICH THIS BID IS SIGNED.....

TOTAL BID PRICE..... TOTAL NUMBER OF ITEMS OFFERED.....

**ANY ENQUIRIES REGARDING THE BIDDING PROCEDURE MAY BE DIRECTED TO:**

Department: .....

Contact Person: .....

Tel: .....

Fax: .....

E-mail address:.....

**ANY ENQUIRIES REGARDING TECHNICAL INFORMATION MAY BE DIRECTED TO:**

Contact Person: .....

Tel: .....

Fax: .....

E-mail address:.....

**PART B  
TERMS AND CONDITIONS FOR BIDDING**

**SBD 1**

<b>1. BID SUBMISSION:</b>	
1.1.	BIDS MUST BE DELIVERED BY THE STIPULATED TIME TO THE CORRECT ADDRESS. LATE BIDS WILL NOT BE ACCEPTED FOR CONSIDERATION.
1.2.	ALL BIDS MUST BE SUBMITTED ON THE OFFICIAL FORMS PROVIDED-(NOT TO BE RE-TYPED) OR ONLINE
1.3.	BIDDERS MUST REGISTER ON THE CENTRAL SUPPLIER DATABASE (CSD) TO UPLOAD MANDATORY INFORMATION NAMELY: (BUSINESS REGISTRATION/ DIRECTORSHIP/ MEMBERSHIP/IDENTITY NUMBERS; TAX COMPLIANCE STATUS; AND BANKING INFORMATION FOR VERIFICATION PURPOSES). B-BBEE CERTIFICATE OR SWORN AFFIDAVIT FOR B-BBEE MUST BE SUBMITTED TO BIDDING INSTITUTION.
1.4.	WHERE A BIDDER IS NOT REGISTERED ON THE CSD, MANDATORY INFORMATION NAMELY: (BUSINESS REGISTRATION/ DIRECTORSHIP/ MEMBERSHIP/IDENTITY NUMBERS; TAX COMPLIANCE STATUS MAY NOT BE SUBMITTED WITH THE BID DOCUMENTATION. B-BBEE CERTIFICATE OR SWORN AFFIDAVIT FOR B-BBEE MUST BE SUBMITTED TO BIDDING INSTITUTION.
1.5.	THIS BID IS SUBJECT TO THE PREFERENTIAL PROCUREMENT POLICY FRAMEWORK ACT 2000 AND THE PREFERENTIAL PROCUREMENT REGULATIONS, 2017, THE GENERAL CONDITIONS OF CONTRACT (GCC) AND, IF APPLICABLE, ANY OTHER LEGISLATION OR SPECIAL CONDITIONS OF CONTRACT.
<b>2. TAX COMPLIANCE REQUIREMENTS</b>	
2.1	BIDDERS MUST ENSURE COMPLIANCE WITH THEIR TAX OBLIGATIONS.
2.2	BIDDERS ARE REQUIRED TO SUBMIT THEIR UNIQUE PERSONAL IDENTIFICATION NUMBER (PIN) ISSUED BY SARS TO ENABLE THE ORGAN OF STATE TO VIEW THE TAXPAYER'S PROFILE AND TAX STATUS.
2.3	APPLICATION FOR TAX COMPLIANCE STATUS (TCS) OR PIN MAY ALSO BE MADE VIA E-FILING. IN ORDER TO USE THIS PROVISION, TAXPAYERS WILL NEED TO REGISTER WITH SARS AS E-FILERS THROUGH THE WEBSITE WWW.SARS.GOV.ZA.
2.4	BIDDERS MAY ALSO SUBMIT A PRINTED TCS TOGETHER WITH THE BID.
2.5	IN BIDS WHERE CONSORTIA / JOINT VENTURES / SUB-CONTRACTORS ARE INVOLVED, EACH PARTY MUST SUBMIT A SEPARATE PROOF OF TCS / PIN / CSD NUMBER.
2.6	WHERE NO TCS IS AVAILABLE BUT THE BIDDER IS REGISTERED ON THE CENTRAL SUPPLIER DATABASE (CSD), A CSD NUMBER MUST BE PROVIDED.
<b>3. QUESTIONNAIRE TO BIDDING FOREIGN SUPPLIERS</b>	
3.1.	IS THE BIDDER A RESIDENT OF THE REPUBLIC OF SOUTH AFRICA (RSA)? <input type="checkbox"/> YES <input type="checkbox"/> NO
3.2.	DOES THE BIDDER HAVE A BRANCH IN THE RSA? <input type="checkbox"/> YES <input type="checkbox"/> NO
3.3.	DOES THE BIDDER HAVE A PERMANENT ESTABLISHMENT IN THE RSA? <input type="checkbox"/> YES <input type="checkbox"/> NO
3.4.	DOES THE BIDDER HAVE ANY SOURCE OF INCOME IN THE RSA? <input type="checkbox"/> YES <input type="checkbox"/> NO
IF THE ANSWER IS "NO" TO ALL OF THE ABOVE, THEN, IT IS NOT A REQUIREMENT TO OBTAIN A TAX COMPLIANCE STATUS / TAX COMPLIANCE SYSTEM PIN CODE FROM THE SOUTH AFRICAN REVENUE SERVICE (SARS) AND IF NOT REGISTER AS PER 2.3 ABOVE.	

**NB: FAILURE TO PROVIDE ANY OF THE ABOVE PARTICULARS MAY RENDER THE BID INVALID.**

AN ACCOUNTING OFFICER AS CONTEMPLATED IN THE CLOSE CORPORATION ACT (CCA).....  
 A VERIFICATION AGENCY ACCREDITED BY THE SOUTH AFRICAN ACCREDITATION SYSTEM (SANAS); OR.....  
 A REGISTERED AUDITOR .....  
 [TICK APPLICABLE BOX]

**(A B-BBEE STATUS LEVEL VERIFICATION CERTIFICATE MUST BE SUBMITTED IN ORDER TO QUALIFY FOR PREFERENCE POINTS FOR B-BBEE)**

**CERTIFICATE OF AUTHORITY**

Indicate the status of the tenderer by ticking the appropriate box hereunder. The tenderer must complete the certificate set out below for the relevant category.

A Company	B Partnership	C Joint Venture	D Sole Proprietor	E Close Corporation

**A. CERTIFICATE FOR COMPANY**

I,....., chairperson of the board of directors of ..... hereby confirm that by resolution of the board (copy attached) taken on .....20...., Mr/Mrs.....acting in the capacity of... .., was authorized to sign all documents in connection with this tender and any contract resulting from it on behalf of the company.

As witness

1.....  
 . Chairperson  
 2.....  
 Date

**B. CERTIFICATE OF PARTNERSHIP**

We, the undersigned, being the key partners in the business trading as ..... hereby authorize Mr/Mrs....., acting in the capacity of.....to sign all documents in connection with the tender forContract... .. and any contract resulting from it on our behalf.

NAME	ADDRESS	SIGNATURE	DATE

NOTE: This certificate is to be completed and signed by all the key partners upon whom rests the direction of the affairs of the Partnership as a whole.

**C. CERTIFICATE FOR JOINT VENTURE**

We, the undersigned, are submitting this tender offer in Joint Venture and hereby authorize Mr/Mrs....., authorized signatory of the company ....., acting in the capacity of lead partner, to sign all documents in connection with the tender offer for Contract... .. and any other contract resulting from it on our behalf.

This authorization is evidenced by the attached power of attorney signed by legally authorized signatories of all the partners to the Joint Venture.

NAME OF FIRM	ADDRESS	AUTHORIZING SIGNATURE, NAME & CAPACITY

**D. CERTIFICATE FOR THE SOLE PROPRIETOR**

I,....., hereby confirm that I am the sole owner of the business trading as.....

As Witness:

1..... Signature: Sole owner  
 2..... Date

**E. CERTIFICATE FOR CLOSE CORPORATION**

We, the undersigned, being the key members in the business trading as.....hereby authorise Mr/Mrs.....acting in the capacity of....., to sign all documents in connection with the tender for Contract... .. and any contract resulting from it on our behalf.

NAME	ADDRESS	SIGNATURE	DATE

NOTE: This certificate is to be completed and signed by all the key members upon whom rests the direction of the affairs of the Close Corporation as a whole



**Record of Addenda to tender documents**

We confirm that the following communications received from the Employer before the submission of this tender offer, amending the tender documents, have been taken into account in this tender offer:

	<b>Date</b>	<b>Title or Details</b>
1.		
2.		
3.		
4.		
5.		
6.		
7.		
8.		
9.		
10.		

Attach additional pages if more space is required.

Signed ..... Date .....

Name ..... Position .....

Tenderer .....

## Compulsory Declaration

The following particulars must be furnished. In the case of a joint venture, a separate declaration in respect of each partner must be completed and submitted.

### Section 1: Enterprise Details

<b>Name of enterprise:</b>	
<b>Contact person:</b>	
<b>Email:</b>	
<b>Telephone:</b>	
<b>Cell no</b>	
<b>Fax:</b>	
<b>Physical address</b>	
<b>Postal address</b>	

### Section 2: Particulars of companies and close corporations

<b>Company / Close Corporation registration number</b>	
--	--

### Section 3: SARS Information

<b>Tax reference number</b>	
<b>VAT registration number:</b>	<i>State Not Registered if not registered for VAT</i>

### Section 4: CIDB registration number

### Section 5: National Treasury Central Supplier Database

<b>Supplier number</b>	
<b>Unique registration reference number</b>	

### Section 6: Particulars of principals

**principal:** means a natural person who is a partner in a partnership, a sole proprietor, a director of a company established in terms of the Companies Act of 2008 (Act No. 71 of 2008) or a member of a close corporation registered in terms of the Close Corporation Act, 1984, (Act No. 69 of 1984).

Attach a separate page if necessary

**Section 7: Record in the service of the state**

Indicate by marking the relevant boxes with a cross, if any principal is currently or has been within the last 12 months in the service of any of the following:

- a member of any municipal council
- a member of any provincial legislature
- a member of the National Assembly or the National Council of Province
- a member of the board of directors of any municipal entity
- an official of any municipality or municipal entity
- an employee of any department, national or provincial public entity or constitutional institution within the meaning of the Public Finance Management Act of 1999 (Act No. 1 of 1999)
- a member of an accounting authority of any national or provincial public entity
- an employee of Parliament or a provincial legislature

**If any of the above boxes are marked, disclose the following:**

Name of principal	Name of institution, public office, board or organ of state and position held	Status of service (tick appropriate column)	
		Current	Within the last 12 months

\*insert separate page if necessary

**Section 8: Record of a family member in the service of the state**

**family member:** a person's spouse, whether in a marriage or in a customary union according to indigenous law, a domestic partner in a civil union, or child, parent, brother, sister, whether such a relationship results from birth, marriage or adoption

Indicate by marking the relevant boxes with a cross, if any family member of a principal as defined in section 5 is currently or has been within the last 12 months been in the service of any of the following:

- a member of any municipal council
- a member of any provincial legislature
- a member of the National Assembly or the National Council of Province
- a member of the board of directors of any municipal entity
- an official of any municipality or municipal entity
- an employee of any provincial department, national or provincial public entity or constitutional institution within the meaning of the Public Finance Management Act, 1999 (Act 1 of 1999)
- a member of an accounting authority of any national or provincial public entity
- an employee of Parliament or a provincial legislature

Name of a family member	Name of institution, public office, board or organ of state and position held	Status of service (tick appropriate column)	
		Current	Within the last 12 m

\*insert separate page if necessary

**Section 9: Record of termination of previous contracts with an organ of state**

Was any contract between the tendering entities including any of its joint venture partners terminated during the past 5 years for reasons other than the employer no longer requiring such works or the employer fails to make payment in terms of the contract.

Yes       No (Tick appropriate box)

If yes, provide particulars (interest separate page if necessary)

**Section 10: Declaration**

The undersigned, who warrants that he/she is duly authorized to do so on behalf of the tendering entity confirms that the contents of this Declaration are within my knowledge, and save where stated otherwise in an attachment hereto, are to the best of my belief both true and correct, and:

- i) neither the name of the tendering entity or any of its principals appears on:
  - a) the Register of Tender Defaulters established in terms of the Prevention and Combating of Corrupt Activities Act of 2004 (Act No. 12 of 2004)
  - b) National Treasury's Database of Restricted Suppliers (see [www.treasury.gov.za](http://www.treasury.gov.za))
- ii) neither the tendering entity of any of its principals has within the last five years been convicted of fraud or corruption by a court of law (including a court outside of the Republic of South Africa);
- iii) any principal who is presently employed by the state has the necessary permission to undertake remunerative work outside such employment (attach permission to this declaration);
- iv) the tendering entity is not associated, linked or involved with any other tendering entities submitting tender offers
- v) has not engaged in any prohibited restrictive horizontal practices including consultation, communication, agreement, or arrangement with any competing or potential tendering entity regarding prices, geographical areas in which goods and services will be rendered, approaches to determining prices or pricing parameters, intentions to submit a tender or not, the content of the submission (specification, timing, conditions of the contract, etc.) or intention to not win a tender;
- vi) has no other relationship with any of the tenderers or those responsible for compiling the scope of work that could cause or be interpreted as a conflict of interest;
- vii) neither the tenderer or any of its principals owes municipal rates and taxes or municipal service charges to any municipality or a municipal entity and are not in arrears for more than 3 months;
- viii) SARS may, on an on-going basis during the term of the contract, disclose the tenderer's tax compliance status to the Employer and when called upon to do so, obtain the written consent of any subcontractors who are subcontracted to execute a portion of the contract that is entered into more than the threshold prescribed by the National Treasury, for SARS to do likewise.

Signed \_\_\_\_\_ Date \_\_\_\_\_

Name \_\_\_\_\_ Position \_\_\_\_\_

*Enterprise* \_\_\_\_\_

NOTE 2: Section 30(1) of the Public Service Act, 1994, prohibits an employee (person who is employed in posts on the establishment of departments) from performing or engaging remunerative work outside his or her employment in the relevant department, except with the written permission of the executive authority of the department. When in operation, Section 8(2) of the Public Administration Management Act, 2014, will prohibit an employee of the public administration (i.e. organs of state and all national departments, national government components listed in Part A of Schedule 3 to the Public Service Act, provincial departments including the office of the premier listed in Schedule 1 of the Public Service Act and provincial departments listed in schedule 2 of the Public Service Act, and provincial government components listed in Part B of Schedule 3 of the Public Service Act) or persons contracted to executive authorities in accordance with the provisions of section 12A of the Public Service Act of 1994 or persons performing similar functions in organs of state from conducting business with the State or to be a director of a public or private company conducting business with the State. The offense for doing so is a fine or imprisonment for a period not exceeding 5 years or both. It is also serious misconduct which may result in the termination of employment by the employer.

NOTE 3: Regulation 44 of Supply Chain Management regulations issued in terms of the Municipal Finance Management Act of 2003 requires that organs of state and municipal entities not award a contract to a person who is the service of the state, a director, manager or principal shareholder in the service of the state or who has been in the service of the state in the previous twelve months.

NOTE 4: Regulation 45 of Supply Chain Management regulations requires a municipality or municipal entity to disclose in the notes to the particulars of the annual statement of any award made to a close family member in the service of the state.

NOTE 5: Corrupt activities which give rise to an offense in terms of the Prevention and Combating of Corrupt Activities Act of 2004) include improperly influencing in any way the procurement of any contract, the fixing of the price, consideration or other amounts of money stipulated or otherwise provided for in any contract and the manipulating by any means of the award of a tender.

NOTE 6: Section 4 of the Competition Act of 1998 prohibits restrictive horizontal practice including agreements between parties in a horizontal relationship that have the effect of substantially preventing or lessening competition, directly or indirectly fixing prices or dividing markets or constitute collusive tendering. Section 5 also prohibits restrictive vertical practices. Any restrictive practices that are suspicious will be reported to the Competition Commission for investigation and possible imposition of administrative penalties.

**F. BROAD-BASED BLACK ECONOMIC EMPOWERMENT**

**Preferencing schedule: Broad-Based Black Economic Empowerment Status**

**Preamble**

Section 10(b) of the Broad-Based Black Economic Empowerment Act of 2003 (Act No. 53 of 2003) states that “Every organ of state and the public entity must take into account and, as far as is reasonably possible, apply any **relevant code of good practice** issued in terms of this Act in developing and implementing a preferential procurement policy.”

A number of codes of good practice have been issued in terms of Section 9(1) of the B-BBEE Act of 2003, including a generic code of good practice and various sector codes. The sector codes vary the metrics, weightings, and targets used in the generic code of good practice to establish the overall performance of an entity and its B-BBEE status. The B-BBEE status needs to be assessed in accordance with the applicable code.

**1 Conditions associated with the granting of preferences**

Tenderers who claim a preference shall provide proof of B-BBEE status level of contributor in accordance with the requirements of section 2 in respect of the applicable code as at the closing time for submissions, failing which their claims for preferences will be rejected.

**1 Proof of B-BBEE status level of contributor**

Proof of B-BBEE status level of contributor shall be by means of

- the B-BBEE status level certificate issued by an authorized body or person;
- an affidavit as prescribed by the B-BBEE Codes of Good Practice; or
- any other requirement prescribed in terms of the Broad-Based Black Economic Empowerment Act

**2 Tender preferences claimed**

The scoring shall be as follows:

B-BBEE status level of contributor	Status level of a tenderer <i>(tick relevant level)</i>	Number of preference points	
		90/10 preference points system	80/20 preference points system
Form not completed or non-complaint contributor		0	0
Level 8 contributor		1	2
Level 7 contributor		2	4
Level 6 contributor		3	6
Level 5 contributor		4	8
Level 4 contributor		5	12
Level 3 contributor		6	14
Level 2 contributor		9	18
Level 1 contributor		10	20

**4 Declaration**

The tenderer declares that

- a) the tendering entity is a level contributor as stated in the submitted proof of B-BBEE status level of a contributor as at the closing date for submissions
- b) the tendering entity has been measured in terms of the following code (tick applicable box):
  - Generic code of good practice
  - Construction Sector Code
  - Other – specify

.....  
.....

- c) the tendering entity confirms that it will only enter into a subcontract with the Employer’s prior approval and is not permitted to subcontract more than 25% of the total of the prices of the contract to any other enterprise that does not have an equal or higher B-BBEE status level of contributor unless the contract is a subcontractor to an Exempted Micro Enterprises which has the capability to execute the contract.
- d) the contents of the declarations made in terms of a) and b) above are within my knowledge and are to the best of my belief both true and correct

The undersigned, who warrants that he/she is duly authorized to do so on behalf of the tenderer, confirms that he/she understands the conditions under which such preferences are granted and confirms that the tenderer satisfies the conditions about the granting of tender preferences.

Signature: .....

Name: .....

Duly authorized to sign on behalf of: .....

Telephone: .....

Fax: ..... Date: .....

Name of witness: ..... Signature of witness: .....

**Note:** 1) Failure to complete the declaration will lead to the rejection of a claim for preference.  
2) Supporting documentation of the abovementioned claim for preference must be submitted with the tender submission to be eligible for a preference

### Proposed amendments and qualifications

The Tenderer should record any deviations or qualifications he may wish to make to the tender documents in this Returnable Schedule. Alternatively, a tenderer may state such deviations and qualifications in a cover letter to his tender and reference such a letter in this schedule.

The Tenderer's attention is drawn to clause 5.8 of SANS 10845-3 regarding the employer's handling of material deviations and qualifications.

Page	Clause or item	Proposal

Signed \_\_\_\_\_ Date \_\_\_\_\_

Name \_\_\_\_\_ Position \_\_\_\_\_

*Tenderer* \_\_\_\_\_



**DECLARATION OF INTEREST**

1. Any legal person, including persons employed by the state<sup>1</sup>, or persons having a kinship with persons employed by the state, including a blood relationship, may make an offer or offers in terms of this invitation to bid (includes a price quotation, advertised competitive bid, limited bid or proposal). In view of possible allegations of favouritism, should the resulting bid, or part thereof, be awarded to persons employed by the state, or to persons connected with or related to them, it is required that the bidder or his/her authorised representative declare his/her position in relation to the evaluating/adjudicating authority where-

- the bidder is employed by the state; and/or
- the legal person on whose behalf the bidding document is signed, has a relationship with persons/a person who are/is involved in the evaluation and or adjudication of the bid(s), or where it is known that such a relationship exists between the person or persons for or on whose behalf the declarant acts and persons who are involved with the evaluation and or adjudication of the bid.

2. **In order to give effect to the above, the following questionnaire must be completed and submitted with the bid.**

2.1 Full Name of bidder or his or her representative: .....

2.2 Identity Number: .....

2.3 Position occupied in the Company (director, trustee, shareholder<sup>2</sup>): .....

2.4 Company Registration Number: .....

2.5 Tax Reference Number: .....

2.6 VAT Registration Number: .....

2.6.1 The names of all directors / trustees / shareholders / members, their individual identity numbers, tax reference numbers and, if applicable, employee / persal numbers must be indicated in paragraph 3 below.

<sup>1</sup>"State" means –

- (a) any national or provincial department, national or provincial public entity or constitutional institution within the meaning of the Public Finance Management Act, 1999 (Act No. 1 of 1999);
- (b) any municipality or municipal entity;
- (c) provincial legislature;
- (d) national Assembly or the national Council of provinces; or
- (e) Parliament.

<sup>2</sup>"Shareholder" means a person who owns shares in the company and is actively involved in the management of the enterprise or business and exercises control over the enterprise.

2.7 Are you or any person connected with the bidder presently employed by the state? **YES / NO**

2.7.1 If so, furnish the following particulars:

Name of person / director / trustee / shareholder/ member: .....

Name of state institution at which you or the person connected to the bidder is employed : .....  
Position occupied in the state institution: .....

Any other particulars:  
.....  
.....  
.....

2.7.2 If you are presently employed by the state, did you obtain the appropriate authority to undertake remunerative work outside employment in the public sector? **YES / NO**

2.7.2.1 If yes, did you attached proof of such authority to the bid document? **YES / NO**

(Note: Failure to submit proof of such authority, where applicable, may result in the disqualification of the bid.

2.7.2.2 If no, furnish reasons for non-submission of such proof:  
.....  
.....  
.....

2.8 Did you or your spouse, or any of the company’s directors / trustees / shareholders / members or their spouses conduct business with the state in the previous twelve months? **YES / NO**

2.8.1 If so, furnish particulars:  
.....  
.....  
.....

2.9 Do you, or any person connected with the bidder, have any relationship (family, friend, other) with a person employed by the state and who may be involved with the evaluation and or adjudication of this bid? **YES / NO**

2.9.1 If so, furnish particulars.  
.....  
.....  
.....

2.10 Are you, or any person connected with the bidder, aware of any relationship (family, friend, other) between any other bidder and any person employed by the state who may be involved with the evaluation and or adjudication of this bid? **YES/NO**

2.10.1 If so, furnish particulars.

.....  
 .....  
 .....

2.11 Do you or any of the directors / trustees / shareholders / members of the company have any interest in any other related companies whether or not they are bidding for this contract? **YES/NO**

2.11.1 If so, furnish particulars:  
 .....  
 .....  
 .....

**3 Full details of directors / trustees / members / shareholders.**

Full Name	Identity Number	Personal Reference Number	Tax Number	State Number / Employee Peral

### **4 DECLARATION**

I, THE UNDERSIGNED (NAME).....

CERTIFY THAT THE INFORMATION FURNISHED IN PARAGRAPHS 2 and 3 ABOVE IS CORRECT.  
I ACCEPT THAT THE STATE MAY REJECT THE BID OR ACT AGAINST ME IN TERMS OF  
PARAGRAPH 23 OF THE GENERAL CONDITIONS OF CONTRACT SHOULD THIS DECLARATION  
PROVE TO BE FALSE.

.....  
Signatu.re

.....  
Date

.....  
Position

.....  
Name of bidder

May 2017

**SBD 6.1**

**PREFERENCE POINTS CLAIM FORM IN TERMS OF THE PREFERENTIAL PROCUREMENT REGULATIONS 2017**

This preference form must form part of all bids invited. It contains general information and serves as a claim form for preference points for Broad-Based Black Economic Empowerment (B-BBEE) Status Level of Contribution

**NB: BEFORE COMPLETING THIS FORM, BIDDERS MUST STUDY THE GENERAL CONDITIONS, DEFINITIONS AND DIRECTIVES APPLICABLE IN RESPECT OF B-BBEE, AS PRESCRIBED IN THE PREFERENTIAL PROCUREMENT REGULATIONS, 2017.**

**1. GENERAL CONDITIONS**

1.1 The following preference point systems are applicable to all bids:

- the 80/20 system for requirements with a Rand value of up to R50 000 000 (all applicable taxes included); and
- the 90/10 system for requirements with a Rand value above R50 000 000 (all applicable taxes included).

- 1.2
- a) The value of this bid is estimated to exceed/not exceed R50 000 000 (all applicable taxes included) and therefore the ..... preference point system shall be applicable; or
  - b) Either the 80/20 or 90/10 preference point system will be applicable to this tender (*delete whichever is not applicable for this tender*).

1.3 Points for this bid shall be awarded for:

- (a) Price; and
- (b) B-BBEE Status Level of Contributor.

1.4 The maximum points for this bid are allocated as follows:

	POINTS
PRICE	
B-BBEE STATUS LEVEL OF CONTRIBUTOR	
Total points for Price and B-BBEE must not exceed	100

1.5 Failure on the part of a bidder to submit proof of B-BBEE Status level of contributor together with the bid, will be interpreted to mean that preference points for B-BBEE status level of contribution are not claimed.

1.6 The purchaser reserves the right to require of a bidder, either before a bid is adjudicated or at any time subsequently, to substantiate any claim in regard to preferences, in any manner required by the purchaser.

## 2. DEFINITIONS

- (a) **“B-BBEE”** means broad-based black economic empowerment as defined in section 1 of the Broad-Based Black Economic Empowerment Act;
- (b) **“B-BBEE status level of contributor”** means the B-BBEE status of an entity in terms of a code of good practice on black economic empowerment, issued in terms of section 9(1) of the Broad-Based Black Economic Empowerment Act;
- (c) **“bid”** means a written offer in a prescribed or stipulated form in response to an invitation by an organ of state for the provision of goods or services, through price quotations, advertised competitive bidding processes or proposals;
- (d) **“Broad-Based Black Economic Empowerment Act”** means the Broad-Based Black Economic Empowerment Act, 2003 (Act No. 53 of 2003);
- (e) **“EME”** means an Exempted Micro Enterprise in terms of a code of good practice on black economic empowerment issued in terms of section 9 (1) of the Broad-Based Black Economic Empowerment Act;
- (f) **“functionality”** means the ability of a tenderer to provide goods or services in accordance with specifications as set out in the tender documents.
- (g) **“prices”** includes all applicable taxes less all unconditional discounts;
- (h) **“proof of B-BBEE status level of contributor”** means:
  - 1) B-BBEE Status level certificate issued by an authorized body or person;
  - 2) A sworn affidavit as prescribed by the B-BBEE Codes of Good Practice;
  - 3) Any other requirement prescribed in terms of the B-BBEE Act;
- (i) **“QSE”** means a qualifying small business enterprise in terms of a code of good practice on black economic empowerment issued in terms of section 9 (1) of the Broad-Based Black Economic Empowerment Act;
- (j) **“rand value”** means the total estimated value of a contract in Rand, calculated at the time of bid invitation, and includes all applicable taxes;

## 3. POINTS AWARDED FOR PRICE

### 3.1 THE 80/20 OR 90/10 PREFERENCE POINT SYSTEMS

A maximum of 80 or 90 points is allocated for price on the following basis:

**80/20    or    90/10**

$$P_s = 80 \left( 1 - \frac{P_t - P_{\min}}{P_{\min}} \right) \quad \text{or} \quad P_s = 90 \left( 1 - \frac{P_t - P_{\min}}{P_{\min}} \right)$$

Where

- $P_s$  = Points scored for price of bid under consideration
- $P_t$  = Price of bid under consideration
- $P_{\min}$  = Price of lowest acceptable bid

**4. POINTS AWARDED FOR B-BBEE STATUS LEVEL OF CONTRIBUTOR**

4.1 In terms of Regulation 6 (2) and 7 (2) of the Preferential Procurement Regulations, preference points must be awarded to a bidder for attaining the B-BBEE status level of contribution in accordance with the table below:

B-BBEE Status Level of Contributor	Number of points (90/10 system)	Number of points (80/20 system)
1	10	20
2	9	18
3	6	14
4	5	12
5	4	8
6	3	6
7	2	4
8	1	2
Non-compliant contributor	0	0

**5. BID DECLARATION**

5.1 Bidders who claim points in respect of B-BBEE Status Level of Contribution must complete the following:

**6. B-BBEE STATUS LEVEL OF CONTRIBUTOR CLAIMED IN TERMS OF PARAGRAPHS 1.4 AND 4.1**

6.1 B-BBEE Status Level of Contributor: . = ..... (maximum of 10 or 20 points)  
 (Points claimed in respect of paragraph 7.1 must be in accordance with the table reflected in paragraph 4.1 and must be substantiated by relevant proof of B-BBEE status level of contributor.)

**7. SUB-CONTRACTING**

7.1 Will any portion of the contract be sub-contracted?

*(Tick applicable box)*

YES		NO	
-----	--	----	--

7.1.1 If yes, indicate:

- i) What percentage of the contract will be subcontracted.....%
- ii) The name of the sub-contractor.....
- iii) The B-BBEE status level of the sub-contractor.....
- iv) Whether the sub-contractor is an EME or QSE

*(Tick applicable box)*

YES		NO	
-----	--	----	--

v) Specify, by ticking the appropriate box, if subcontracting with an enterprise in terms of Preferential Procurement Regulations,2017:

<b>Designated Group: An EME or QSE which is at last 51% owned by:</b>	<b>EME</b> √	<b>QSE</b> √
Black people		
Black people who are youth		
Black people who are women		
Black people with disabilities		
Black people living in rural or underdeveloped areas or townships		
Cooperative owned by black people		
Black people who are military veterans		
<b>OR</b>		
Any EME		
Any QSE		

**8. DECLARATION WITH REGARD TO COMPANY/FIRM**

8.1 Name of company/firm:.....

8.2 VAT registration number:.....

8.3 Company registration number:.....

**8.4 TYPE OF COMPANY/ FIRM**

- Partnership/Joint Venture / Consortium
- One person business/sole propriety
- Close corporation
- Company
- (Pty) Limited

[TICK APPLICABLE BOX]

**8.5 DESCRIBE PRINCIPAL BUSINESS ACTIVITIES**

.....  
 .....  
 .....  
 .....

**8.6 COMPANY CLASSIFICATION**

- Manufacturer
- Supplier
- Professional service provider
- Other service providers, e.g. transporter, etc.

[TICK APPLICABLE BOX]

8.7 Total number of years the company/firm has been in business:.....



8.8 I/we, the undersigned, who is / are duly authorised to do so on behalf of the company/firm, certify that the points claimed, based on the B-BBE status level of contributor indicated in paragraphs 1.4 and 6.1 of the foregoing certificate, qualifies the company/ firm for the preference(s) shown and I / we acknowledge that:

- i) The information furnished is true and correct;
- ii) The preference points claimed are in accordance with the General Conditions as indicated in paragraph 1 of this form;
- iii) In the event of a contract being awarded as a result of points claimed as shown in paragraphs 1.4 and 6.1, the contractor may be required to furnish documentary proof to the satisfaction of the purchaser that the claims are correct;
- iv) If the B-BBEE status level of contributor has been claimed or obtained on a fraudulent basis or any of the conditions of contract have not been fulfilled, the purchaser may, in addition to any other remedy it may have –
  - (a) disqualify the person from the bidding process;
  - (b) recover costs, losses or damages it has incurred or suffered as a result of that person’s conduct;
  - (c) cancel the contract and claim any damages which it has suffered as a result of having to make less favourable arrangements due to such cancellation;
  - (d) recommend that the bidder or contractor, its shareholders and directors, or only the shareholders and directors who acted on a fraudulent basis, be restricted by the National Treasury from obtaining business from any organ of state for a period not exceeding 10 years, after the *audi alteram partem* (hear the other side) rule has been applied; and
  - (e) forward the matter for criminal prosecution.

WITNESSES

1. ....

2. ....

.....  
SIGNATURE(S) OF BIDDERS(S)

DATE: .....

ADDRESS .....

.....

.....

**DECLARATION CERTIFICATE FOR LOCAL PRODUCTION AND CONTENT FOR DESIGNATED SECTORS**

This Standard Bidding Document (SBD) must form part of all bids invited. It contains general information and serves as a declaration form for local content (local production and local content are used interchangeably).

Before completing this declaration, bidders must study the General Conditions, Definitions, Directives applicable in respect of Local Content as prescribed in the Preferential Procurement Regulations, 2017, the South African Bureau of Standards (SABS) approved technical specification number SATS 1286:2011 (Edition 1) and the Guidance on the Calculation of Local Content together with the Local Content Declaration Templates [Annex C (Local Content Declaration: Summary Schedule), D (Imported Content Declaration: Supporting Schedule to Annex C) and E (Local Content Declaration: Supporting Schedule to Annex C)].

**1. General Conditions**

- 1.1. Preferential Procurement Regulations, 2017 (Regulation 8) make provision for the promotion of local production and content.
- 1.2. Regulation 8.(2) prescribes that in the case of designated sectors, organs of state must advertise such tenders with the specific bidding condition that only locally produced or manufactured goods, with a stipulated minimum threshold for local production and content will be considered.
- 1.3. Where necessary, for tenders referred to in paragraph 1.2 above, a two stage bidding process may be followed, where the first stage involves a minimum threshold for local production and content and the second stage price and B-BBEE.
- 1.4. A person awarded a contract in relation to a designated sector, may not sub-contract in such a manner that the local production and content of the overall value of the contract is reduced to below the stipulated minimum threshold.
- 1.5. The local content (LC) expressed as a percentage of the bid price must be calculated in accordance with the SABS approved technical specification number SATS 1286: 2011 as follows:

$$LC = [1 - x / y] * 100$$

Where

- x is the imported content in Rand
- y is the bid price in Rand excluding value added tax (VAT)

Prices referred to in the determination of x must be converted to Rand (ZAR) by using the exchange rate published by South African Reserve Bank (SARB) at 12:00 on the date of advertisement of the bid as indicated in paragraph 4.1 below.

**The SABS approved technical specification number SATS 1286:2011 is accessible on [http://www.thedti.gov.za/industrial development/ip. jsp](http://www.thedti.gov.za/industrial%20development/ip.jsp) at no cost.**

1.6. A bid may be disqualified if this Declaration Certificate and the Annex C (Local Content Declaration: Summary Schedule) are not submitted as part of the bid documentation;

**2. The stipulated minimum threshold(s) for local production and content (refer to Annex A of SATS 1286:2011) for this bid is/are as follows:**

<u>Description of services, works or goods</u>	<u>Stipulated minimum threshold</u>
_____	_____ %
_____	_____ %
_____	_____ %

**3.** Does any portion of the goods or services offered have any imported content?

*(Tick applicable box)*

YES	<input type="checkbox"/>	NO	<input type="checkbox"/>
-----	--------------------------	----	--------------------------

3.1 If yes, the rate(s) of exchange to be used in this bid to calculate the local content as prescribed in paragraph 1.5 of the general conditions must be the rate(s) published by SARB for the specific currency at 12:00 on the date of advertisement of the bid.

The relevant rates of exchange information is accessible on [www.reservebank.co.za](http://www.reservebank.co.za)

Indicate the rate(s) of exchange against the appropriate currency in the table below (refer to Annex A of SATS 1286:2011):

<b>Currency</b>	<b>Rates of exchange</b>
US Dollar	
Pound Sterling	
Euro	
Yen	
Other	

NB: Bidders must submit proof of the SARB rate (s) of exchange used.

3. Where, after the award of a bid, challenges are experienced in meeting the stipulated minimum threshold for local content the dti must be informed accordingly in order for the dti to verify and in consultation with the AO/AA provide directives in this regard.

**LOCAL CONTENT DECLARATION**  
**(REFER TO ANNEX B OF SATS 1286:2011)**

**LOCAL CONTENT DECLARATION BY CHIEF FINANCIAL OFFICER OR OTHER LEGALLY RESPONSIBLE PERSON NOMINATED IN WRITING BY THE CHIEF EXECUTIVE OR SENIOR MEMBER/PERSON WITH MANAGEMENT RESPONSIBILITY (CLOSE CORPORATION, PARTNERSHIP OR INDIVIDUAL)**

**IN RESPECT OF BID NO.** .....

**ISSUED BY:** (Procurement Authority / Name of Institution):  
 .....

NB

- 1 The obligation to complete, duly sign and submit this declaration cannot be transferred to an external authorized representative, auditor or any other third party acting on behalf of the bidder.
- 2 Guidance on the Calculation of Local Content together with Local Content Declaration Templates (Annex C, D and E) is accessible on <http://www.thdti.gov.za/industrialdevelopment/ip.jsp>. Bidders should first complete Declaration D. After completing Declaration D, bidders should complete Declaration E and then consolidate the information on Declaration C. **Declaration C should be submitted with the bid documentation at the closing date and time of the bid in order to substantiate the declaration made in paragraph (c) below.** Declarations D and E should be kept by the bidders for verification purposes for a period of at least 5 years. The successful bidder is required to continuously update Declarations C, D and E with the actual values for the duration of the contract.

I, the undersigned, ..... (full names), do hereby declare, in my capacity as ..... of .....(name of bidder entity), the following:

- (a) The facts contained herein are within my own personal knowledge.
- (b) I have satisfied myself that:
  - (i) the goods/services/works to be delivered in terms of the above-specified bid comply with the minimum local content requirements as specified in the bid, and as measured in terms of SATS 1286:2011; and
- (c) The local content percentage (%) indicated below has been calculated using the formula given in clause 3 of SATS 1286:2011, the rates of exchange indicated in paragraph 4.1 above and the information contained in Declaration D and E which has been consolidated in Declaration C:

Bid price, excluding VAT (y)	R
Imported content (x), as calculated in terms of SATS 1286:2011	R
Stipulated minimum threshold for local content (paragraph 3 above)	
Local content %, as calculated in terms of SATS 1286:2011	

If the bid is for more than one product, the local content percentages for each product contained in Declaration C shall be used instead of the table above.  
The local content percentages for each product has been calculated using the formula given in clause 3 of SATS 1286:2011, the rates of exchange indicated in paragraph 4.1 above and the information contained in Declaration D and E.

- (d) I accept that the Procurement Authority / Institution has the right to request that the local content be verified in terms of the requirements of SATS 1286:2011.
- (e) I understand that the awarding of the bid is dependent on the accuracy of the information furnished in this application. I also understand that the submission of incorrect data, or data that are not verifiable as described in SATS 1286:2011, may result in the Procurement Authority / Institution imposing any or all of the remedies as provided for in Regulation 14 of the Preferential Procurement Regulations, 2017 promulgated under the Preferential Policy Framework Act (PPPFA), 2000 (Act No. 5 of 2000).

**SIGNATURE:** \_\_\_\_\_

**DATE:** \_\_\_\_\_

**WITNESS No. 1** \_\_\_\_\_

**DATE:** \_\_\_\_\_

**WITNESS No. 2** \_\_\_\_\_

**DATE:** \_\_\_\_\_

## **GUIDANCE DOCUMENT FOR THE CALCULATION OF LOCAL CONTENT**

### **1. DEFINITIONS**

Unless explicitly provided in this guideline, the definitions given in SATS 1286:2011 apply.

### **2. GENERAL**

#### **2.1. Introduction**

This guideline provides tenderers with a detailed description of how to calculate local content of products (goods, services and works) by components/material/services and enables them to keep an updated record for verification requirements as per the SATS 1286:2011 Annexure A and B.

The guideline consists of two parts, namely:

- a written guideline; and
- three declarations that must be completed:
  - Declaration C: “Local Content Declaration – Summary Schedule” (see Annexure C);
  - Declaration D: “Imported Content Declaration – Supporting Schedule to Annex C” (see Annexure D); and
  - Declaration E: “Local Content Declaration – Supporting Schedule to Annex C” (see Annexure E).

The guidelines and declarations should be used by tenderers when preparing a tender. A tenderer must complete Declarations D and E, and consolidate the information on Declaration C.

Annexure C must be submitted with the tender by the closing date and time as determined by the Tender Authority. The Tender Authority reserves the right to request that Declarations D and E also be submitted.

If the tender is successful, the tenderer must continuously update Declarations C, D and E with actual values for the duration of the contract.

NOTE:

Annexure A is a note to the purchaser in SATS 1286:2011; and  
Annexure B is the Local Content Declaration IN SATS 1286:2011.

#### **2.2. What is local content?**

According to SATS 1286:2011, the local content of a product is the tender price less the value of imported content, expressed as a percentage. It is, therefore, necessary to first compute the imported value of a product to determine the local content of a product.

#### **2.3. Categories: Imported and Local Content**

The tenderer must differentiate between imported content and local content. Imported content of a product by components/material/services is separated into two categories, namely:

- products imported directly by the tenderer; and
- products imported by a third party and supplied to the tenderer.

### 2.3.1. Imported Content

Identify the imported content, if any, by value for products by component/material/services. In the case of components/materials/services sourced from a South African manufacturer, agent, supplier or subcontractor (i.e. third party), obtain that information and Declaration D from the third party.

Calculate the imported content of components/materials/services to be used in the manufacture of the total quantity of the products for which the tender is to be submitted.

As stated in clause 3.2.4 of SATS 1286:2011: "If information on the origin of components, parts or materials is not available, it will be deemed to be imported content."

#### 2.3.1.1. Imported directly by the tenderer:

When the tenderer import products directly, the onus is on the tenderer to provide evidence of any components/materials/services that were procured from a non-domestic source. The evidence should be verifiable and pertain to the tender as a whole. Typical evidence will include commercial invoices, bills of entry, etc.

When the tenderer procures imported services such as project management, design, testing, marketing, etc. and makes royalty and lease payments, such payments relating to the tender must be included when calculating imported content.

#### 2.3.1.2. Imported by a third party and supplied to the tenderer:

When the tenderer supplies components/material/services that are imported by any third party (for example, a domestic manufacturer, agent, supplier or subcontractor in the supply chain), the onus is on the tenderer to obtain verifiable evidence from the third party.

The tenderer must obtain Declaration D from all third parties for the related tender. The third party must be requested by the tenderer to continuously update Declaration D. Typical evidence of imported content will include commercial invoices, bills of entry etc.

When a third party procures imported services such as project management, design, testing, marketing etc. and makes royalty and lease payments, such payments relating to the tender must be included when calculating imported content.

#### 2.3.1.3. Exempt Imported Content:

Exemptions, if any, are granted by the Department of Trade and Industry (the dti). Evidence of the exemptions must be provided and included in Annexure D.

### 2.3.2. Local Content

Identify and calculate the local content, by value for products by components/materials/services to be used in the manufacture of the total quantity of the products.



**TREASURY DESIGNATED SECTOR**

Steel Construction Material							
Section	Bill no	Page no	Item no	Description	Unit	Qty	Local content Threshold
Concrete, Formwork&Reinforcement							
2	2	30	13	Steel bar reinforcement of various diameters (100kg/m3)	t	6,24	100%
Mesh/fabric reinforcement							
2	2	30	14	Ref 193 mesh steel reinforcement in concrete walls, etc	m2	623	100%
2	14	62	43	Type 193 fabric reinforcement in concrete bottoms	m2	1	100%
2	14	62	44	Type 617 fabric reinforcement in concrete bottoms	m2	1	100%
Brickwork reinforcement(Foundations)							
2	3	32	4	75mm Wide reinforcement built in horizontally	m	615	100%
2	3	33	5	150mm Wide reinforcement built in horizontally	m	1876	100%
2	3	33	10	30 x 1,6mm Roof tie 1,5m long with one end fixed to timber and other end built into brickwork	No	160	100%
Brickwork reinforcement(Superstructure)							
2	3	33	11	75mm Wide reinforcement	m	893	100%
2	3	33	12	150mm Wide reinforcement	m	1915	100%
							100%
Roof coverings							100%
							100%
2	5	39	1	Roof covering with 25 degrees pitch	m2	776	100%
2	5	39	2	Ridge capping 550mm girth	m	69	100%
2	5	39	3	Valley cappings 550mm girth	m	18	100%
2	5	39	4	Hip capping 550mm girth	m	27	100%
2	5	39	5	Flashings	m2	1	100%

Plates-Push Plates and Kicking Plates (Ironmongery)							
2	9	49	4	DSS4 'Wheelchair' or similiar pictogram on 76mm diameter stainless steel plate	No	2	100%
2	9	49	5	DSS2 'Female' or similiar pictogram on 76mm diameter stainless steel plate	No	2	100%
2	9	49	6	DSS1 'Male' or similiar pictogram on 76mm diameter stainless steel plate	No	3	100%
Fabricated structural steel(Ironmongery)							
2	9	49	9	Overhead surface mounted type door closer with aluminium casing	No	8	100%
2	9	49	11	Approved toilet paper dispenser fixed against wall as per manufacturers specifications	No	7	100%
2	9	49	12	425792 'Kim dry' towel dispenser rail fixed against wall as per manufacturers spec	No	7	100%
2	10	51	1	100mm x 3mm x 4.53kg/m circular hollow section column	t	0.03	100%
2	10	51	2	150 x 150 x 10mm Base plates including 4 no . holes to suite m16 bolts. bolts included	No	2	100%
2	10	51	3	150 x 150 x 10mm Top connector plates including 2 no . holes to suite m16 bolts. bolts included	No	2	100%
2	11	52	1	32mm Grab rail 700mm long with two 80mm return ends bolted	No	4	100%
Fabricated structural steel(Metal work)							
2	11	52	2	2100 x 900mm Steel gate comprising of 75 x 50 x 2mm square tubing outer frame and 20 x 20mm square tubing verticals at 120mm centres	No	5	100%
2	11	53	9	Mutual DS3 CAT2 strongroom door and frame 775 x 1875mm high overall with a mass of 380kg	No	2	100%

Steel door Frames							
2	11	53	3	Frame for door 813 x 2032mm high	No	6	100%
2	11	53	4	Frame for door 813 x 2032mm high and fixed fanlight 305mm high	No	10	100%
2	11	53	5	Frame for door 813 x 2 032mm high	No	8	100%
2	11	53	6	Frame for door 813 x 2032mm high and fixed fanlight 305mm high	No	2	100%
2	11	53	7	Frame for door 914 x 2 032mm high	No	2	100%
2	11	53	8	Frame for door 1 511 x 2 032mm high	No	1	100%
Steel windows							
2	11	53	10	Window type NE1, 533 x 654mm high	No	8	100%
2	11	54	11	Window type NCT1S, 533 X 949mm high	No	3	100%
2	11	54		Window type ND2, 1022 x 1245mm high	No	17	100%
2	11	54	12	Window type ND4, 1511 x 1245mm high	No	8	100%
2	11	54	13	Window type NE8, 1022 x 654mm high	No	6	100%
2	11	54	14	Window type NG2, 1022 x 359mm high	No	6	100%
Gutters,Downpipe and Lauders							
2	14	58	1	100 x 75mm Rainwater pipes	m	159	100%
2	14	58	2	Extra over gutter for stopped end	No	2	100%
2	14	58	3	Extra over gutter for angle	No	2	100%
2	14	58	4	Extra over gutter for outlet for 75 x 75mm pipe	No	13	100%
2	14	58	5	75 x 75mm diameter rainwater pipes fixed to columns, etc	m	36	100%
2	14	58	6	Extra over rainwater pipe for bend	No	26	100%
2	14	58	7	Extra over rainwater pipe for eaves or plinth offset	No	13	100%
2	14	58	8	Extra over rainwater pipes for shoe	No	13	100%

Plastic pipes							
Section	Bill no	Page no	Item no	Description	Unit	Qty	Local content Threshold
PVC pipes							
2	14	61	29	50mm Pipes fixed to walls, etc.	m	48	100%
2	14	61	30	110mm Pipes fixed to walls, etc.	m	16	100%
2	14	61	31	110mm Pipes laid in and including trenches not exceeding 1m deep	m	180	100%
2	14	61	32	50mm Bend	No	20	100%
2	14	61	33	50mm Access bend	No	5	100%
2	14	61	34	110mm Bend	No	24	100%
2	14	61	35	110mm Tee junction	No	10	100%
2	14	61	36	110 x 50 mm Reducing junction	No	5	100%

Valves products and acutors							
Section	Bill no	Page no	Item no	Description	Unit	Qty	Local content Threshold
Taps&Valves							
2	14	60	21	15mm Chromium plated full way ballcock shut-off control valve with screw type control	No	2	100%
2	14	60	22	15mm Brass stopcock	No	28	100%
2	14	60	23	15mm Chromium sink mixer (Code 266/04/10)	No	1	100%
2	14	60	24	Selene 953, pillartap	No	21	100%

**3. ANNEXURE C**

**3.1. Guidelines for completing Annexure C: Local Content Declaration – Summary Schedule**

*Note: The paragraph numbers correspond to the numbers in Annexure C.*

**C1. Tender Number**

Supply the tender number that is specified on the specific tender documentation.

**C2. Tender description**

Supply the tender description that is specified on the specific tender documentation.

**C3. Designated products**

Supply the details of the products that are designated in terms of this tender (i.e. buses).

**C4. Tender Authority**

Supply the name of the tender authority.

**C5. Tendering Entity name**

Provide the tendering entity name (for example, Unibody Bus Builders (Pty) Ltd).

**C6. Tender Exchange Rate**

Provide the exchange rate used for this tender, as per the Standard Bidding Document (SBD) and Standard Bidding Document (SBD) 6.2.

**C7. Specified local content %**

Provide the specified minimum local content requirement for the tender (i.e. 80%), as per the Standard Bidding Document (SBD) and Municipal Bidding Document (MDB) 6.2.

**C8. Tender item number**

Provide the tender item number(s) of the products that have a local content requirement as per the tender specification.

**C9. List of items**

Provide a list of the item(s) corresponding with the tender item number. This may be a short description or a brand name.

**Calculation of local content**

**C10. Tender price**

Provide the unit tender price of each item excluding VAT.

**C11. Exempted imported content**

Provide the ZAR value of the exempted imported content for each item, if applicable. These value(s) must correspond with the value(s) of column D16 on Annexure D.

**C12. Tender value net of exempted imported content**

Provide the net tender value of the item, if applicable, by deducting the exempted imported content (C11) from the tender price (C10).

**C13. Imported value**

Provide the ZAR value of the items' imported content.

**C14. Local value**

Provide the local value of the item by deducting the Imported value (C13) from the net tender value (C12).

**C15. Local content percentage (per item)**

Provide the local content percentage of the item(s) by dividing the local value (C14) by the net tender value (C12) as per the local content formula in SATS 1286.

**Tender Summary**

**C16. Tender quantity**

Provide the tender quantity for each item number as per the tender specification.

**C17. Total tender value**

Provide the total tender value by multiplying the tender quantity (C16) by the tender price (C10).

**C18. Total exempted imported content**

Provide the total exempted imported content by multiplying the tender quantity (C16) by the exempted imported content (C11). These values must correspond with the values of column D18 on Annexure D.

**C19. Total imported content**

Provide the total imported content of each item by multiplying the tender quantity (C16) by the imported value (C13).

**C20. Total tender value**

Total tender value is the sum of the values in column C17.

**C21. Total exempted imported content**

Total exempted imported content is the sum of the values in column C18. This value must correspond with the value of D19 on Annexure D.

**C22. Total tender value net of exempted imported content**

The total tender value net of exempt imported content is the total tender value (C20) less the total exempted imported content (C21).

**C23. Total imported content**

Total imported content is the sum of the values in column C19. This value must correspond with the value of D53 on Annexure D.

**C24. Total local content**

Total local content is the total tender value net of exempted imported content (C22) less the total imported content (C23). This value must correspond with the value of E13 on Annexure E.

**C25. Average local content percentage of tender**

The average local content percentage of tender is calculated by dividing total local content (C24) by the total tender value net of exempted imported content (C22).

#### 4. ANNEXURE D

##### 4.1. Guidelines for completing Annexure D: “Imported Content Declaration – Supporting Schedule to Annexure C”

*Note: The paragraph numbers correspond to the numbers in Annexure D.*

- D1. Tender number**  
Supply the tender number that is specified on the specific tender documentation.
- D2. Tender description**  
Supply the tender description that is specified on the specific tender documentation.
- D3. Designated products**  
Supply the details of the products that are designated in terms of this tender (i.e. buses).
- D4. Tender authority**  
Supply the name of the tender authority.
- D5. Tendering entity name**  
Provide the tendering entity name (i.e. Unibody Bus Builders (Pty) Ltd).
- D6. Tender exchange rate**  
Provide the exchange rate used for this tender, as per the Standard Bidding Document (SBD) and Standard Bidding Document (SBD) 6.2.

##### **Table A. Exempted Imported Content**

- D7. Tender item number**  
Provide the tender item number(s) of the product(s) that have imported content.
- D8. Description of imported content**  
Provide a list of the exempted imported product(s), if any, as specified in the tender.
- D9. Local supplier**  
Provide the name of the local supplier(s) supplying the imported product(s).
- D10. Overseas supplier**  
Provide the name(s) of the overseas supplier(s) supplying the exempted imported product(s).
- D11. Imported value as per commercial invoice**  
Provide the foreign currency value of the exempted imported product(s) disclosed in the commercial invoice accepted by the South African Revenue Service (SARS).
- D12. Tender exchange rate**  
Provide the exchange rate used for this tender as per the Standard Bidding Document (SBD) and Standard Bidding Document (SBD) 6.2.



**D13. Local value of imports**

Convert the value of the exempted imported content as per commercial invoice (D11) into the ZAR value by using the tender exchange rate (D12) disclosed in the tender documentation.

**D14. Freight costs to port of entry**

Provide the freight costs to the South African Port of the exempted imported item.

**D15. All locally incurred landing costs and duties**

Provide all landing costs including customs and excise duty for the exempted imported product(s) as stipulated in the SATS 1286:2011.

**D16. Total landed costs excluding VAT**

Provide the total landed costs (excluding VAT) for each item imported by adding the corresponding item values in columns D13, D14 and D15. These values must be transferred to column C11 on Annexure C.

**D17. Tender quantity**

Provide the tender quantity of the exempted imported products as per the tender specification.

**D18. Exempted imported value**

Provide the imported value for each of the exempted imported product(s) by multiplying the total landed cost (excl. VAT) (D16) by the tender quantity (D17). The values in column D18 must correspond with the values of column C18 of Annexure C.

**D19. Total exempted imported value**

The total exempted imported value is the sum of the values in column D18. This total must correspond with the value of C21 on Annexure C.

**Table B. Imported Directly By Tenderer**

**D20. Tender item numbers**

Provide the tender item number(s) of the product(s) that have imported content.

**D21. Description of imported content:**

Provide a list of the product(s) imported directly by tender as specified in the tender documentation.

**D22. Unit of measure**

Provide the unit of measure for the product(s) imported directly by the tenderer.

**D23. Overseas supplier**

Provide the name(s) of the overseas supplier(s) supplying the imported product(s).

**D24. Imported value as per commercial Invoice**

Provide the foreign currency value of the product(s) imported directly by tenderer disclosed in the commercial invoice accepted by the South African Revenue Service (SARS).

**D25. Tender rate of exchange**

Provide the exchange rate used for this tender as per the Standard Bidding Document (SBD) and Standard Bidding Document (SBD) 6.2.

**D26. Local value of imports**

Convert the value of the product(s) imported directly by the tenderer as per commercial invoice (D24) into the ZAR value by using the tender exchange rate (D25) disclosed in the tender documentation.

**D27. Freight costs to port of entry**

Provide the freight costs to the South African Port of the product(s) imported directly by the tenderer.

**D28. All locally incurred landing costs and duties**

Provide all landing costs including customs and excise duty for the product(s) imported directly by the tenderer as stipulated in the SATS 1286:2011.

**D29. Total landed costs excluding VAT**

Provide the total landed costs (excluding VAT) for each item imported directly by the tenderer by adding the corresponding item values in columns D26, D27 and D28.

**D30. Tender quantity**

Provide the tender quantity of the product(s) imported directly by the tenderer as per the tender specification.

**D31. Total imported value**

Provide the total imported value for each of the product(s) imported directly by the tenderer by multiplying the total landed cost (excl. VAT) (D29) by the tender quantity (D30).

**D32. Total imported value by tenderer**

The total value of imports by the tenderer is the sum of the values in column D31.

**Table C. Imported by Third Party and Supplied to the Tenderer**

**D33. Description of imported content**

Provide a list of the product(s) imported by the third party and supplied to the tenderer as specified in the tender documentation.

**D34. Unit of measure**

Provide the unit of measure for the product(s) imported by the third party and supplied to tenderer as disclosed in the commercial invoice.

**D35. Local supplier**

Provide the name of the local supplier(s) supplying the imported product(s).

**D36. Overseas supplier**

Provide the name(s) of the overseas supplier(s) supplying the imported products.

**D37. Imported value as per commercial invoice**

Provide the foreign currency value of the product(s) imported by the third party and supplied to the tenderer disclosed in the commercial invoice accepted by SARS.

**D38. Tender rate of exchange**

Provide the exchange rate used for this tender as per the Standard Bidding Document (SBD) and Standard Bidding Document (SBD) 6.2.

**D39. Local value of imports**

Convert the value of the product(s) imported by the third party as per commercial invoice (D37) into the ZAR value by using the tender exchange rate (D38) disclosed in the tender documentation.

**D40. Freight costs to port of entry**

Provide the freight costs to the South African Port of the product(s) imported by third party and supplied to the tenderer.

**D41. All locally incurred landing costs and duties**

Provide all landing costs including customs and excise duty for the product(s) imported by third party and supplied to the tenderer as stipulated in the SATS 1286:2011.

**D42. Total landed costs excluding VAT**

Provide the total landed costs (excluding VAT) for each product imported by third party and supplied to the tenderer by adding the corresponding item values in columns D39, D40 and D41.

**D43. Quantity imported**

Provide the quantity of each product(s) imported by third party and supplied to the tenderer for the tender.

**D44. Total imported value**

Provide the total imported value of the product(s) imported by third party and supplied to the tenderer by multiplying the total landed cost (D42) by the quantity imported (D43).

**D45. Total imported value by third party**

The total imported value from the third party is the sum of the values in column D44.

**Table D. Other Foreign Currency Payments**

**D46. Type of payment**

Provide the type of foreign currency payment. (i.e. royalty payment for use of patent, annual licence fee, etc.).

**D47. Local supplier making the payment**

Provide the name of the local supplier making the payment.

**D48. Overseas beneficiary**

Provide the name of the overseas beneficiary.

**D49. Foreign currency value paid**

Provide the value of the listed payment(s) in their foreign currency.

**D50. Tender rate of exchange**

Provide the exchange rate used for this tender as per the Standard Bidding Document (SBD) and Standard Bidding Document (SBD) 6.2.

**D51. Local value of payments**

Provide the local value of each payment by multiplying the foreign currency value paid (D49) by the tender rate of exchange (D50).

**D52. Total of foreign currency payments declared by tenderer and/or third party**

The total of foreign currency payments declared by tenderer and/or a third party is the sum of the values in column D51.

**D53. Total of imported content and foreign currency payment**

The total imported content and foreign currency payment is the sum of the values in column D32, D45 and D52. This value must correspond with the value of C23 on Annexure C.

## 5. ANNEXURE E

### 5.1. Guidelines to completing Annexure E: “Local Content Declaration-Supporting Schedule to Annexure C”

*The paragraph numbers correspond to the numbers in Annexure E*

- E1. Tender number**  
Supply the tender number that is specified on the specific tender documentation.
- E2. Tender description**  
Supply the tender description that is specified on the specific tender documentation.
- E3. Designated products**  
Supply the details of the products that are designated in terms of this tender (for example, buses/canned vegetables).
- E4. Tender authority**  
Supply the name of the tender authority.
- E5. Tendering entity name**  
Provide the tendering entity name (for example, Unibody Bus Builders (Pty) Ltd) Ltd).

#### **Local Goods, Services and Works**

- E6. Description of items purchased**  
Provide a description of the items purchased locally in the space provided.
- E7. Local supplier**  
Provide the name of the local supplier that corresponds to the item listed in column E6.
- E8. Value**  
Provide the total value of the item purchased in column E6.
- E9. Total local products (Goods, Services and Works)**  
Total local products (goods, services and works) is the sum of the values in E8.
- E10. Manpower costs:**  
Provide the total of all the labour costs accruing only to the tenderer (i.e. not the suppliers to tenderer).
- E11. Factory overheads:**  
Provide the total of all the factory overheads including rental, depreciation and amortisation for local and imported capital goods, utility costs and consumables. (Consumables are goods used by individuals and businesses that must be replaced regularly because they wear out or are used up. Consumables can also be defined as the components of an end product that are used up or permanently altered in the process of manufacturing, such as basic chemicals.)

**E12. Administration overheads and mark-up:**

Provide the total of all the administration overheads, including marketing, insurance, financing, interest and mark-up costs.

**E13. Total local content:**

The total local content is the sum of the values of E9, E10, E11 and E12. This total must correspond with C24 of Annexure C.

**ANNEX C: LOCAL CONTENT DECLARATION – SUMMARY SCHEDULE**

SATS 1286.2011

**Annex C**

**Local Content Declaration - Summary Schedule**

(C1) **Tender No.** LDPWRI-B/20115  
 (C2) **Tender description:** CONSTRUCTION OF THE NEW BAKONE BA MATLALA TRADITIONAL COUNCIL OFFICE  
 (C3) **Designated product(s)** STEEL PRODUCTS AND COMPONENTS FOR CONSTRUCTION  
 (C4) **Tender Authority:**  
 (C5) **Tendering Entity name:** BAKONE BA MATLALA TRADITIONAL COUNCIL  
 (C6) **Tender Exchange Rate:** Pula  EU  GBP   
 (C7) **Specified local content %**

**Note:** VAT to be excluded from all calculations

**Calculation of local content**

Tender item no's	List of items	Tender price - each (excl VAT)	Exempted imported value	Tender value net of exempted imported content	Imported value	Local value	Local content % (per item)	Tender Qty	Total tender value	Total exempted imported content	Total Imported content
2-2-30-13	Steel bar reinforcement of various diameters (100kg/m3)							6.24			
2-2-30-14	Ref 193 mesh steel reinforcement in concrete walls, etc							623			
2-14-62-43	Type 193 fabric reinforcement in concrete bottoms							1			
2-14-62-44	Type 617 fabric reinforcement in concrete bottoms							1			
2-3-32-4	75mm Wide reinforcement built in horizontally							615			
2-3-32-5	150mm Wide reinforcement built in horizontally							1876			
2-3-32-10	30 x 1,6mm Roof tie 1,5m long with one end fixed to timber and other end built into							160			

(C20) Total tender value R 0  
 (C21) Total Exempt imported content R 0  
 (C22) Total Tender value net of exempt imported content R 0  
 (C23) Total Imported content R 0  
 (C24) Total local content R 0  
 (C25) Average local content % of tender

**Signature of tenderer from Annex B**

Date: \_\_\_\_\_

Annex C

Local Content Declaration - Summary Schedule

(C1) Tender No. LDPWRI-B/20115  
 (C2) Tender description: CONSTRUCTION OF THE NEW BAKONE BA MATLALA TRADITIONAL COUNCIL OFFICE  
 (C3) Designated product(s) STEEL PRODUCTS AND COMPONENTS FOR CONSTRUCTION  
 (C4) Tender Authority:  
 (C5) Tendering Entity name: BAKONE BA MATLALA TRADITIONAL COUNCIL  
 (C6) Tender Exchange Rate: Pula  EU  GBP   
 (C7) Specified local content %

Note: VAT to be excluded from all calculations

Tender item no's	List of items	Calculation of local content						Tender summary			
		Tender price - each (excl VAT)	Exempted imported value	Tender value net of exempted imported content	Imported value	Local value	Local content % (per item)	Tender Qty	Total tender value	Total exempted imported content	Total Imported content
(C8)	(C9)	(C10)	(C11)	(C12)	(C13)	(C14)	(C15)	(C16)	(C17)	(C18)	(C19)
2-3-33-11	75mm Wide reinforcement							893			
2-3-33-12	150mm Wide reinforcement							1915			
2-5-39-1	Roof covering with 25 degrees pitch							776			
2-5-39-2	Ridge capping 550mm girth							69			
2-5-39-3	Valley cappings 550mm girth							18			
2-5-39-4	Hip capping 550mm girth							27			
2-5-39-5	Flashings							1			
2-9-49-4	DSS4 'Wheelchair' or similiar pictogram on 76mm diameter stainless steel plate							2			
2-9-49-5	DSS2 'Female' or similiar pictogram on 76mm diameter stainless steel plate							2			
2-9-49-6	DSS1 'Male' or similiar pictogram on 76mm diameter stainless steel plate							3			
2-9-49-9	Overhead surface mounted type door closer with aluminium casing							8			
2-9-49-11	Approved toilet paper dispenser fixed against wall as per manufacturers specifications							7			

(C20) Total tender value R 0

(C21) Total Exempt imported content R 0

(C22) Total Tender value net of exempt imported content R 0

(C23) Total Imported content R 0

(C24) Total local content R 0

(C25) Average local content % of tender

Signature of tenderer from Annex B

Date: \_\_\_\_\_



Annex C

Local Content Declaration - Summary Schedule

(C1) Tender No. LDPWRI-B/20115  
 (C2) Tender description: CONSTRUCTION OF THE NEW BAKONE BA MATLALA TRADITIONAL COUNCIL OFFICE  
 (C3) Designated product(s) STEEL PRODUCTS AND COMPONENTS FOR CONSTRUCTION  
 (C4) Tender Authority:  
 (C5) Tendering Entity name: BAKONE BA MATLALA TRADITIONAL COUNCIL  
 (C6) Tender Exchange Rate: Pula  EU  GBP   
 (C7) Specified local content %

Note: VAT to be excluded from all calculations

Tender item no's	List of items	Calculation of local content						Tender Qty	Total tender value	Total exempted imported content	Total Imported content
		Tender price - each (excl VAT)	Exempted imported value	Tender value net of exempted imported content	Imported value	Local value	Local content % (per item)				
(C8)	(C9)	(C10)	(C11)	(C12)	(C13)	(C14)	(C15)	(C16)	(C17)	(C18)	(C19)
2-9-49-12	425792 'Kim dry' towel dispenser rail fixed against wall as per manufacturers spec							7			
2-10-51-1	100mm x 3mm x 4.53kg/m circular hollow section column							0.03			
2-10-51-2	150 x 150 x 10mm Base plates including 4 no . holes to suite m16 bolts. bolts included							2			
2-10-51-3	including 2 no . holes to suite m16 bolts. bolts included							2			
2-11-52-1	32mm Grab rail 700mm long with two 80mm return ends bolted							4			
2-11-52-2	2100 x 900mm Steel gate comprising of 75 x 50 x 2mm square tubing outer frame and 20 x 20mm							5			
2-11-53-9	Mutual DS3 CAT2 strongroom door and frame 77							2			
2-11-53-3	Frame for door 813 x 2032mm high							6			
2-11-53-4	Frame for door 813 x 2032mm high and fixed fanlight 305mm high							10			
2-11-53-5	Frame for door 813 x 2 032mm high							8			
2-11-53-6	Frame for door 813 x 2032mm high and fixed fanlight 305mm high							2			
2-11-53-7	Frame for door 914 x 2 032mm high							2			

(C20) Total tender value R 0

(C21) Total Exempt imported content R 0

(C22) Total Tender value net of exempt imported content R 0

(C23) Total Imported content R 0

(C24) Total local content R 0

(C25) Average local content % of tender

Signature of tenderer from Annex B

Date: \_\_\_\_\_

### Annex C

#### Local Content Declaration - Summary Schedule

(C1) Tender No. LDPWRI-B/20115  
 (C2) Tender description: CONSTRUCTION OF THE NEW BAKONE BA MATLALA TRADITIONAL COUNCIL OFFICE  
 (C3) Designated product(s) STEEL PRODUCTS AND COMPONENTS FOR CONSTRUCTION  
 (C4) Tender Authority:  
 (C5) Tendering Entity name: BAKONE BA MATLALA TRADITIONAL COUNCIL  
 (C6) Tender Exchange Rate: Pula  EU  GBP   
 (C7) Specified local content %

Note: VAT to be excluded from all calculations

Calculation of local content								Calculation of local content			
Tender item no's	List of items	Tender price - each (excl VAT)	Exempted imported value	Tender value net of exempted imported content	Imported value	Local value	Local content % (per item)	Tender Qty	Total tender value	Total exempted imported content	Total Imported content
(C8)	(C9)	(C10)	(C11)	(C12)	(C13)	(C14)	(C15)	(C16)	(C17)	(C18)	(C19)
2-11-53-8	Frame for door 1 511 x 2 032mm high							1			
2-11-53-10	Window type NE1, 533 x 654mm high							8			
2-11-53-11	Window type NCT1S, 533 X 949mm high							3			
2-11-53-	Window type ND2, 1022 x 1245mm high							17			
2-11-53-12	Window type ND4, 1511 x 1245mm high							8			
2-11-53-13	Window type NE8, 1022 x 654mm high							6			
2-11-53-14	Window type NG2, 1022 x 359mm high							6			
2-14-58-1	100 x 75mm Rainwater pipes							159			
2-14-58-2	Extra over gutter for stopped end							2			
2-14-58-3	Extra over gutter for angle							2			
2-14-58-4	Extra over gutter for outlet for 75 x 75mm pipe							13			

(C20) Total tender value R 0

(C21) Total Exempt imported content R 0

(C22) Total Tender value net of exempt imported content R 0

(C23) Total Imported content R 0

(C24) Total local content R 0

(C25) Average local content % of tender

Signature of tenderer from Annex B

Date: \_\_\_\_\_

Annex C

Local Content Declaration - Summary Schedule

(C1) Tender No. LDPWRI-B/20115  
 (C2) Tender description: CONSTRUCTION OF THE NEW BAKONE BA MATLALA TRADITIONAL COUNCIL OFFICE  
 (C3) Designated product(s) STEEL PRODUCTS AND COMPONENTS FOR CONSTRUCTION  
 (C4) Tender Authority:  
 (C5) Tendering Entity name: BAKONE BA MATLALA TRADITIONAL COUNCIL  
 (C6) Tender Exchange Rate: Pula  EU  GBP   
 (C7) Specified local content %

Note: VAT to be excluded from all calculations

Calculation of local content							
Tender item no's	List of items	Tender price - each (excl VAT)	Exempted imported value	Tender value net of exempted imported content	Imported value	Local value	Local content % (per item)
(C8)	(C9)	(C10)	(C11)	(C12)	(C13)	(C14)	(C15)
2-14-58-5	75 x 75mm diameter rainwater pipes fixed to co						
2-14-58-6	Extra over rainwater pipe for bend						
2-14-58-7	Extra over rainwater pipe for eaves or plinth off						
2-14-58-8	Extra over rainwater pipes for shoe						

Tender Qty	Total tender value	Total exempted imported content	Total Imported content
(C16)	(C17)	(C18)	(C19)
36			
26			
13			
13			

Signature of tenderer from Annex B

Date: \_\_\_\_\_

(C20) Total tender value R 0  
 (C21) Total Exempt imported content R 0  
 (C22) Total Tender value net of exempt imported content R 0  
 (C23) Total Imported content R 0  
 (C24) Total local content R 0  
 (C25) Average local content % of tender

**Annex C**

**Local Content Declaration - Summary Schedule**

(C1) Tender No. LDPWRI-B/20115  
 (C2) Tender description: CONSTRUCTION OF THE NEW BAKONE BA MATLALA TRADITIONAL COUNCIL OFFICE  
 (C3) Designated product(s) PLASTIC PIPES  
 (C4) Tender Authority:  
 (C5) Tendering Entity name: BAKONE BA MATLALA TRADITIONAL COUNCIL  
 (C6) Tender Exchange Rate: Pula  EU  GBP   
 (C7) Specified local content %

**Note:** VAT to be excluded from all calculations

Tender item no's	List of items	Calculation of local content						Tender Qty	Total tender value	Total exempted imported content	Total Imported content
		Tender price - each (excl VAT)	Exempted imported value	Tender value net of exempted imported content	Imported value	Local value	Local content % (per item)				
(C8)	(C9)	(C10)	(C11)	(C12)	(C13)	(C14)	(C15)	(C16)	(C17)	(C18)	(C19)
2-14-61-29	50mm Pipes fixed to walls, etc.							48			
2-14-61-30	110mm Pipes fixed to walls, etc.							16			
2-14-61-31	110mm Pipes laid in and including trenches not exceeding 1m deep							180			
2-14-61-32	50mm Bend							20			
2-14-61-33	50mm Access bend							5			
2-14-61-34	110mm Bend							24			
2-14-61-35	110mm Tee junction							10			
2-14-61-36	110 x 50 mm Reducing junction							5			

(C20) Total tender value  R 0  
 (C21) Total Exempt imported content  R 0  
 (C22) Total Tender value net of exempt imported content  R 0  
 (C23) Total Imported content  R 0  
 (C24) Total local content  R 0  
 (C25) Average local content % of tender

Signature of tenderer from Annex B

Date: \_\_\_\_\_

**Annex C**

**Local Content Declaration - Summary Schedule**

(C1) Tender No. LDPWRI-B/20115  
 (C2) Tender description: CONSTRUCTION OF THE NEW BAKONE BA MATLALA TRADITIONAL COUNCIL OFFICE  
 (C3) Designated product(s) VALVES PRODUCTS AND ACUTORS  
 (C4) Tender Authority:  
 (C5) Tendering Entity name: BAKONE BA MATLALA TRADITIONAL COUNCIL  
 (C6) Tender Exchange Rate: Pula  EU  GBP   
 (C7) Specified local content %

**Note:** VAT to be excluded from all calculations

**Calculation of local content**

Tender item no's	List of items	Tender price - each (excl VAT)	Exempted imported value	Tender value net of exempted imported content	Imported value	Local value	Local content % (per item)	Tender Qty	Total tender value	Total exempted imported content	Total Imported content
(C8)	(C9)	(C10)	(C11)	(C12)	(C13)	(C14)	(C15)	(C16)	(C17)	(C18)	(C19)
2-14-60-21	15mm Chromium plated full way ballcock shut-off control valve with screw type control							2			
2-14-60-22	15mm Brass stopcock							28			
2-14-60-23	15mm Chromium sink mixer (Code 266/04/10)							1			
2-14-60-24	Selene 953, pillartap							21			

Signature of tenderer from Annex B  
 \_\_\_\_\_  
 Date: \_\_\_\_\_

(C20) Total tender value R 0  
 (C21) Total Exempt imported content R 0  
 (C22) Total Tender value net of exempt imported content R 0  
 (C23) Total Imported content R 0  
 (C24) Total local content R 0  
 (C25) Average local content % of tender

**ANNEX D: IMPORTED CONTENT DECLARATION – SUPPORTING SCHEDULE TO ANNEX C**

											SATS 1286.2011	
<b>Annex D</b>												
<b>Imported Content Declaration - Supporting Schedule to Annex C</b>												
(D1)	Tender No.								Note: VAT to be excluded from all calculations			
(D2)	Tender description:											
(D3)	Designated Products:											
(D4)	Tender Authority:											
(D5)	Tendering Entity name:											
(D6)	Tender Exchange Rate:				Pula	EU	GBP					
<b>A. Exempted imported content</b>					<b>Calculation of imported content</b>						<b>Summary</b>	
Tender item no's	Description of imported content	Local supplier	Overseas Supplier	Foreign currency value as per Commercial Invoice	Tender Exchange Rate	Local value of imports	Freight costs to port of entry	All locally incurred landing costs & duties	Total landed cost excl VAT	Tender Qty	Exempted imported value	
(D7)	(D8)	(D9)	(D10)	(D11)	(D12)	(D13)	(D14)	(D15)	(D16)	(D17)	(D18)	
										(D19) Total exempt imported value		R 0
										This total must correspond with Annex C - C 21		
<b>B. Imported directly by the Tenderer</b>					<b>Calculation of imported content</b>						<b>Summary</b>	
Tender item no's	Description of imported content	Unit of measure	Overseas Supplier	Foreign currency value as per Commercial Invoice	Tender Rate of Exchange	Local value of imports	Freight costs to port of entry	All locally incurred landing costs & duties	Total landed cost excl VAT	Tender Qty	Total imported value	
(D20)	(D21)	(D22)	(D23)	(D24)	(D25)	(D26)	(D27)	(D28)	(D29)	(D30)	(D31)	
										(D32) Total imported value by tenderer		R 0

C. Imported by a 3rd party and supplied to the Tenderer					Calculation of imported content						Summary	
Description of imported content	Unit of measure	Local supplier	Overseas Supplier	Foreign currency value as per Commercial Invoice	Tender Rate of Exchange	Local value of imports	Freight costs to port of entry	All locally incurred landing costs & duties	Total landed cost excl VAT	Quantity imported	Total imported value	
(D33)	(D34)	(D35)	(D36)	(D37)	(D38)	(D39)	(D40)	(D41)	(D42)	(D43)	(D44)	
										<b>(D45) Total imported value by 3rd party</b>		R 0
D. Other foreign currency payments				Calculation of foreign currency payments								Summary of payments
Type of payment	Local supplier making the payment	Overseas beneficiary	Foreign currency value paid	Tender Rate of Exchange							Local value of payments	
(D46)	(D47)	(D48)	(D49)	(D50)							(D51)	
										<b>(D52) Total of foreign currency payments declared by tenderer and/or 3rd party</b>		
Signature of tenderer from Annex B										<b>(D53) Total of imported content &amp; foreign currency payments - (D32), (D45) &amp; (D52) above</b>		R 0
Date:										<b>This total must correspond with Annex C - C 23</b>		

**ANNEX E: LOCAL CONTENT DECLARATION – SUPPORTING SCHEDULE TO ANNEX C**

SATS 1286.2011

**Annex E**

**Local Content Declaration - Supporting Schedule to Annex C**

(E1)	Tender No.	
(E2)	Tender description:	
(E3)	Designated products:	
(E4)	Tender Authority:	
(E5)	Tendering Entity name:	

**Note: VAT to be excluded from all calculations**

Local Products (Goods, Services and Works)	Description of items purchased	Local suppliers	Value
	(E6)	(E7)	(E8)
	<b>(E9) Total local products (Goods, Services and Works)</b>		R 0



	(E10)	<b>Manpower costs</b> ( Tenderer's manpower cost)				R 0
	(E11)	<b>Factory overheads</b> (Rental, depreciation & amortisation, utility costs, consumables etc.)				R 0
	(E12)	<b>Administration overheads and mark-up</b> (Marketing, insurance, financing, interest etc.)				R 0
					(E13) Total local content	R 0
					<b>This total must correspond with Annex C - C24</b>	
<b>Signature of tenderer from Annex B</b>						
	Date:					

## SBD 8: DECLARATION OF BIDDER'S PAST SUPPLY CHAIN MANAGEMENT PRACTICES

- 1 This Standard Bidding Document must form part of all bids invited.
- 2 It serves as a declaration to be used by institutions in ensuring that when goods and services are being procured, all reasonable steps are taken to combat the abuse of the supply chain management system.
- 3 The bid of any bidder may be disregarded if that bidder or any of its directors have-
  - a. abused the institution's supply chain management system;
  - b. committed fraud or any other improper conduct concerning such system; or
  - c. failed to perform on any previous contract.
- 4 **To give effect to the above, the following questionnaire must be completed and submitted with the bid.**

Item	Question	Yes	No
4.1	<p>Is the bidder or any of its directors listed on the National Treasury's Database of Restricted Suppliers as companies or persons prohibited from doing business with the public sector?</p> <p><b>(Companies or persons who are listed on this Database were informed in writing of this restriction by the Accounting Officer/Authority of the institution that imposed the restriction after the <i>audi alteram partem</i> rule was applied).</b></p> <p>The Database of Restricted Suppliers now resides on the National Treasury's website(<a href="http://www.treasury.gov.za">www.treasury.gov.za</a>) and can be accessed by clicking on its link at the bottom of the home page.</p>	Yes <input type="checkbox"/>	No <input type="checkbox"/>
4.1.1	If so, furnish particulars:		
4.2	<p>Is the bidder or any of its directors listed on the Register for Tender Defaulters in terms of section 29 of the Prevention and Combating of Corrupt Activities Act (No 12 of 2004)?</p> <p><b>The Register for Tender Defaulters can be accessed on the National Treasury's website (<a href="http://www.treasury.gov.za">www.treasury.gov.za</a>) by clicking on its link at the bottom of the home page.</b></p>	Yes <input type="checkbox"/>	No <input type="checkbox"/>
4.2.1	If so, furnish particulars:		
4.3	<p>Was the bidder or any of its directors convicted by a court of law (including a court outside of the Republic of South Africa) for fraud or corruption during the past five years?</p>	Yes <input type="checkbox"/>	No <input type="checkbox"/>
4.3.1	If so, furnish particulars:		
4.4	<p>Was any contract between the bidder and any organ of state terminated during the past five years on account of failure to perform on or comply with the contract?</p>	Yes <input type="checkbox"/>	No <input type="checkbox"/>
4.4.1	If so, furnish particulars:		

**CERTIFICATION**

I, THE UNDERSIGNED (FULL NAME) .....  
CERTIFY THAT THE INFORMATION FURNISHED ON THIS DECLARATION FORM IS TRUE AND CORRECT.

I ACCEPT THAT, IN ADDITION TO CANCELLATION OF A CONTRACT, ACTION MAY BE TAKEN AGAINST  
ME SHOULD THIS DECLARATION PROVE TO BE FALSE.

.....  
**Signature**

.....  
**Date**

.....  
**Position**

.....  
**Name of Bidder**

## SBD 9: CERTIFICATE OF INDEPENDENT BID DETERMINATION

- 1 This Standard Bidding Document (SBD) must form part of all bids<sup>1</sup> invited.
- 2 Section 4 (1) (b) (iii) of the Competition Act No. 89 of 1998, as amended, prohibits an agreement between, or concerted practice by, firms, or a decision by an association of firms, if it is between parties in a horizontal relationship and if it involves collusive bidding (or bid rigging).<sup>2</sup> Collusive bidding is a *pe se* prohibition meaning that it cannot be justified under any grounds.
- 3 Treasury Regulation 16A9 prescribes that accounting officers and accounting authorities must take all reasonable steps to prevent abuse of the supply chain management system and authorizes accounting officers and accounting authorities to:
  - a. disregard the bid of any bidder if that bidder or any of its directors have abused the institution's supply chain management system and or committed fraud or any other improper conduct concerning such system.
  - b. cancel a contract awarded to a supplier of goods and services if the supplier committed any corrupt or fraudulent act during the bidding process or the execution of that contract.
- 4 This SBD serves as a certificate of declaration that would be used by institutions to ensure that, when bids are considered, reasonable steps are taken to prevent any form of bid-rigging.
- 5 In order to give effect to the above, the attached Certificate of Bid Determination (SBD 9) must be completed and submitted with the bid:

**CERTIFICATE OF INDEPENDENT BID DETERMINATION**

I, the undersigned, in submitting the accompanying bid:

---

(Bid Number and Description)

in response to the invitation for the bid made by:

---

(Name of Institution)

do hereby make the following statements that I certify to be true and complete in every respect:

I certify, on behalf  
of: \_\_\_\_\_ that:

(Name of Bidder)

1. I have read and I understand the contents of this Certificate;
2. I understand that the accompanying bid will be disqualified if this Certificate is found not to be true and complete in every respect;
3. I am authorized by the bidder to sign this Certificate, and to submit the accompanying bid, on behalf of the bidder;
4. Each person whose signature appears on the accompanying bid has been authorized by the bidder to determine the terms of, and to sign the bid, on behalf of the bidder;
5. For this Certificate and the accompanying bid, I understand that the word "competitor" shall include any individual or organization, other than the bidder, whether or not affiliated with the bidder, who:
  - (a) has been requested to submit a bid in response to this bid invitation;
  - (b) could potentially submit a bid in response to this bid invitation, based on their qualifications, abilities or experience; and
  - (c) provides the same goods and services as the bidder and/or is in the same line of business as the bidder
6. The bidder has arrived at the accompanying bid independently from, and without consultation, communication, agreement or arrangement with any competitor. However, communication between partners in a joint venture or consortium<sup>3</sup> will not be construed as collusive bidding.
7. In particular, without limiting the generality of paragraphs 6 above, there has been no consultation, communication, agreement or arrangement with any competitor regarding:
  - (a) prices;
  - (b) the geographical area where product or service will be rendered (market allocation)
  - (c) methods, factors or formulas used to calculate prices;
  - (d) the intention or decision to submit or not to submit, a bid;
  - (e) the submission of a bid which does not meet the specifications and conditions of the bid; or
  - (f) bidding with the intention not to win the bid.

- 8. In addition, there have been no consultations, communications, agreements or arrangements with any competitor regarding the quality, quantity, specifications, and conditions or delivery particulars of the products or services to which this bid invitation relates.
- 9. The terms of the accompanying bid have not been, and will not be, disclosed by the bidder, directly or indirectly, to any competitor, before the date and time of the official bid opening or of the awarding of the contract.
- 10. I am aware that, in addition, and without prejudice to any other remedy provided to combat any restrictive practices related to bids and contracts, bids that are suspicious will be reported to the Competition Commission for investigation and possible imposition of administrative penalties in terms of section 59 of the Competition Act No 89 of 1998 and or may be reported to the National Prosecuting Authority (NPA) for criminal investigation and or may be restricted from conducting business with the public sector for a period not exceeding ten (10) years in terms of the Prevention and Combating of Corrupt Activities Act No 12 of 2004 or any other applicable legislation.

.....  
Signature

.....  
Date

.....  
Position

.....  
Name of Bidder

<sup>1</sup> Includes price quotations, advertised competitive bids, limited bids and proposals.

<sup>2</sup> Bid rigging (or collusive bidding) occurs when businesses, that would otherwise be expected to compete, secretly conspire to raise prices or lower the quality of goods and / or services for purchasers who wish to acquire goods and / or services through a bidding process. Bid rigging is, therefore, an agreement between competitors not to compete.

<sup>3</sup> Joint venture or Consortium means an association of persons for the purpose of combining their expertise, property, capital, efforts, skill, and knowledge in an activity for the execution of a contract.

# SAFCEC JOINT VENTURE AGREEMENT

**JOINT VENTURE AGREEMENT** made and entered into by and between:

.....of  
..... (hereafter referred to as ..... )

of the first part;

and

..... of  
..... (hereafter referred to as ..... )

of the second part;

## PREAMBLE

WHEREAS the Parties have formed a Joint Venture in order to submit tenders to the

..... for the construction of  
.....

(hereafter referred to as the "works").

**NOW THEREFORE, IT IS AGREED AS FOLLOWS:**

**1. FORMATION OF JOINT VENTURE**

- 1.1 The Parties hereby associate themselves into and as a Joint Venture in accordance with the provisions of this Agreement under the style or firm name of ..... JOINT VENTURE.
- 1.2 The Parties hereto agree and undertake that they will not disclose the contents of this Agreement to persons with whom they may have any dealings directly or indirectly arising from the conclusion of this Agreement and the operation and establishment of the Works.
- 1.3 Notwithstanding that the parties may be jointly and severally bound to the ....., should the Joint Venture be awarded the contract by the ..... for the construction of the Works, nothing herein contained shall be interpreted as giving rise to a general partnership between the parties or limiting the rights or powers of either party to carry on its separate business for its sole benefit.

**2. OBJECT AND MOTIVATION**

The sole object for which this Joint Venture is established and the sole business of the Joint Venture is to negotiate for and conclude a contract for the execution of the Works and to carry out such Works to finality, all in accordance with the terms of this Agreement.

**3. PROFITS AND LOSSES**

- 3.1 The profits and losses of the Joint Venture shall be borne by ..... and..... In the proportions .....% and .....% respectively (hereinafter referred to as "the Specified Proportions").
- 3.2 In addition to any other provisions contained in this Agreement, the functions, duties, obligations and responsibilities of ..... and ..... under this Joint Venture agreement and in the execution of the Works will be to provide all bridging finance, guarantees and resources necessary to successfully carry out the project in proportion to the specified proportions, in which proportions all profits, losses, costs, liabilities and assets and any other responsibilities, whether pecuniary or otherwise, shall be shared equally, as far as possible.

**4 DURATION**

The operation of this Agreement shall be deemed to have commenced on the ..... Day of ..... 200..., and shall terminate, except insofar as the provisions of Clauses 5 and 6 apply, upon the happening of any of the following events, whichever shall be earlier:

- 4.1 Award of the Contract by .....for the construction of the Works to an outside party or parties, or
- 4.2 In the case of contract award, at the time the contract is terminated and all rights and obligations of the parties in connection with such contract and in connection with this Agreement have ceased, but in no case before the conclusion of any maintenance period in the contract and the cancellation and/or refund of all guarantees and bonds. The Joint Venture existence shall also be deemed to continue insofar as the Joint Venture is responsible for latent defects under the contract.



**5. EXCLUSIVITY**

The Parties agree and undertake in favour of each other that neither of them shall, except in accordance with the intention expressed in this agreement, be associated in any manner, either directly or indirectly, with any investigation, negotiation, tender or proposal for the performance of or incidental to the execution of the Works and including any variation by way of addition or omission from the scope of the Works or the extension to the Works, nor invest in any company, enterprise or partnership in any manner related thereto, either as previously agreed by the Management Committee in writing.

**6. PRE-CONTRACT COSTS**

- 6.1 All costs incurred by the Parties prior to the ..... day of .....20...., shall be for their own account.
- 6.2 Costs incurred by the Parties after the ..... day of ..... 200... and approved by the Management Committee, shall be borne by the Parties in the Specified Proportions.

**7. MANAGEMENT COMMITTEE**

- 7.1 The day-to-day affairs of the Joint Venture shall be under the control of a Management Committee which shall consist of one representative of each of the parties. Within the terms of this agreement and the contract, if awarded, each such member shall have full authority to bind the party and/or parties he represents in all matters relating to the affairs of the Joint Venture. No party to this agreement may bind the other party hereto without the prior consent of such other party, nor may the Management Committee bind the Joint Venture or any party beyond the terms of this agreement or the contract without the prior written consent of both parties. The parties hereto shall be obliged immediately upon signature of this Agreement, to appoint their representatives and the first meeting of the Management Committee will be held immediately thereafter. The parties shall be obliged at all times to maintain a representative on the Management Committee.
- 7.2 Each representative on the Management Committee shall be entitled to appoint, and from time to time remove and replace, an alternate who shall, at any meeting of the Management Committee at which the representative whom he represents is absent, be vested with all rights and powers and subject to all obligations of the representative whom he represents.
- 7.3 The Chairman at meetings of the Management Committee shall be a representative from ..... and ..... respectively on a six months rotation basis commencing with .....
- 7.4 Meetings of the Management Committee shall take place at such times and places as the Committee shall determine, provided that the Chairman shall be obliged to convene a meeting of the Management Committee not later than 10 days after being required to do so by any one of the parties to this agreement. Not less than five days' notice of any meeting of the Management Committee shall be given to the representatives thereof and their alternates.
- 7.5 Decisions of the Management Committee shall be unanimous, provided that If the representatives or the alternates fail to agree on any decision, the meeting at which that decision is sought shall be adjourned for a period of 24 hours and should the representatives then not agree on the course of action to be taken the matter shall be referred to the Executive Board for a decision. The decision of such Executive Board shall be placed before a further adjourned meeting, which shall take place no later than 72 hours after the initial adjourned meeting and shall bin the Management Committee which shall adopt such decision without variation.
- 7.6 Subject to 7.7 below, decisions on the Management Committee may be reached telephonically, telegraphically, by facsimile or in writing.
- 7.7 Decisions of the Management Committee, whether at a meeting or otherwise, shall be recorded in written minutes which shall be distributed by the Chairman, for the time being to the members of the Management Committee not later than seven days after those decisions have been taken.

Such minutes shall be deemed to have been affirmed unless dissented from not later than seven days after they are deemed to have been received by the dissenter.

- 7.8 The Management Committee may, as it wishes, decide to increase the number of its members for or invite other parties to attend any of its meetings. Such co-opted members or observers shall not have a vote.
- 7.9 The Management Committee shall have the power to delegate such of its powers and duties as it may determine in the best interests of the parties.
- 7.10 No remuneration shall be paid by the Joint Venture to the parties' representatives on the Management Committee in their capacities as such.
- 7.11 The administrative function regarding the operation of the Management Committee shall be fulfilled by the Chairman.

## **8 POWERS OF THE MANAGEMENT COMMITTEE AND DIRECTION OF THE PROJECT MANAGER**

The functions, responsibilities and powers of the Management Committee shall be:

- 8.1 To appoint the Project Manager who shall be nominated by ..... and ..... and who shall attend all meetings of the Management Committee for the implementation of its policies and act only in accordance with its directives and its established procedures. The Project Manager shall be removed in terms of 10 hereof and his successor(s) shall be nominated by ..... and ..... And approved by the Management Committee.
- 8.2 To formulate and dictate to the Project Manager overall policy regarding the following:
  - 8.2.1 The general day-to-day management of the affairs of the Joint Venture.
  - 8.2.2 Representation of the Joint Venture in dealing with the Resident Engineer/ Engineer/ Client and third parties on matters affecting the Joint Venture as a whole.
  - 8.2.3 Co-ordination of the activities of the parties.
  - 8.2.4 Preparation by agreement with the parties and supervision of the programme of the Works.
  - 8.2.5 Ensuring that the responsibility of each of the parties in regard to technical and contractual matters is preserved.
- 8.3 To make such provisions as are necessary to enable the Project Manager to perform his tasks.
- 8.4 To approve the balance sheets and accounts of the Joint Venture.
- 8.5 To approve the tender submitted by the Joint Venture and to approve or withhold approval for and amendment proposed thereto.
- 8.6 To approve the appointment of legal advisers and auditors where such appointments are necessary.
- 8.7 To determine the nature and extend of any additional duties and functions of each of the parties in relation to this Joint Venture.
- 8.8 To determine the terms and conditions of employment of personnel as well as emoluments seconded by the parties to the Joint Venture.
- 8.9 Subject to the terms and conditions of this agreement, to determine and approve:
  - 8.9.1 The amount and type of working capital requirements of the Joint Venture.
  - 8.9.2 All borrowings, guarantees and like obligations undertaken by the parties to the Joint Venture.
  - 8.9.3 The insurance to be taken out by the Joint Venture.

8.9.4 The nature, method and amount of all claims.

8.9.5 When and in what amount to distribute dividends to the parties hereto, save that any decision in terms of which the Joint Venture will undertake further work outside of the original scope of the contract or any variation or amendment of this agreement of the contract, shall require the unanimous agreement of the parties before becoming effective and binding the Joint Venture.

8.9.6 The approval and appointment of all sub-contractors.

## **9 THE EXECUTIVE BOARD**

- 9.1 The Executive Board shall consist of one representative of each of the parties who shall be the Chief Executive Officer of each Joint Venture partner or their nominated deputy but shall not be the same representative as appointed to the Management Committee in terms of Clause 7.1 hereof. The Executive Board shall be the mediation authority of the Joint Venture which shall decide on all issues which are referred to it by the Management Committee as well as on all issues where the Management Committee is not unanimous.
- 9.2 Decisions of the Executive Board, whether original decisions or decisions taken after referral from the Management Committee shall be implemented by the Management Committee as per Clause 7.5.1.
- 9.3 Decisions of the Executive Board shall be unanimous.
- 9.4 Effect shall be given to a resolution arrived at unanimously.
- 9.5 In the event of the Executive Board not being unanimous in its decision the matter is to be referred to arbitration in terms of Clause 16 hereof.
- 9.6 Subject to 9.7 as read in conjunction with 7.7 and, provided that they are unanimous, decisions of the Executive Board may be reached telephonically, telegraphically or in writing. If reached telephonically or otherwise orally such decision must be confirmed in writing within 24 hours.
- 9.7 The Minutes of meetings of the Executive Board shall be handled mutatis mutandis in the manner per Clause 7.7.
- 9.8 The administrative functions regarding the operation of the Executive Board shall be fulfilled by the Chairman of the Management Committee, who shall not be entitled to a voice or a vote at Executive Board meetings.

## **10 PERSONNEL**

- 10.1 The Project Manager shall be appointed as provided in Clause 8.1 hereof.
- 10.2 The person nominated to the office of Project Manager shall be subject to removal from such office by decision of the Management Committee.
- 10.3 All the remuneration and emoluments of employment of the Project Manager shall be an expense of and paid by the Joint Venture, provided that a party shall be entitled by notice in writing delivered to the other parties to elect that the person to be nominated by it to fill the offices of project Manager shall be seconded to the Joint Venture in which event the remuneration and emoluments which would otherwise have been paid to such persons while filling such offices shall be paid to the member responsible for their nomination or otherwise as such member shall direct and subject to such payment being duly and promptly paid to the member or its nominee, the member will hold harmless and keep indemnified the Joint Venture and the other members from all actions, proceedings, claims and demands by such persons or otherwise howsoever in respect of such remuneration and emoluments. The remuneration and emoluments to be paid and allowed by the Joint Venture to the Project Manager shall be

determined from time to time by the Management Committee and borne by the parties hereto in the Specified Propositions.

- 10.4 The members of the Management Committee and Executive Board and their proxies and alternates shall not be employees of the Joint Venture and shall not be entitled to claim any salary or remuneration from the Joint Venture by virtue of such appointments unless the Management Committee shall otherwise decide in writing.
- 10.5 ..... shall be appointed as Secretaries to the Joint Venture. Save for matters pertaining to the works and the contract,..... Shall be consulted on all matters of an administrative and financial nature arising in connection with the business of the Joint Venture where their particular experience, knowledge, facilities and skills in matters of this nature shall be considered to be of benefit to the Joint Venture.

## 11 FINANCING

### 11.1 Working Capital

- 11.1.1 Banking accounts shall be opened in the name of the Joint Venture with banks and at such places as may be determined by it, and the parties shall be responsible for the payment in the Specified Properties of such sums to the credit of such banking accounts as shall from time to time be required by way of working capital for the Joint Venture.
- 11.1.2 Any amounts from time to time advanced by the parties to the Joint Venture in terms of this agreement shall be placed to the credit of their respective capital accounts in the Joint Venture.
- 11.1.3 The banking accounts referred to in sub-clause 11.1.1 hereof shall be operated, and cheques thereon shall be drawn in accordance with the instructions to the bankers in question. Withdrawals from these banking accounts shall be effected on the authority of persons nominated thereto by the Management Committee.
- 11.1.4 Should any party fail to make payment to the Joint Venture of any amount which it is obliged to pay in terms of sub-clause 11.1.1 hereof, after the expiry of a period of seven days from the date of notice requiring it to make such payment, the party to default shall be liable for payment of interest to the other parties on the amount so withheld at the rate of Prime Bank rate charged by Joint Venture Bankers per annum should such other parties have advanced the aforesaid sum.
- 11.1.5 All revenue derived by the Joint Venture from the contract shall forthwith be deposited to the credit of the banking accounts referred to in sub-Clause 1.1.1 hereof.
- 11.1.6 The amount for the time being standing to the credit of the Joint Venture's banking accounts shall be applied:
  - 11.1.6.1 In discharging the obligations of the Joint Venture in accordance with their tenor; provided that the Management Committee shall be entitled to require the payment of any liability prior to its due date if such anticipated payment will result in the allowance by the creditor in question of an advantageous discount to the Joint Venture for prompt payment;
  - 11.1.6.2 As to any surplus of funds for the time being in the said banking account, subject to the agreement of the parties as payment to the parties in the Specified Proportions or in proportion to their participation of the time being in

the Joint Venture, save that any such surplus shall first be utilised for the purpose of eliminating or reducing any disproportion in the ratios of the parties respective capital accounts.

## 11.2 Capital and Advances

11.2.1 The amount of capital required by the Joint Venture to attain its object (and which includes all loans, guarantees, indemnities, reserves) shall be determined from time to time by the Management Committee, and upon being so determined shall forthwith be contributed by the parties to the Joint Venture in the Specified Proportions.

11.2.2 If at any time any party to the Joint Venture shall, due to an emergency or with the consent in writing of the other parties advance any sum of money or to incur any liability on behalf of the Joint Venture over and above its due contribution to capital, then where money has been advanced, the same shall be a debt due from the Joint Venture to the party advancing the money, and shall be repayable on thirty days' notice and shall bear interest at Prime Bank rate as charged by Joint Venture's bankers per annum from date of advance to date of payment. Where a party has incurred a contingent liability on the above basis, the other parties shall, within thirty days of being requested to do so in writing, relieve such party of its obligations thereunder to the extent that the obligations of the parties are in the Specified Proportions.

## 12. ACCOUNTS

12.1 The Joint Venture shall cause proper books of account and complete records to be kept as are customary in the Republic of South Africa relating to all the assets and liabilities of the Joint Venture and expenses incurred or income received by the Joint Venture.

Such book and records shall not be related to the affairs of the parties individually. The said books of account and records, together with all letters, papers or writings concerning or belonging to the Joint Venture shall be kept at site and such other place from time to time as determined by the Management Committee, and each of the parties to the Joint Venture shall at all times have free access and the right to inspect and copy the same.

12.2 Within thirty days of the end of every quarter during the continuance of the Joint Venture, the Joint Venture shall furnish to the Management Committee all necessary documents such as balance sheets, profit and loss accounts, bank balances and comparisons with budget and forecasts of cash flow and profits as are necessary to keep the Management Committee informed of the financial affairs of the Joint Venture. Every such profit and loss account and balance sheet shall be agreed to and signed by the members of the Management Committee on behalf of the Joint Venture members, and when so signed, shall be binding on all the parties, except that if any manifest error therein be detected and pointed out by any party to the others at any time after such signature, such error shall forthwith be rectified.

12.3 After the completion of the contract and the release of all bonds, guarantees and obligations given for the performance of the parties in the Joint Venture, the joint Venture shall procure the preparation and auditing of a final balance sheet and profit and loss account, which shall be approved by the Management Committee, and from which the final profit and loss sustained by the Joint Venture shall be ascertained, and distributed to or contributed by the parties in proportion to their participation in the Joint Venture. This clause shall not be construed as prohibiting the interim distribution of profits or contribution towards losses in the discretion of the Management Committee.

### 13. WINDING UP

Upon the determination of the Joint Venture in accordance with the provisions of this agreement, a full and general account shall be taken of the assets and liabilities of the Joint Venture and of the transactions and dealings thereof, and with all convenient speed, such assets shall be sold and realised and the proceeds applied in paying and discharging such liabilities and the expenses of and incidental to the winding-up of the Joint Venture affairs and thereafter in paying to each Joint Venture member its share of such proceeds in the Specified Proportions. The Joint Venture members respectively undertake to do all such things as may be necessary so as to give effect to the above.

### 14. BREACH

- 14.1 If a party ("the guilty party") shall commit a breach of any material provision of this agreement, and fail to remedy the same within a period of thirty (30) days after the receipt by it of written notice requiring it to do so, or be placed in liquidation or under judicial management, whether provisionally or finally, or propose any compromise with its creditors, the other parties ("the aggrieved parties") shall have the right, without prejudice to any of its other remedies arising from such breach, forthwith to terminate this agreement, in which event:
- 14.2 The guilty party's interest in the joint venture shall be taken over by the remaining parties. The aggrieved parties shall, in addition, have the right, if it so requires, to take over the capital account of the party in default. Such capital account shall be valued on the basis of the nett assets revealed in an audited balance sheet and profit and loss account prepared as at the end of the month in which the default or other breach occurred; provided that the profit and loss account shall take into account the Joint Venture's share in the valuation of the work in progress, as shown in the Joint Venture accounts, at the date of preparation of the balance sheet and profit and loss account, after providing for any known or contemplated future losses to be incurred on the work undertaken or to be undertaken by the Joint Venture and provided further that should upon the completion of the contract or contracts, the provision for losses made in the valuation or work in progress as aforesaid prove to be incorrect, such provisions shall be adjusted. Provided the aggrieved parties have proved that the tender rates as escalated from time to time were inadequate, the guilty party shall be liable to the extent of the participation of such party for all losses incurred on the whole of the contract, including any losses incurred subsequent to the termination of the agreement in accordance with these provisions, but such party shall not be entitled to share in any profits earned subsequent to such termination.
- 14.3 The aggrieved parties shall have the right to recruit in its employment personnel seconded to the Joint Venture by the guilty party and, as a stipulation in favour of such personnel, the guilty party waives any claims it might otherwise have had against such personnel arising from their summary termination of their employment with the guilty party.
- 14.3 All plant hired by the guilty party to the Joint Venture shall remain on hire to and under the control of the aggrieved parties until the completion of the contract, or until the aggrieved parties shall release such plant from the operation of this sub-clause. Payment shall be made thereof monthly.

### 15. DISPUTES

- 15.1 Having regard to the high degree of good faith which must exist between the parties, the parties agree to do their utmost to ensure that the disputes between them are settled equitably and amicably and where possible without resort to arbitration.

15.2 In the event of any differences or dispute of whatever nature arising from this agreement (which shall include any failure to agree on any matter which requires the parties' agreement for the purposes of implementation of this agreement) or any other matter related thereto which cannot be settled by direct negotiation between the parties, such differences or dispute shall be referred to arbitration in terms of Clause 16 hereof.

**16 ARBITRATION**

16.1 Save as hereinafter provided, any dispute at any time between any of the parties hereto in regard to any matter arising out of this agreement or its interpretation or rectification shall be submitted to and decided by arbitration.

16.2 The arbitration referred to in 16.1 shall be held -

16.2.1 At .....

16.2.2 In a summary manner, i.e. on the basis that it shall not be necessary to observe or carry out either -

16.2.2.1 the usual formalities or procedure (e.g. there shall not be any pleadings or discovery); or

16.2.2.2 the strict rules of evidence.

16.2.3 Immediately and with a view to its being completed within twenty-one business days after it is demanded;

16.2.4 Otherwise (but subject to © (d) and (e) under the provisions of the Arbitration Act No. 42 of 1965 or the Republic of South Africa as amended from time to time).

16.3 The Arbitrator shall be, if the question in issue is -

16.3.1 Primarily an accounting matter, an independent accountant;

16.3.2 Primarily a legal matter, a practising Senior Counsel of not than five years standing as such;

16.3.3 Any other matter, an independent person unanimously agreed upon between the parties and failing agreement appointed by the President for the time being of the South African Federation of Civil Engineering Contractors.

16.4 If agreement cannot be reached within seven business days after the arbitration has been demanded as to whether the question in issue falls under 16.3.1, 16.3.2 or 16.3.3, then a practising Senior Counsel of not less than five years' standing as such agreed upon between the parties, and failing agreement appointed by the President for the time being of the ..... Society of Chartered Accountants as soon as possible, thereafter, shall determine whether the question in issue falls under 16.3.1, 16.3.2 or 16.3.3 so that an arbitrator can be appointed, and the arbitration can be held and concluded, if possible, within the prescribed period of twenty-one days.

16.5 The arbitrator shall decide the matters submitted to him according to what he considers just and equitable in the circumstances and, therefore, the strict rules of law need not be observed or be taken into account by him in arriving at his decision.

16.6 The parties irrevocably agree that the decision in those arbitration proceedings -

16.6.1 shall be binding on them;

16.6.2 shall be carried into effect;

16.6.3 can be made an order of any court of competent jurisdiction.

## **17. CONFIDENTIALITY**

17.1 All matters relating to this agreement, any negotiations and the contract for the construction of the Works resulting therefrom shall be regarded by the parties hereto as being highly confidential, and shall not be disclosed without prior written consent of the management Committee to any party, person or entity who or which is not a signatory to this Agreement, except where such disclosure is necessary for the fulfilment of this Agreement.

No party shall at any time hereinafter use any technical information, save that in the public domain, acquired from the other parties hereto except for the purposes of fulfilment of the contract.

17.2 No party shall have the right to advertise, or otherwise permit, the dissemination of publicity concerning its participation in the Joint Venture unless:

17.2.1 the relevant material shall make due reference to and acknowledgement of the work of the other parties;

17.2.2 the relevant material shall, for its dissemination is within the control of the party in question, have been approved by the other parties, which approval shall not be unreasonably withheld.

## **18. ASSIGNMENT**

18.1 No party shall cede, assign or in any other way make over any of its rights or obligations under this agreement without the written consent of the other parties except insofar as such assignment or alienation is to any wholly-owned subsidiary company of that party.

18.2 In the event of such assignment or alienation taking place, the initial party shall jointly and severally and in solidum guarantee the obligations or the assignee towards the remaining parties.

## **19 GENERAL**

19.1 No party shall have a claim against the other parties arising out of a failure to secure the contract, except insofar as the parties are liable to bear the joint venture expenses in the Specified Proportions.

19.2 Any changes and supplementary provisions concerning this agreement shall require the written approval of all the parties hereto.

### **19.3 Variations not effective unless in writing**

No variation, modification or waiver of any provision of this agreement, or consent to any departure therefrom, shall in any event be of any force or effect unless unanimous and confirmed in writing and signed by the parties; then such variation, modification, waiver or consent shall be effective only in the specific instance and for the purpose and to the extent for which made or given.

### **19.4 Additions to the Joint Venture**

No additional parties shall be admitted to the Joint Venture unless the parties to this agreement unanimously agree and subject to the Conditions of Contract for the Works. All sub-contractors



must be approved by the Management Committee in accordance with procedures to be established by the said Committee.

**19.5 Company formation**

Should the parties at any time unanimously agree to form a company to take over the interest of the Joint Venture in the contract and the assets of the joint Venture, the parties undertake to enter into a Shareholders Agreement embodying insofar as it is reasonably possible and practicable the terms hereof and, in addition, including therein a provision affording each party a right of pre-emption to any shares in the company which the other may from time to time wish to dispose of. For the Works the formation of a company shall be subject to the General Conditions of Contract for the Works.

**19.6 Domicilium**

19.6.1 The parties hereto respectively choose domicilium citandi et executandi for all purposes of and in connection with this agreement as follows:

.....  
.....  
.....  
.....

19.6.2 The parties hereto shall be entitled to change their domicilium from time to time, and any such change shall only be effective upon receipt of notice in writing by the other parties of such change.

19.6.3 All payments to be made pursuant to this agreement, and all notices, demands or communications intended for any party, shall be made or given at such party's domicilium for the time being, and if forwarded by prepaid registered post, shall be deemed to have been made or given seven days after the date of posting unless proved to the contrary.

**19.7 Currency**

All amounts referred to in this agreement and all monies payable to or by the parties to the Joint Venture in connection with the Joint Venture shall be both calculated and paid in currencies from time to time and at places to be agreed by the Management Committee.

**19.8 Governing Law**

This agreement shall be construed in accordance with and governed by the laws of Republic of South Africa. The English language version of this agreement shall prevail.

19.9 All correspondence between the parties in regard to this agreement and the contract shall be in the English language.

19.10 Each party shall bear its own costs incurred in the preparation and negotiation of this agreement.

19.11 This agreement over-rides any previous agreement or arrangements concluded between the parties in regard to the works and contract. Notwithstanding the provisions of Clause 19 hereof, the parties agree that any variations to the provision of this agreement and any decisions in terms of which this Joint Venture will undertake further work outside the original scope of the contract referred to earlier, shall require the unanimous agreement of the parties before becoming effective and binding on the parties.

19.12 In the interpretation of this agreement, works in the singular shall include the plural and vice versa as the context may require. The headings to clauses shall not be considered part thereof nor shall the words which they contain be taken into account in the interpretation of any clause.

**THUS DONE AND SIGNED AT .....** **THIS .....****DAY OF**  
**..... 20....**

For and behalf of:

.....

**AS WITNESS:**

- 1. ....
- 2. ....

**THUS DONE AND SIGNED AT .....** **THIS .....****DAY OF**  
**..... 20...**

For and behalf of:

.....

**AS WITNESS:**

- 1. ....
- 2. ....



**THE CONTRACT**

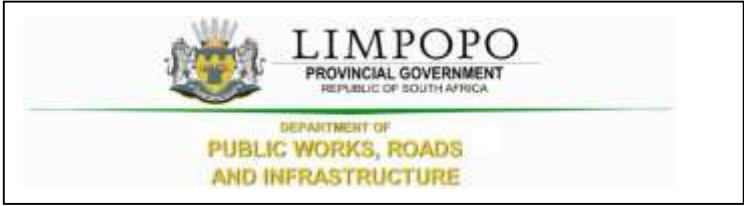

**PART C1: AGREEMENT AND CONTRACT DATA**

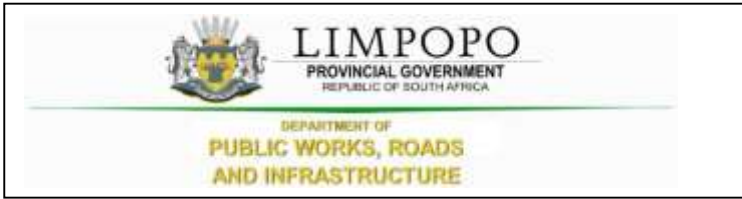

**C1.1. FORM OF OFFER AND ACCEPTANCE**

**Offer**

The employer, identified in the acceptance signature block, has solicited offers to enter into a contract in respect of the following works:

**CONSTRUCTION OF NEW OFFICES AT BAKONE BA MATLALA TRADITIONAL COUNCIL IN THE CAPRICORN DISTRICT.**

The tenderer, identified in the offer signature block, has examined the documents listed in the tender data and addenda thereto as listed in the tender schedules, and by submitting this offer has accepted the conditions of the tender.

By the representative of the tenderer, deemed to be duly authorized, signing this part of the Form of Offer and Acceptance, the tenderer offers to perform all of the obligations and liabilities of the contractor under the contract including compliance with all its terms and conditions according to their true intent and meaning for an amount to be determined in accordance with the conditions of contract identified in the contract data.

**THE OFFERED TOTAL OF THE PRICE INCLUSIVE OF VALUE ADDED TAX IS (CONTRACT PRICE)**

Rand (in words); R .....

..... (in

figures) R.....

This offer may be accepted by the employer by signing the acceptance part of this form of offer and acceptance and returning one copy of this document to the tenderer before the end of the period of validity stated in the tender data, whereupon the tenderer becomes the party named as the contractor in the conditions of contract identified in the contract data.

Signature(s) .....

Name(s) .....

Capacity .....

**For the tenderer:** .....

Name & signature of witness .....

Date

## **Acceptance (To be completed by the employer – not the bidder)**

By signing this part of this Form of Offer and Acceptance, the *Employer* identified below accepts the tenderer's Offer. In consideration thereof, the *Employer* shall pay the Consultant the amount due in accordance with the *conditions of contract* identified in the Contract Data. Acceptance of the tenderer's Offer shall form an agreement between the *Employer* and the tenderer upon the terms and conditions contained in this agreement and in the contract that is the subject of this agreement.

The terms of the contract, are contained in:

- Part C1           Agreements and Contract Data, (which includes this Form of Offer and Acceptance)
- Part C2           Contract Data
- Part C3           Pricing Data
- Part C4           Scope of Work

Any drawings and documents (or parts thereof), which may be incorporated by reference into the above-listed Parts.

Deviations from and amendments to the documents listed in the Tender Data and any addenda thereto listed in the Returnable Schedules as well as any changes to the terms of the Offer agreed by the tenderer and the *Employer* during this process of offer and acceptance, are contained in the Schedule of Deviations attached to and forming part of this Form of Offer and Acceptance. No amendments to or deviations from said documents are valid unless contained in this Schedule.

The tenderer shall within two weeks of receiving a completed copy of this agreement, including the Schedule of Deviations (if any), contact the *Employer's* agent (whose details are given in the Contract Data) to arrange the delivery of any securities, bonds, guarantees, proof of insurance and any other documentation to be provided in terms of the *conditions of contract* identified in the Contract Data. Failure to fulfil any of these obligations in accordance with those terms shall constitute a repudiation of this agreement.

Notwithstanding anything contained herein, this agreement comes into effect on the date when the tenderer receives one fully completed original copy of this document, including the Schedule of Deviations (if any). Unless the tenderer (now *Consultant*) within five working days of the date of such receipt notifies the *Employer* in writing of any reason why he cannot accept the contents of this agreement, this agreement shall constitute a binding contract between the Parties.

### **For the Employer**

Signature .....

Name .....

Capacity .....

### **Name and address of the organization**

### **Signature and Name of Witness**

Signature .....

Name .....

Capacity .....

### Schedule of Deviations

- 1 Subject .....
- Details .....
- .....
- .....
- .....
- .....
  
- 2 Subject .....
- Details .....
- .....
- .....
- .....
  
- 3 Subject .....
- Details .....
- .....
- .....
- .....
  
- 4 Subject .....
- Details .....
- .....
- .....
- .....
- .....

By the duly authorized representatives signing this agreement, the *Employer* and the Tenderer agree to and accept the foregoing schedule of deviations as the only deviations from and amendments to the documents listed in the Tender Data and addenda thereto as listed in the returnable schedules, as well as any confirmation, clarification or changes to the terms of the offer agreed by the Tenderer and the *Employer* during this process of offer and acceptance.

It is expressly agreed that no other matter whether in writing, oral communication or implied during the period between the issue of the tender documents and the receipt by the tenderer of a completed signed copy of this Agreement shall have any meaning or effect in the contract between the parties arising from this agreement.

.....

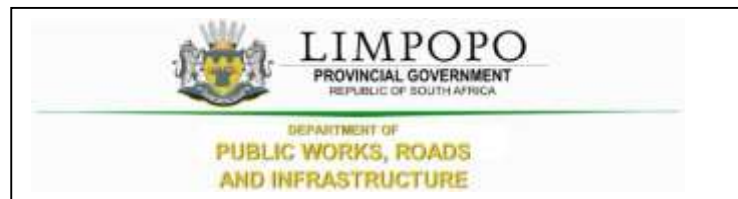

## C2 CONTRACT DATA

The Conditions of Contract are clauses 1 to 41 of the **JBCC Series 2000 Principal Building Agreement (Edition 4.1 of March 2005)** published by the Joint Building Contracts Committee.

Copies of these conditions of contract may be obtained from the Association of South African Quantity Surveyors (011-3154140), Master Builders Association (011-205-9000; 057-3526269) South African Association of Consulting Engineers (011-4632022) or South African Institute of Architects (051-4474909; 011-4860684; 053-8312003;)

The JBCC Principal Building Agreement makes several references to the Contract Data for specific data, which together with these conditions collectively describe the risks, liabilities, and obligations of the contracting parties and the procedures for the administration of the Contract. The Contract Data shall have precedence in the interpretation of any ambiguity or inconsistency between it and the JBCC Principal Building Agreement.





## PART C3: PRICING DATA

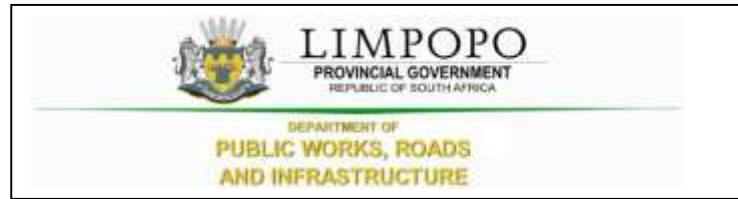

### **C3.1 PRICING INSTRUCTION**

- The Bills of Quantities have been drawn up in accordance with the Standard System of Measuring Building Work in accordance with the provisions of the Model Bills of Quantities or Electrical Work, published by the South African Association of Quantity Surveyors, (July 2005).
- The agreement is under the JBCC N/S Subcontractor Agreement for use with the JBCC PBA (Edition 4.1 code 2101 March 2005) form of contract with Preliminaries (Code 2103 May 2005) incorporating the State Provisions of cl 41.0.
- It will be assumed that prices included in the Bills of Quantities are based on Acts, Ordinances, Regulations, By-laws, International Standards and National Standards that were published 28 days before the closing date for tenders.
- The prices and rates in these Bills of Quantities are fully inclusive prices for the work described under the items. Such prices and rates cover all costs and expenses that may be required in and for the execution of the work described in accordance with the provisions of the Scope of Works and shall cover the cost of all general risks, liabilities, and obligations set forth or implied in the Contract Data, as well as overhead charges and profit. These prices will be used as a basis for the assessment of payment for additional work that may have to be carried out.
- The drawings listed in the Scope of Works used for the setting up of these Bills of Quantities are kept by the Main Contractor and can be viewed at any time during office hours up until the completion of the works.
- An item against which no price is entered will be considered to be covered by the other prices or rates in the Bills of Quantities. A single lump sum will apply should a number of items be grouped together for pricing purposes.
- The Contract Data and the standard form of contract referenced therein must be studied for the full extent and meaning of each and every clause set out in Section 1 (Preliminaries) of the Bills of Quantities.
- The Bills of Quantities is not intended for the ordering of materials. Any ordering of materials, based on the Bills of Quantities, is at the Contractor's risk.

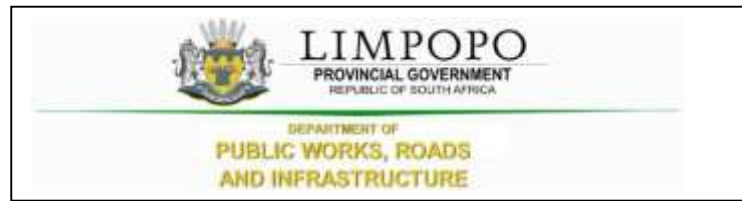

## PART C4: PROVISIONAL BILLS OF QUANTITIES

Item No		Quantity	Rate	Amount
	<b><u>BILL NO. 1</u></b>			
	<b><u>PRELIMINARIESNOTES</u></b>			
	<b><u>SECTION NO.1</u></b>			
	i) The agreement is to be the JBCC Series 2000 Principal Building Agreement (Edition 4.1 Code 2101 March 2005) prepared by the Joint Building Contracts Committee			
	ii) The preliminaries are to be the JBCC Series 2000 Preliminaries prepared by the Joint Building Contracts Committee, Code 2103 May 2005 Edition and shall be deemed to be incorporated herein			
	iii) Tenderers are referred to the abovementioned documents for the full intent and meaning of each clause thereof (hereinafter referred to by heading and clause number only) for which such allowance must be made as may be considered necessary			
	iv) Where standard clauses or alternatives are not entirely applicable to this contract such modifications, corrections or supplements as will apply are given under each relevant clause heading			
	v) Where any item is not relevant to this specific contract such item is marked N/A (signifying "not applicable")			
	vi) If Alternative A as set out in clause B10.3 hereinafter is to be used for the adjustment of the preliminaries each item priced is to be allocated to one or more of the three categories, where "F" denotes a fixed amount (amount not to be varied), "V" denotes an amount variable in proportion to value and "T" denotes an amount in proportion to time			
	<b>SECTION A: PRINCIPAL BUILDING AGREEMENT READ IN CONJUNCTION WITH THE CONTRACT DATA</b>			
	<b>Carried to Collection</b>			
	Section No. 1 Bill No. 1 Preliminaries			
	<b>CONSTRUCTION OF NEW MATLALA TRADITIONAL COUNCIL OFFICE FOR DEPARTMENT OF COOPERATIVE GOVERNANCE HUMAN SETTLEMENTS &amp;</b>			
			R	

**Definitions (A1)**

1 Definitions and interpretation (clause 1)

F:..... V:..... T:.....

Item

**Objective (A2)**

2 Offer acceptance and performance (clause 2)

F:..... V:..... T:.....

Item

**Preparation (A3-A14)**

3 Documents (clause 3)

F:..... V:..... T:.....

Item

4 Design responsibility (clause 4)

F:..... V:..... T:.....

Item

5 Employer's agents (clause 5)

F:..... V:..... T:.....

Item

6 Site representative (clause 6)

F:..... V:..... T:.....

Item

7 Compliance with regulations (clause 7)

F:..... V:..... T:.....

Item

8 Works risk (clause 8)

F:..... V:..... T:.....

Item

9 Indemnities (clause 9)

F:..... V:..... T:.....

Item

10 Works insurance (clause 10)

F:..... V:..... T:.....

Item

**Carried to Collection**

R

Section No. 1  
 Bill No. 1  
 Preliminaries

**CONSTRUCTION OF NEW MATLALA TRADITIONAL COUNCIL OFFICE  
 FOR DEPARTMENT OF COOPERATIVE GOVERNANCE HUMAN SETTLEMENTS &**

11	Liability insurances (clause 11) F:..... V:..... T:.....	Item
12	Effecting insurance (clause 12) F:..... V:..... T:.....	Item
13	No clause (clause 13) F:..... V:..... T:.....	Item
14	Security (clause 14) F:..... V:..... T:.....	Item
<b><u>Execution (A15-A22)</u></b>		
15	Preparation for and execution of the works (clause 15) F:..... V:..... T:.....	Item
16	Access to the works (clause 16) F:..... V:..... T:.....	Item
17	Contract instructions (clause 17) F:..... V:..... T:.....	Item
18	Assignment (clause 19) F:..... V:..... T:.....	Item
19	Setting out of the works (clause 18) F:..... V:..... T:.....	Item

Carried to Collection

R

Section No. 1  
Bill No. 1  
Preliminaries

**CONSTRUCTION OF NEW MATLALA TRADITIONAL COUNCIL OFFICE  
FOR DEPARTMENT OF COOPERATIVE GOVERNANCE HUMAN SETTLEMENTS &**

The contractor shall notify the principal agent if any encroachments of adjoining foundations, buildings, structures, pavements, boundaries, etc. exist in order that the necessary arrangements may be made for the rectification of any such encroachments.

20 Nominated subcontractors (clause 20)  
 F:..... V:..... T:.....

Item

21 Selected subcontractors (clause 21)  
 F:..... V:..... T:.....

Item

22 Employer's Direct Contractors (clause 22)  
 F:..... V:..... T:.....

Item

23 Contractor's Domestic Sub-Contractors (Clause 23)  
 F:..... V:..... T:.....

Item

**Completion (A24-A30)**

24 Practical completion (clause 24)  
 F:..... V:..... T:.....

Item

25 Works completion (clause 25)  
 F:..... V:..... T:.....

Item

26 Final completion (clause 26)  
 F:..... V:..... T:.....

Item

27 Latent defects liability period (clause 27)  
 F:..... V:..... T:.....

Item

**Carried to Collection**

R

Section No. 1  
 Bill No. 1  
 Preliminaries

**CONSTRUCTION OF NEW MATLALA TRADITIONAL COUNCIL OFFICE  
 FOR DEPARTMENT OF COOPERATIVE GOVERNANCE HUMAN SETTLEMENTS &**

28	Sectional completion (clause 28) F:..... V:..... T:.....	Item
29	Revision of date of practical completion (clause 29) F:..... V:..... T:.....	Item
30	Penalty for non-completion (clause 30) F:..... V:..... T:.....	Item
<b><u>Payment (A31 - A35)</u></b>		
31	Interim payment to the contractor (clause 31) F:..... V:..... T:.....	Item
32	Adjustment to the contract value (clause 32) F:..... V:..... T:.....  Notwithstanding the provisions of clause 32.13 fluctuations in costs shall not be adjusted as per heyillet formular (CPA)	Item
33	Recovery of expense and loss (clause 33) F:..... V:..... T:.....	Item
34	Final account and final payment (clause 34) F:..... V:..... T:.....	Item
35	Payment to other parties (clause 35) F:..... V:..... T:.....	Item

**Carried to Collection**

R

Section No. 1  
Bill No. 1  
Preliminaries

**CONSTRUCTION OF NEW MATLALA TRADITIONAL COUNCIL OFFICE  
FOR DEPARTMENT OF COOPERATIVE GOVERNANCE HUMAN SETTLEMENTS &**



**Cancellation (A36-A39)**

36 Cancellation by employer - contractor's default (clause 36)

F:..... V:..... T:.....

Item

37 Cancellation by employer - loss and damage (clause 37)

F:..... V:..... T:.....

Item

38 Cancellation by contractor - employer's default (clause 38)

F:..... V:..... T:.....

Item

39 Cancellation - cessation of the works (clause 39)

F:..... V:..... T:.....

Item

**Dispute (A40)**

40 Settlement of disagreements and disputes (clause 40)

F:..... V:..... T:.....

Item

**Contract variables (A41)**

41 The schedule:Pre-tender information (clause 41)

F:..... V:..... T:.....

Item

Information necessary for completion of those clauses contained in the schedule which are necessary for tender purposes is given hereunder

**Carried to Collection**

R

Section No. 1  
 Bill No. 1  
 Preliminaries

**CONSTRUCTION OF NEW MATLALA TRADITIONAL COUNCIL OFFICE  
 FOR DEPARTMENT OF COOPERATIVE GOVERNANCE HUMAN SETTLEMENTS &**

**41.1.1**

**Employer:**

**DEPARTMENT OF PUBLIC WORKS LIMPOPO**

Postal Address:  
Private Bag x 9490  
POLOKWANE  
0700

Physical Address:  
43 Church Street  
Polokwane  
0699

Tel . (015) 284-7000 Fax (015) 284 7044  
E-mail :

**41.1.2**

**Principal Agent:**

**DEPARTMENT OF PUBLIC WORKS LIMPOPO**

Postal Address:  
Private Bag x 9490  
POLOKWANE  
0700

Physical Address:  
43 Church Street  
Polokwane  
0699

Tel . (015) 284-7000 Fax (015) 284 7044  
E-mail :

**Carried to Collection**

R

Section No. 1  
Bill No. 1  
Preliminaries

**CONSTRUCTION OF NEW MATLALA TRADITIONAL COUNCIL OFFICE  
FOR DEPARTMENT OF COOPERATIVE GOVERNANCE HUMAN SETTLEMENTS &**

**41.1.3****Other Agents: Architect****DEPARTMENT OF PUBLIC WORKS LIMPOPO**

Postal Address:  
Private Bag x 9490  
POLOKWANE  
0700

Physical Address:  
43 Church Street  
Polokwane  
0699

Tel . (015) 284-7000 Fax (015) 284 7044  
E-mail :

**41.1.4****Other Agents : Quantity Surveyors****DEPARTMENT OF PUBLIC WORKS LIMPOPO**

Postal Address:  
Private Bag x 9490  
POLOKWANE  
0700

Physical Address:  
43 Church Street  
Polokwane  
0699

Tel . (015) 284-7000 Fax (015) 284 7044  
E-mail :

**41.2 CONTRACT DETAILS****41.2.1 Works Description:**

The work consist of the construction of a new single storey library building approximately 950m2 and site works

**Carried to Collection**

R

Section No. 1  
Bill No. 1  
Preliminaries

**CONSTRUCTION OF NEW MATLALA TRADITIONAL COUNCIL OFFICE  
FOR DEPARTMENT OF COOPERATIVE GOVERNANCE HUMAN SETTLEMENTS &**

41.2.2 Site Description:

The site is at

41.2.3 Work for installation by direct contractors:

N/A

41.2.4 This agreement is for a government contract:  
contract where there are specific option that  
are

applicable to a state organ only

Yes

41.2.5 Date on which possession of the site is intended  
to be given:

Approximately within 14 (fourteen) calender  
days from the date of the letter of acceptance

41.2.6 Period for the commencement of the works is  
immediately after the contractor takes possession of  
the site

41.2.7 Completion in sections are required

No

41.2.8 Intended date of practical completion and the  
penalty per calender day for the works as a  
whole:

8 calendar months from the date of the  
possession of the site and penalties will be  
0.05% of the contract sum

**Carried to Collection**

R

Section No. 1  
Bill No. 1  
Preliminaries

**CONSTRUCTION OF NEW MATLALA TRADITIONAL COUNCIL OFFICE  
FOR DEPARTMENT OF COOPERATIVE GOVERNANCE HUMAN SETTLEMENTS &**

Penalty per calendar day:  
0.05% of the Contract Sum per calendar day on  
which the completion of the work may be in arrears

**SPECIAL COMPLETION REQUIREMENTS**

Not applicable

42 41.2.9 Arbitration rules as recommended by the  
Association of Arbitrators (SA)  
F:..... V:..... T:.....

Item

43 41.2.10 The law applicable to this agreement shall be  
that of  
South Africa  
F:..... V:..... T:.....

Item

**41.3 INSURANCES**

44 41.3.1 Contract work's insurance  
  
All risk and Public Liability Insurance for this  
contract shall be taken out by the Contractor in  
the joint names of the contractor and the  
employer. The cost of this insurance will be paid  
by the Contractor. Any excess in respect of a  
claim is to be paid for by the contractor  
  
..

Item

**Carried to Collection**

R

Section No. 1  
Bill No. 1  
Preliminaries

**CONSTRUCTION OF NEW MATLALA TRADITIONAL COUNCIL OFFICE  
FOR DEPARTMENT OF COOPERATIVE GOVERNANCE HUMAN SETTLEMENTS &**

45 41.3.2 Supplementary insurance:  
  
Contractor shall be responsible for the taking out his own insurances for all plant and machinery used in the execution of this contract. The cost of this insurance shall be borne by the contractor.  
  
F..... V.....  
T.....

Item

46 41.3.3 Public liability insurance to be effected by contractor  
See clause 42.3.1  
  
F:..... V:..... T:.....

Item

**41.4 DOCUMENTS**

41.4.1 Waivers of contractors lien is required **Yes**

41.4.2 Number of construction document copies to be supplied free of charge: Three

41.4.3 State other system if document is not drawn up in accordance with the Standard System of Measuring Building Work (6th Edition) (Revised) 1999

41.4.4 Number of days for submission of priced documents:  
7 working days

Notwithstanding the provisions of Clause 41.4.4, no payments will be certified unless the priced document are agreed with the Quantity surveyors.

41.4.5 JBCC N/S Subcontract Agreement are to be included in the documents: **No**

**Carried to Collection**

R

Section No. 1  
Bill No. 1  
Preliminaries

**CONSTRUCTION OF NEW MATLALA TRADITIONAL COUNCIL OFFICE FOR DEPARTMENT OF COOPERATIVE GOVERNANCE HUMAN SETTLEMENTS &**

41.4.6 Alternative if contract value is not adjusted using CPAP:

Prices and rates shall remain firm and fixed, there shall be no adjustment of the tender amounts

41.4.7 Details of changes made to the provision of JBCC standard documentation:

Payment will be made 21 days after issue of a payment certificate.

The Contractor shall issue a Tax Invoice immediately to enable the Employer to process payment. For accounting purposes, the Employer's VAT number as required by current legislation on the Tax invoice is **to be advised**

**SECTION B: PRELIMINARIES**

**Definition and interpretation (B1)**

47 Definition and interpretation (B1.1 - B1.6.5)

F:..... V:..... T:.....

Item

**Documents (B2)**

48 Checking of documents (B2.1)

F:..... V:..... T:.....

Item

49 These bills of quantities contain pages and annexures as indexed on the flyleaf

The items in these bills of quantities are to be read and priced in conjunction with and the descriptions regarded as amplified by the Model Preambles for Trades as recommended and published by the Association of South African Quantity Surveyors, 1997 edition, and no claim arising from brevity of description of items fully described in the said Model Preambles for Trades will be entertained

Item

**Carried to Collection**

R

Section No. 1  
Bill No. 1  
Preliminaries

**CONSTRUCTION OF NEW MATLALA TRADITIONAL COUNCIL OFFICE  
FOR DEPARTMENT OF COOPERATIVE GOVERNANCE HUMAN SETTLEMENTS &**

50	Provisional bills of quantities (B2.2) F:..... V:..... T:.....	N/A	
51	Availability of construction documentation for contracts based on provisional bills of quantities (B2.3) F:..... V:..... T:.....	Item	
52	Interests of agents (B2.4) F:..... V:..... T:.....	Item	
53	Priced documents (B2.5) F:..... V:..... T:.....	Item	
54	Tender submission (B2.6) F:..... V:..... T:.....	Item	
55	Notwithstanding anything contained in this clause tenders shall be valid for a period of 45 days from the closing date of tenders F:..... V:..... T:.....	Item	
	<b><u>The site (B3)</u></b>		
56	Defined works area (B3.1) F:..... V:..... T:.....	Item	
57	The area of the works to be occupied by the contractor, any restriction on the area and the limit of access or exit will be pointed out to the contractor by the principal agent at the official site briefing meeting.	Item	
58	Geotechnical investigation (B3.2) Geotechnical information will be made available to the successful bidder at the site handover meeting F:..... V:..... T:.....	Item	
	<b>Carried to Collection</b>		R
	Section No. 1 Bill No. 1 Preliminaries <b>CONSTRUCTION OF NEW MATLALA TRADITIONAL COUNCIL OFFICE FOR DEPARTMENT OF COOPERATIVE GOVERNANCE HUMAN SETTLEMENTS &amp;</b>		



59	<p>Inspection of the site (B3.3)</p> <p>It remains the responsibility of the bidder to visit the project site on his / her own to check and acquaint themselves with the site and its conditions before submitting a tender as no claims will be entertained later.</p>	Item
60	<p>No claims for extras arising from the contractor having failed to comply with this clause will be entertained</p> <p>F:..... V:..... T:.....</p>	Item
61	<p>Existing premises occupied (B3.4)</p> <p>F:..... V:..... T:.....</p>	Item
62	<p>Previous work - dimensional accuracy (B3.5)</p> <p>F:..... V:..... T:.....</p>	Item
63	<p>Previous work - defects (B3.6)</p> <p>F:..... V:..... T:.....</p>	Item
64	<p>Services - known (B3.7)</p> <p>F:..... V:..... T:.....</p>	Item
65	<p>Services - unknown (B3.8)</p> <p>F:..... V:..... T:.....</p>	Item
66	<p>Protection of trees etc (B3.9)</p> <p>F:..... V:..... T:.....</p>	Item
67	<p>Articles of value (B3.10)</p> <p>F:..... V:..... T:.....</p>	Item

**Carried to Collection**

R

Section No. 1  
 Bill No. 1  
 Preliminaries

**CONSTRUCTION OF NEW MATLALA TRADITIONAL COUNCIL OFFICE  
 FOR DEPARTMENT OF COOPERATIVE GOVERNANCE HUMAN SETTLEMENTS &**

68	Inspection of adjoining properties etc (B3.11) F:..... V:..... T:.....	Item	
<b><u>Management of contract (B4)</u></b>			
69	Management of the works (B4.1) F: ..... V: ..... T: .....	Item	
70	Progress meetings (B4.3) F:..... V:..... T:.....	Item	
71	Technical meetings (B4.4) F:..... V:..... T:.....	Item	
<b><u>Samples and shop drawings and manufacturer's instructions (B5)</u></b>			
72	Samples of materials (B5.1) F:..... V:..... T:.....	Item	
73	Workmanship samples (B5.2) F:..... V:..... T:.....	Item	
74	Shop drawings (B5.3) F:..... V:..... T:.....	Item	
<b><u>Temporary works and plant (B6)</u></b>			
75	Deposits and fees (B6.1) F:..... V:..... T:.....	Item	
76	Enclosure of the works (B6.2) F:..... V:..... T:.....	Item	
<b>Carried to Collection</b>			R
Section No. 1 Bill No. 1 Preliminaries <b>CONSTRUCTION OF NEW MATLALA TRADITIONAL COUNCIL OFFICE                  FOR DEPARTMENT OF COOPERATIVE GOVERNANCE HUMAN SETTLEMENTS &amp;</b>			

77	Advertising (B6.3) F:..... V:..... T:.....	Item
78	Plant, equipment, sheds and offices (B6.4) F:..... V:..... T:.....	Item
79	Main notice board (B6.5) F:..... V:..... T:.....	Item
80	Subcontractors notice board (B6.6) F:..... V:..... T:.....	Item
<b><u>Temporary services (B7)</u></b>		
81	Location (B7.1) F:..... V:..... T:.....	Item
82	Water (B7.2) F:..... V:..... T:.....	Item
83	Electricity (B7.3) F:..... V:..... T:.....	Item
84	Telecommunication equipment (B7.4) F:..... V:..... T:.....	Item
85	Ablution facilities (B7.5) F:..... V:..... T:.....	Item
<b><u>Prime cost amounts (B8)</u></b>		
86	Responsibility for prime cost amounts (B8.1) F:..... V:..... T:.....	Item

Carried to Collection

R

Section No. 1  
Bill No. 1  
Preliminaries

**CONSTRUCTION OF NEW MATLALA TRADITIONAL COUNCIL OFFICE  
FOR DEPARTMENT OF COOPERATIVE GOVERNANCE HUMAN SETTLEMENTS &**

**Attendance on N/S Subcontractors (B9)**

87	General attendance (B9.1) F:..... V:..... T:.....	Item
88	Special attendance (B9.2) F:..... V:..... T:.....	Item
89	Commissioning - Fuel, water and power (B9.3) F:..... V:..... T:.....	Item

**Financial aspects (B10)**

	Statutory taxes, duties and levies (B10.1) F:..... V:..... T:.....	Item
90	Provision for Value Added Tax (VAT) is made in the Final Summary. F:..... V:..... T:.....	Item
91	Payment of preliminaries (B10.2) F:..... V:..... T:.....	Item
92	Adjustment of preliminaries (B10.3) F:..... V:..... T:.....	Item
93	Payment certificate cash flow (B10.4) F:..... V:..... T:.....	Item
94	Contractor information supply (B10.5) F:..... V:..... T:.....	Item

**General (B11)**

95	Protection of works (B11.1) F:..... V:..... T:.....	Item
----	--	------

**Carried to Collection**

R

Section No. 1  
Bill No. 1  
Preliminaries

**CONSTRUCTION OF NEW MATLALA TRADITIONAL COUNCIL OFFICE  
FOR DEPARTMENT OF COOPERATIVE GOVERNANCE HUMAN SETTLEMENTS &**

96	Protection/isolation of existing/sectionally occupied works (B11.2) F:..... V:..... T:.....	Item	
97	Site security (B11.3) F:..... V:..... T:.....	Item	
98	Notice before covering work (B11.4) F:..... V:..... T:.....	Item	
99	Disturbance (B11.5) F:..... V:..... T:.....	Item	
100	Works cleaning and clearing (B11.6) F:..... V:..... T:.....	Item	
101	Vermin (B11.7) F:..... V:..... T:.....	Item	
102	Overhand work (B11.8) F:..... V:..... T:.....	Item	
<b><u>Schedule of variables (B12)</u></b>			
103	Pre-tender information (B12.1) F:..... V:..... T:.....	Item	
<p>Information necessary for elections and completion of those clauses contained in the schedule which are necessary for tender purposes is given hereunder. Where no information is given it shall mean that either no details or specific requirements are available or that the clause is not relevant to this specific contract</p>			
<b>Carried to Collection</b>			R
<p>Section No. 1            Bill No. 1            Preliminaries  <b>CONSTRUCTION OF NEW MATLALA TRADITIONAL COUNCIL OFFICE FOR DEPARTMENT OF COOPERATIVE GOVERNANCE HUMAN SETTLEMENTS &amp;</b></p>			

<p>12.1.1 Provisional bills of quantities (B2.2) The quantities are provisional:</p>	<p>No</p>		
<p>12.1.2 Availability of construction documentation (B2.3) Construction documentation is complete</p>	<p>Yes</p>		
<p>12.1.3 Interest of agents (B2.4) N/A</p>			
<p>12.1.4 Defined works area (B3.1)  See site information</p>			
<p>12.1.5 Geotechnical investigation (B3.2)  To obtain from the Project Architect  Geotechnical information will be made available to the successful bidder at the site handover meeting</p>			
<p>12.1.6 Existing premises occupied (B3.4)</p>			
<p>12.1.7 Services - known (B3.7)  Existing services and points of connection will be pointed out to the successful contractor by the principal agent</p>			
<p>12.1.8 Protection of trees (B3.9)</p>			
<p>12.1.9 Inspection of adjoining properties (B3.11)</p>			
<p>12.1.10 Enclosure of the works (B6.2)</p>			
<p><b>Carried to Collection</b></p>			<p>R</p>
<p>Section No. 1 Bill No. 1 Preliminaries <b>CONSTRUCTION OF NEW MATLALA TRADITIONAL COUNCIL OFFICE FOR DEPARTMENT OF COOPERATIVE GOVERNANCE HUMAN SETTLEMENTS &amp;</b></p>			

12.1.11 Offices (B6.4.3)

The contractor shall provide, maintain and remove on completion of the work an office for the exclusive use of the SEO minimum size 4 x 6 x 3m high internally, suitably insulated and ventilated, provided with electric lighting and fitted with boarded floor, desk, chair, drawing chair, drawing board and lockup drawer for drawings. The office shall be kept clean and fit for use at all times

12.1.12 Main notice board (B6.5)

The contractor shall provide, erect where directed, maintain and remove on completion of the works a notice board size 3 x 3m, all constructed of suitable boarding with flat smooth surface and with edging bead 19mm thick all round outer edges and projecting 12mm from face of boarding and rounded on front edge. The board shall be securely fixed to hoarding, where hoarding is provided, or fixed to and including a suitable supporting structure of timber or tubular posts and braces. The board is to be painted ivory white and the bead and 12mm wide dividing lines, deep blue. All wording shall be inscribed in deep blue painted "sans serif" lettering

12.1.13 Subcontractors notice board (B6.6)

A notice board is required

**No**

12.1.14 Water (B7.2)

Contractor to provide

12.1.15 Electricity (B7.3)

Contractor to provide

12.1.16 Telecommunications (B7.4)

Contractor to provide

12.1.17 Ablution facilities (B7.5)

Contractor to provide

**Carried to Collection**

R

Section No. 1  
 Bill No. 1  
 Preliminaries

**CONSTRUCTION OF NEW MATLALA TRADITIONAL COUNCIL OFFICE  
 FOR DEPARTMENT OF COOPERATIVE GOVERNANCE HUMAN SETTLEMENTS &**

	<p>12.1.18 Special attendance (B9.2)</p> <p>12.1.19 Protection of the works (B11.1)</p> <p>12.1.20 Protection of existing/sectionally occupied works (B11.2) Protection is required <b>Yes</b></p> <p>12.1.21 Disturbance (B11.5)</p> <p>The contractor's attention is drawn to the fact that certain portions of the Works will be constructed in the vicinity of built up areas, The contractor shall exercise all necessary precautions to ensure the safety and convenience of the public.</p>			
<p>104</p>	<p>Post tender information (B12.2)</p> <p>F:..... V:..... T:.....</p> <p>12.2.1 Payment of preliminaries Alternative selected: (B)</p> <p>12.2.2 Adjustment of preliminaries Alternative selected: (A)</p> <p>12.2.3 Additional agreed preliminaries item N/A</p>	<p>Item</p>		
<p>105</p>	<p><b><u>SECTION C: SPECIFIC PRELIMINARIES</u></b></p> <p><b>PROPRIETARY BRANDED PRODUCTS</b></p> <p>The contractor shall take delivery of, handle, store, use apply and/or fix all proprietary branded products in strict accordance with the manufacturers' instruction after consultation with the manufacturer's authorized representative</p> <p>F:..... V:..... T:.....</p>	<p>Item</p>		
	<p style="text-align: center;"><b>Carried to Collection</b></p> <p>Section No. 1 Bill No. 1 Preliminaries</p> <p><b>CONSTRUCTION OF NEW MATLALA TRADITIONAL COUNCIL OFFICE FOR DEPARTMENT OF COOPERATIVE GOVERNANCE HUMAN SETTLEMENTS &amp;</b></p>		<p>R</p>	



<p>106</p>	<p><b>OVERTIME</b></p> <p>Should overtime be required to be worked for any reason whatsoever, the costs of such overtime are to be borne by the contractor unless the principal agent has specifically authorized in writing, prior to the execution thereof, that costs for such overtime are to be borne by the employer.</p> <p>F:..... V:..... T:.....</p>	<p>Item</p>		
<p>107</p>	<p><b>AS BUILT DRAWINGS</b></p> <p>The position of construction breaks and the extent of individual concrete pours are to be recorded by the contractor on the structural engineer's drawings and are to be submitted to the principal agent and the structural engineer for their records.</p> <p>F:..... V:..... T:.....</p>	<p>Item</p>		
<p>108</p>	<p><b>SITE INSTRUCTIONS</b></p> <p>Site instructions issued on site are to be recorded in triplicate in a site instruction book which is to be maintained on site by the contractor</p> <p>F:..... V:..... T:.....</p>	<p>Item</p>		
<p>109</p>	<p><b>LABOUR RECORD</b></p> <p>At the end of each week the contractor shall provide the principal agent with a written record, in schedule form, reflecting the number and description of tradesmen and labourers employed by him and all subcontractors on the works each day.</p> <p>F:..... V:..... T:.....</p>	<p>Item</p>		
<p>110</p>	<p><b>PLANT RECORD</b></p> <p>At the end of each week the contractor shall provide the principal agent with a written record, in schedule form, reflecting the number, type and capacity of all plant, excluding hand tools, currently used on the works.</p> <p>F:..... V:..... T:.....</p>	<p>Item</p>		
<p><b>Carried to Collection</b></p>				
<p>Section No. 1                  Bill No. 1                  Preliminaries  <b>CONSTRUCTION OF NEW MATLALA TRADITIONAL COUNCIL OFFICE                  FOR DEPARTMENT OF COOPERATIVE GOVERNANCE HUMAN SETTLEMENTS &amp;</b></p>				

R

<p>111</p>	<p><b>NON CESSION OF MONIES</b></p> <p>The contractor shall not cede nor assign his rights or claims to any monies due or to become due under this contract</p> <p>F:..... V:..... T:.....</p>	<p>Item</p>	
<p>112</p>	<p><b>BLACK ECONOMIC EMPOWERMENT</b></p> <p>The contractor shall study and acquaint himself with the guidelines of the Black Economic Empowerment Act, and demonstrate his compliance with the requirements of the Act.</p> <p>F:..... V:..... T:.....</p>	<p>Item</p>	
<p>113</p>	<p><b>LOCAL LABOUR</b></p> <p>The contractor shall make use of local labour. It is desirable by the Employer that all unskilled labour be recruited from the local areas of the vicinity of the Works. The contractor will demonstrate his effort to fulfill compliance with this requirement</p> <p>F:..... V:..... T:.....</p>	<p>Item</p>	
<p>114</p>	<p><b>LABOUR DESK</b></p> <p>The contractor shall establish a labour desk on site with a dedicated office of maximum 9m2 with and including a desk, 2 chairs and electricity. From the labour desk, the contractor will appoint a dedicated community liaison officer. The community liaison officer will be employed by and will report to the contractor, who will in turn forward such reports to the Principal Agent.</p> <p>F:..... V:..... T:.....</p>	<p>Item</p>	
<p>115</p>	<p><b>SITE ACCOMMODATION.</b></p> <p>Provide 2 office facilities for Principal Agent Representative and one for Resident Clerk of Works ( to include desk, 2chairs and Electricity per office) Provide meeting Facility to accommodate 12 chairs Provide Ablution facilities for the above</p> <p>F:..... V:..... T:.....</p>	<p>Item</p>	
<p><b>Carried to Collection</b></p>			<p>R</p>
<p>Section No. 1 Bill No. 1 Preliminaries <b>CONSTRUCTION OF NEW MATLALA TRADITIONAL COUNCIL OFFICE FOR DEPARTMENT OF COOPERATIVE GOVERNANCE HUMAN SETTLEMENTS &amp;</b></p>			

116	HEALTH AND SAFETY ACT (Act 85 of 1993)  Compliance with the Occupational Health and Safety Act (Act 85 of 1993) and all relevant and applicable regulations, especially the Construction Health & Safety Act (Act 85 of 1993) (as amended) for the duration of the contract		Item	
117	Provisions of OH&S Plan prior to commencement of works as well as a full consolidated copy of such plan at the completion of construction work inclusive of a record of all drawings, designs, copies of statutory appointments, material used and other similar information concerning completed contract		Item	
118	Implementation of approved OHS Plan for duration of contract, including daily/weekly inspections, monthly meetings, required audits, consolidated health and safety file, etc		Item	
119	Registration with Compensation Fund or approved /licensed compensation insurer		Item	
120	Full time competent employee of the Contractor as safety construction supervisor and assistant safety construction supervisors for duration of contract		Item	
121	Health and safety training and induction requirements of all persons entering the site		Item	
122	HIV AND AIDS POLICY  Observation of all legislation, policies and by-laws regulating the "AIDS" endemic and "HIV" prevention, treatment and observation		Item	
	<b><u>Provision of Training Allowance in terms of EPWP prescripts</u></b>			
123	Training allowance paid to targeted labour in terms of formal training days	PDT		
124	Extra over for the administration payment of training allowances to targeted labour (25% of training allowance)		Item	
	<b>Carried to Collection</b>			R
	Section No. 1 Bill No. 1 Preliminaries			
	<b>CONSTRUCTION OF NEW MATLALA TRADITIONAL COUNCIL OFFICE FOR DEPARTMENT OF COOPERATIVE GOVERNANCE HUMAN SETTLEMENTS &amp;</b>			

125 Transport and accommodation of workers for training where it is not possible to undertake the training in close proximity to the site (Provisional Sum)

Item

**BILL NO. 2**

**COVID-19 HEALTH & SAFETY COMPLIANCE**

**PREAMBLES**

All prices/rates to be net, excluding Value Added Tax

**SUPPLEMENTARY PREAMBLES**

**Disaster Management Act: Regulations: Alert during Corona virus COVID-19 lock down**

- i) The following is an extraction from the original gazetted Alert regulations. Amendments as gazetted in Gazette are indicated as follows - changes. Amendments as gazetted as follows - changes as detailed in the website indicated hereunder <https://www.gov.za/Coronavirus>

**Surgical Mask - Patient**

**Mask, face, aseptic: Fluid Resistant, Moulded, Blue (3 PLY), good breathability, internal and external faces should be clearly identified Type I, with ear loops or tie on**

WHO standards / description

- 126
- EN 14683 any type including Type I
  - ASTM F2100 minimum level 1 or equivalent  
= (Box of 50 pieces) price per mask

No

50

**Surgical Mask - Health Care Worker**

**Mask, face, aseptic: Fluid Resistant, Molded, Blue (3 PLY), good breathability, internal and external faces should be clearly identified Type II or higher, with ear loops or tie on**

Carried to Collection

R

Section No. 1  
Bill No. 1  
Preliminaries

**CONSTRUCTION OF NEW MATLALA TRADITIONAL COUNCIL OFFICE  
FOR DEPARTMENT OF COOPERATIVE GOVERNANCE HUMAN SETTLEMENTS &**

	<u>WHO standards / description</u>			
127	<ul style="list-style-type: none"> <li>• EU MDD Directive 93/42/EEC Category III or equivalent</li> <li>• EN 14683 Type II, IR, IIR</li> <li>• ASTM F2100 minimum level 1 or equivalent <b>(Only Health departments may procure this item)</b></li> </ul> <p>= (Box of 50 pieces) price per mask</p>	No	50	
<b>Carried to Collection</b>				R
Section No. 1 Bill No. 1 Preliminaries <b>CONSTRUCTION OF NEW MATLALA TRADITIONAL COUNCIL OFFICE            FOR DEPARTMENT OF COOPERATIVE GOVERNANCE HUMAN SETTLEMENTS &amp;</b>				

<p>128</p>	<p><b><u>Mask Respirator</u></b></p> <p><b><u>N95 or FFP2 - Mask Respirator / Dust Mask, or higher. Good breathability with design that does not collapse against the mouth (e.g. duckbill, cup-shaped)</u></b></p> <p><u>WHO standards / description</u></p> <ul style="list-style-type: none"> <li>• Minimum "N95" respirator according to FDA Class II, under 21 CFR 878.4040, and CDC NIOSH, or</li> <li>• Minimum "FFP2 according to EN 149, EU PPE</li> <li>• Regulation 2016/425 Category III, or equivalent = (Box of 10 pieces) price per mask</li> </ul>	<p>No</p> <p>10</p>	
<p>129</p>	<p><b><u>Apron</u></b></p> <p><b><u>Straight apron with bib, Fabric: 100% polyester with PVC coating, or 100% PVC, or 100% rubber, or other fluid resistant coated material.</u></b></p> <p><b><u>Waterproof, sewn strap for neck and back fastening. Minimum basis weight: 300 g/m2, Covering size: 70 - 90 cm (width) x 120 - 150 cm (height). Reusable (provided appropriate arrangements for decontamination are in place)</u></b></p> <p><u>WHO standards / description</u></p> <ul style="list-style-type: none"> <li>• EN ISO 13688</li> <li>• EN 14126-B and partial protection (EN 13034 or EN 14605)</li> <li>• EN 343 for water and breathability or equivalent = (Box of 100 pieces) price per apron</li> </ul>	<p>No</p> <p>100</p>	
<p><b>Carried to Collection</b></p>			<p>R</p>
<p>Section No. 1 Bill No. 1 Preliminaries <b>CONSTRUCTION OF NEW MATLALA TRADITIONAL COUNCIL OFFICE FOR DEPARTMENT OF COOPERATIVE GOVERNANCE HUMAN SETTLEMENTS &amp;</b></p>			

**Eye Protection**

**Goggles**

**Good seal with the skin of the face, flexible PVC frame to easily fit with all face contours with even pressure, enclose eyes and the surrounding areas, accommodate wearers with prescription glasses, clear plastic lens with fog and scratch resistant treatments, adjustable band to secure firmly so as not to become loose during clinical activity, indirect venting to avoid fogging. May be re-usable (provided appropriate arrangements for decontamination are in place) or disposable.**

WHO standards / description

- 130
- EU PPE Regulation 2016/425
  - EN 166
  - ANSI/ISEA Z87.1 or equivalent  
= Each

No 70

**Visor / Face Shield**

**Made of clear plastic and providing good visibility to both the wearer and the patient. Adjustable band to attach firmly around the head and fit snugly against the forehead, fog resistant (preferable). Completely cover the sides and length of the face. May be reusable (made of robust material which can be cleaned and disinfected) or disposable.**

WHO standards / description

- 131
- EU PPE Regulation 2016/425
  - EN 166
  - ANSI/ISEA Z87.1 or equivalent  
= Each

No 70

**Gowns**

Carried to Collection

R

Section No. 1  
Bill No. 1  
Preliminaries

**CONSTRUCTION OF NEW MATLALA TRADITIONAL COUNCIL OFFICE  
FOR DEPARTMENT OF COOPERATIVE GOVERNANCE HUMAN SETTLEMENTS &**

	<p><b><u>Isolation gown</u></b>  <b><u>Protective 3- layers of spunbond meltblown spunbound fabric (Top layer of spunbound polypropylene, a middle layer of meltdown polypropylene and a bottom layer of meltdown polypropylene for light fluid contact and contact Isolation, elastic cuff, Tape-tab neck closure, Tie waist, Non Sterile Dimensions: Large Length: (from shoulder to hem) 116cm Sleeve length: (from shoulder to wrist) 56cm Belt length: 167cm; Belt Width: 5cm; Belt place: (neck to top of belt) 38cm</u></b></p>			
132	<p><u>WHO standards / description</u></p> <ul style="list-style-type: none"> <li>• EU PPE Regulation 2016/425 and EU MDD Directive 93/42/EEC</li> <li>• FDA Class I or II medical device, or equivalent</li> <li>• EN 13795 any performance level, or</li> <li>• AAMI PB70 all levels acceptable, or equivalent</li> </ul> <p>= Each</p>	No	4	
	<p><b><u>Gown, surgical, non-woven polypropylene body+-54g/m sleeves +- 66g/m. Long sleeves with cuffs. Reinforced in chest and forearm areas. Resistant to liquid penetration. Lint free, non flammable, Bacteria barrier efficiency, to comply with SANS 53795, Compliance certificate to be submitted, Sterile, individual double peel packed</u></b></p>			
133	<p><u>WHO standards / description</u></p> <ul style="list-style-type: none"> <li>• EU PPE Regulation 2016/425 and EU MDD Directive 93/42/EEC</li> <li>• FDA Class I or II medical device, or equivalent</li> <li>• EN 13795 any performance level, or</li> <li>• AAMI PB70 all levels acceptable, or equivalent</li> </ul> <p><b><i>(Only Health departments may procure this item)</i></b></p> <p>= Each</p>	No	4	
	<p><b><u>Coveralls</u></b></p> <p><b><u>Protective cover bodysuits, disposable MEDIUM, LARGE, X-LARGE, XX-LARGE, 3X LARGE</u></b></p>			
	<p style="text-align: center;"><b>Carried to Collection</b></p> <p>Section No. 1          Bill No. 1          Preliminaries</p> <p><b>CONSTRUCTION OF NEW MATLALA TRADITIONAL COUNCIL OFFICE FOR DEPARTMENT OF COOPERATIVE GOVERNANCE HUMAN SETTLEMENTS &amp;</b></p>			R



	<u>WHO standards / description</u>			
134	Tunic/tops, woven, scrubs, reusable or single use, short sleeved (tunic/tops), worn underneath the coveralls or gown. Trouser/pants, woven, scrubs, reusable or single use, worn underneath the coveralls or gown = Each per coveralls	No	4	
135	<ul style="list-style-type: none"> <li>• EU PPE Regulation 2016/425</li> <li>• EN 166</li> <li>• ANSI/ISEA Z87.1 or equivalent</li> </ul> = Each	No	140	
	<b><u>Provision for Personal Protective Equipment &amp; Protective Clothing:</u></b>			
136	vii) Face Mask for COVID-19 (respiratory protection (as required) for approximately 70 people x 24 months	No	1 680	
137	viii) Surgical Gloves (for security and cleaning team) weekly for approximately 70 people x 24 months	No	70	
	<b><u>Costs of medical certificate and Medical Surveillance</u></b>			
	<b><u>Examination Gloves, non-sterile</u></b>			
	<b><u>Gloves, examination, nitrile, powder-free, non-sterile, single-useGloves should have long cuffs, reaching well above the wrist, ideally to mid-forearm.Sizes: small, medium, large.</u></b>			
	<u>WHO standards / description</u>			
138	<ul style="list-style-type: none"> <li>• EU MDD Directive 93/42/EEC Category III</li> <li>• EU PPE Regulation 2016/425 Category III</li> <li>• EN 455</li> <li>• EN 374</li> <li>• ANSI/ISEA 105,</li> <li>• ASTM D6319,or equivalent</li> </ul> = Box of 100 pieces/ per single glove	No	2	
	<b>Carried to Collection</b>			R
	Section No. 1 Bill No. 1 Preliminaries			
	<b>CONSTRUCTION OF NEW MATLALA TRADITIONAL COUNCIL OFFICE FOR DEPARTMENT OF COOPERATIVE GOVERNANCE HUMAN SETTLEMENTS &amp;</b>			

**Gloves, examination or surgical, sterile**

**Gloves - surgical or examination - nitrile, powder free, sterile, single-use. Gloves should have long cuffs, reaching well above the wrist, ideally to midforearm.Sizes: small, medium, large.**

WHO standards / description

139	<ul style="list-style-type: none"> <li>• EU MDD Directive 93/42/EEC Category III,</li> <li>• EU PPE Regulation 2016/425 Category III,</li> <li>• EN 455,</li> <li>• ANSI/ISEA 105,</li> <li>• ASTM D6319or equivalent</li> </ul> (Only Health departments may procure this item} = Box of 100 pieces/ per single glove	No	2
-----	---	----	---

140	ii) Exit examinations	No	2
-----	-----------------------	----	---

141	Re- Induction Training for COVID-19		Item
-----	-------------------------------------	--	------

**Digital Thermometer**

142	Digital Body Thermometer INFRARED NON CONTACT	No	4
-----	---	----	---

**Sanitisers and Disinfectants**

143	Sanitizer, with not less than 70% alcohol must comply to WHO-recommended handrub formulations	I	100
-----	---	---	-----

Carried to Collection

R

Section No. 1  
 Bill No. 1  
 Preliminaries

**CONSTRUCTION OF NEW MATLALA TRADITIONAL COUNCIL OFFICE  
 FOR DEPARTMENT OF COOPERATIVE GOVERNANCE HUMAN SETTLEMENTS &**

**Bio-Hazard bags**

**Bright red colour PP bags are easy to open and are used to dispose used Micro tips, Tubes and other plastic products.**

144	Disposal bag for bio-hazardous waste, 30 x 50cm, with "Bio Hazard" print, autoclavable polypropylene. 50 or 70 micron thickness	No	2
-----	---	----	---

**Fixed-Charge items**

145	Contractual requirements		Item
146	Other fixed-charge obligations for COVID-19 Hand Sanitiser - 500ml	No	50
147	Cleaning and detergents for cleaning everyday	No	390
148	Daily Logbook for above	No	5
149	Waste management for COVID-19 Waste Bins		Item
150	Transport to Construction Site		Item

**Safety for COVID-19**

Maintenance of a register for workers contacts

151	Removal of Site establishment on completion		Item
152	Contractual requirements		Item

**Carried to Collection**

R

Section No. 1  
Bill No. 1  
Preliminaries

**CONSTRUCTION OF NEW MATLALA TRADITIONAL COUNCIL OFFICE  
FOR DEPARTMENT OF COOPERATIVE GOVERNANCE HUMAN SETTLEMENTS &**

Section No. 1

Bill No. 1

Preliminaries

**COLLECTION**

Total Brought Forward from Page No.

**Page  
No**

**Amount**

- 1
- 2
- 3
- 4
- 5
- 6
- 7
- 8
- 9
- 10
- 11
- 12
- 13
- 14
- 15
- 16
- 17
- 18
- 19
- 20

**Carried Forward**

R

Section No. 1

Bill No. 1

Preliminaries

**CONSTRUCTION OF NEW MATLALA TRADITIONAL COUNCIL OFFICE  
FOR DEPARTMENT OF COOPERATIVE GOVERNANCE HUMAN SETTLEMENTS &**

Section No. 1

Bill No. 1

Preliminaries

**COLLECTION**

**Page  
No**

**Amount**

**Brought Forward**

R

Total Brought Forward from Page No.

21

22

23

24

25

26

27

28

29

30

31

32

**Carried to Final Summary**

R

Section No. 1

Bill No. 1

Preliminaries

**CONSTRUCTION OF NEW MATLALA TRADITIONAL COUNCIL OFFICE  
FOR DEPARTMENT OF COOPERATIVE GOVERNANCE HUMAN SETTLEMENTS &**

Item No		Quantity	Rate	Amount
	<b><u>SECTION No. 2BILL No. 1</u></b>			
	<b><u>EARTHWORKS (PROVISIONAL)</u></b>			
	<b><u>PREAMBLES</u></b>			
	For Preambles see "Model Preambles For Trades"			
	<b><u>EXCAVATION, FILLING, ETC OTHER THAN BULK</u></b>			
	<b><u>Excavation in earth not exceeding 2m deep</u></b>			
1	Trenches	m3	232	
2	Holes	m3	2	
	<b><u>Extra over bulk excavation in earth for excavation in</u></b>			
3	Soft rock	m3	23	
4	Hard rock	m3	23	
	<b><u>Extra over all excavations for carting away</u></b>			
5	Surplus material from excavations and/or stock piles on site to a dumping site to be located by the contractor	m3	109	
	<b><u>Risk of collapse of excavations</u></b>			
6	Sides of excavations not exceeding 1,5m deep	m2	712	
	<b><u>Keeping excavations free of water</u></b>			
7	Keeping excavations free of water		Item	
	<b><u>Earth filling obtained from the excavations and/or prescribed stock piles on site compacted to 93% Mod AASHTO density</u></b>			
8	As backfilling to foundations	m3	123	
9	Under floors, steps, pavings, etc	m3	109	
	<b>Carried to Collection</b>			R
	Section No. 2			
	Bill No. 1			
	Earthworks (Provisional)			
	<b>CONSTRUCTION OF NEW MATLALA TRADITIONAL COUNCIL OFFICE</b>			
	<b>FOR DEPARTMENT OF COOPERATIVE GOVERNANCE HUMAN SETTLEMENTS &amp;</b>			

<b><u>Earth filling supplied by the contractor compacted to 93% Mod AASHTO density</u></b>				
10	Under floors, steps, pavings, etc	m3	159	
<b><u>Compaction of surfaces</u></b>				
11	Compaction of ground surface under floors etc including scarifying for a depth of 100mm, breaking down oversize material, adding suitable material where necessary and compacting to 93% Mod AASHTO density	m2	623	
<b><u>Prescribed density tests on filling</u></b>				
12	"Modified AASHTO Density" test	No	10	
<b><u>PROTECTION AGAINST TERMITES</u></b>				
<b><u>Soil insecticide</u></b>				
13	Poisoning surface of ground in bottoms of trenches, bases, etc	m2	943	
14	Poisoning surface of ground or filling under floors, steps, etc. including raking out 75mm deep V-shaped channels against the walls, etc., treated with poison solution, backfilling and ramming	m2	623	
<b>Carried to Collection</b>				
Section No. 2				
Bill No. 1				
Earthworks (Provisional)				
<b>CONSTRUCTION OF NEW MATLALA TRADITIONAL COUNCIL OFFICE FOR DEPARTMENT OF COOPERATIVE GOVERNANCE HUMAN SETTLEMENTS &amp;</b>				

R

Section No. 2

Bill No. 1

Earthworks (Provisional)

**COLLECTION**

Total Brought Forward from Page No.

**Page  
No**

**Amount**

35

36

**Carried Forward to Summary of Section No. 2**

R

Section No. 2

Bill No. 1

Earthworks (Provisional)

**CONSTRUCTION OF NEW MATLALA TRADITIONAL COUNCIL OFFICE  
FOR DEPARTMENT OF COOPERATIVE GOVERNANCE HUMAN SETTLEMENTS &**



Item No		Quantity	Rate	Amount
	<b><u>SECTION No. 2BILL No. 2</u></b>			
	<b><u>CONCRETE, FORMWORK AND REINFORCEMENT</u></b>			
	<b><u>PREAMBLES</u></b>			
	For Preambles see "Model Preambles For Trades"			
	<b><u>UNREINFORCED CONCRETE CAST AGAINST EXCAVATED SURFACES</u></b>			
	<b><u>15Mpa/19mm Concrete</u></b>			
1	Surface blinding under footings and bases	m3	12	
2	Apron	m3	16	
	<b><u>REINFORCED CONCRETE CAST AGAINST EXCAVATED SURFACES</u></b>			
	<b><u>30 MPa/19mm Concrete</u></b>			
3	Strip footings	m3	53	
4	Base	m3	1	
	<b><u>REINFORCED CONCRETE</u></b>			
	<b><u>30 MPa/19mm Concrete</u></b>			
5	Slab	m3	1	
6	Surface beds	m3	56	
	<b><u>25 MPa/19mm Concrete</u></b>			
7	Ring beam	m3	8	
	<b><u>TEST BLOCKS</u></b>			
8	Making and testing a set of three 150 x 150 x 150mm concrete strength test cube (Provisional)	No	18	
	<b>Carried to Collection</b>			
	Section No. 2			
	Bill No. 2			
	Concrete, Formwork & Reinforcement			
	<b>CONSTRUCTION OF NEW MATLALA TRADITIONAL COUNCIL OFFICE FOR DEPARTMENT OF COOPERATIVE GOVERNANCE HUMAN SETTLEMENTS &amp;</b>			

<b><u>Finishing top surfaces of concrete smooth with a wood float</u></b>				
9	Surface beds, slabs, etc	m2	795	
<b><u>SMOOTH FORMWORK (DEGREE OF ACCURACY II)</u></b>				
<b><u>Smooth formwork to sides</u></b>				
10	Edges, risers, ends and reveals not exceeding 300mm high or wide	m	319	
11	Edges, risers, ends and reveals, exceeding 300mm high or wide	m	14	
<b><u>Smooth formwork to soffits</u></b>				
12	Slabs propped up exceeding 1,50m and not exceeding 3,50m high	m2	11	
<b><u>REINFORCEMENT</u></b>				
<b><u>Mild steel reinforcement to structural concrete work</u></b>				
13	Steel bar reinforcement of various diameters (100kg/m3)	t	6.24	
<b><u>Fabric reinforcement</u></b>				
14	Ref 193 mesh steel reinforcement in concrete walls, etc	m2	623	
<b>Carried to Collection</b>				
Section No. 2				
Bill No. 2				
Concrete, Formwork & Reinforcement				
<b>CONSTRUCTION OF NEW MATLALA TRADITIONAL COUNCIL OFFICE</b>				
<b>FOR DEPARTMENT OF COOPERATIVE GOVERNANCE HUMAN SETTLEMENTS &amp;</b>				

R

Section No. 2

Bill No. 2

Concrete, Formwork & Reinforcement

**COLLECTION**

Total Brought Forward from Page No.

**Page  
No**

**Amount**

38

39

**Carried Forward to Summary of Section No. 2**

R

Section No. 2

Bill No. 2

Concrete, Formwork & Reinforcement

**CONSTRUCTION OF NEW MATLALA TRADITIONAL COUNCIL OFFICE  
FOR DEPARTMENT OF COOPERATIVE GOVERNANCE HUMAN SETTLEMENTS &**

Item No	Quantity	Rate	Amount
<b><u>SECTION No. 2BILL No. 3</u></b>			
<b><u>MASONRY</u></b>			
<b><u>PREAMBLES</u></b>			
For Preambles see "Model Preambles For Trades"			
<b><u>SUPPLEMENTARY PREAMBLES</u></b>			
<b><u>BRICKWORK</u></b>			
<b><u>Sizes in descriptions</u></b>			
Where sizes in descriptions are given in brick units, "one brick" shall represent the length and "half brick" the width of a brick			
<b><u>Face bricks</u></b>			
Bricks shall be ordered timeously to obtain uniformity in size and colour			
<b><u>Pointing</u></b>			
Descriptions of recessed pointing to fair face brickwork and face brickwork shall be deemed to include square recessed, hollow recessed, weathered pointing, etc			
<b><u>FOUNDATIONS</u></b>			
<b><u>Brickwork of NFXE bricks (14 MPa nominal compressive strength) in class I mortar in loadbearing walls etc</u></b>			
1	Brick piers	m3	1
2	Half brick wall	m2	105
3	One brick walls	m2	322
<b>Carried to Collection</b>			R
Section No. 2 Bill No. 3 Masonry			
<b>CONSTRUCTION OF NEW MATLALA TRADITIONAL COUNCIL OFFICE FOR DEPARTMENT OF COOPERATIVE GOVERNANCE HUMAN SETTLEMENTS &amp;</b>			

<b><u>Brickwork reinforcement</u></b>				
4	75mm Wide reinforcement built in horizontally	m	615	
5	150mm Wide reinforcement built in horizontally	m	1 876	
<b><u>SUPERSTRUCTURE</u></b>				
<b><u>Brickwork of NFXE bricks (14 MPa nominal compressive strength) in class I mortar in loadbearing walls etc</u></b>				
6	Brick piers	m3	0.3	
7	Half brick walls	m2	195	
8	Half brick wall in beamfilling	m2	41	
9	One brick walls	m2	648	
<b><u>BRICKWORK SUNDRIES</u></b>				
<b><u>Galvanised hoop iron cramps, ties, etc</u></b>				
10	30 x 1,6mm Roof tie 1,5m long with one end fixed to timber and other end built into brickwork	No	160	
<b><u>Brickwork reinforcement</u></b>				
11	75mm Wide reinforcement	m	893	
12	150mm Wide reinforcement	m	1 915	
<b><u>Prestressed precast concrete fabricated lintels</u></b>				
13	110 x 75mm Lintels in lengths exceeding 3m	m	87	
<b><u>Turning pieces to lintels etc</u></b>				
14	110mm Wide turning pieces	m	139	
<b><u>FIBRE-CEMENT WINDOW SILLS</u></b>				
<b>Carried to Collection</b>				R
Section No. 2				
Bill No. 3				
Masonry				
<b>CONSTRUCTION OF NEW MATLALA TRADITIONAL COUNCIL OFFICE</b>				
<b>FOR DEPARTMENT OF COOPERATIVE GOVERNANCE HUMAN SETTLEMENTS &amp;</b>				

	<u>Natural grey sills in single lengths bedded in class II mortar including metal fixing lugs etc</u>		
15	15 x 150mm Wide sills set flat and slightly projecting	m	62
	<u>Joint forming material in movement joints</u>		
16	12mm Fibre board built in vertically between concrete surface and brick skins	m2	4
	<b><u>FACE BRICKWORK</u></b>		
	<b><u>External facings in approved face bricks (FBS) with a PC Amount of R 5 500.00 per thousand bricks delivered to site (excluding VAT) pointed with square recessed horizontal and vertical joints</u></b>		
17	Extra over brickwork for face brickwork in foundation	m2	96
18	Extra over brickwork for external face brickwork	m2	354
19	Extra over brickwork for brick-on-edge header course lintels one course high, pointed on face and 110mm soffit	m	67
	<b><u>Brick-on-edge header course copings, sills, etc of Approved face bricks (FBS) with a PC Amount of R 3 500.00 per thousand bricks delivered to site (excluding VAT) pointed with polished recessed joints on all exposed faces</u></b>		
20	180mm Wide sill sloping and slightly projecting	m	62

Carried to Collection

R

Section No. 2  
 Bill No. 3  
 Masonry

**CONSTRUCTION OF NEW MATLALA TRADITIONAL COUNCIL OFFICE  
 FOR DEPARTMENT OF COOPERATIVE GOVERNANCE HUMAN SETTLEMENTS &**

Section No. 2

Bill No. 3

Masonry

**COLLECTION**

Total Brought Forward from Page No.

**Page  
No**

**Amount**

41

42

43

**Carried Forward to Summary of Section No. 2**

R

Section No. 2

Bill No. 3

Masonry

**CONSTRUCTION OF NEW MATLALA TRADITIONAL COUNCIL OFFICE  
FOR DEPARTMENT OF COOPERATIVE GOVERNANCE HUMAN SETTLEMENTS &**

Item No	<b><u>SECTION 2</u></b>	Quantity	Rate	Amount
	<b><u>BILL NO. 4</u></b>			
	<b><u>WATERPROOFING</u></b>			
	<b><u>PREAMBLES</u></b>			
	For Preambles see "Model Preambles For Trades"			
	<b><u>SUPPLEMENTARY PREAMBLES</u></b>			
	<b><u>Waterproofing</u></b>			
	Waterproofing of roofs, basements, etc shall be laid under a ten year guarantee. Waterproofing to roofs shall be laid to even falls to outlets etc with necessary ridges, hips and valleys. Descriptions of sheet or membrane waterproofing shall be deemed to include additional labour to turn-ups and turn-downs			
	Waterproofing to roofs shall be laid to even falls to outlets etc with necessary ridges, hips and valleys. Descriptions of sheet or membrane waterproofing shall be deemed to include additional labour to turn - ups and turn - downs			
	<b><u>DAMP-PROOFING OF WALLS AND FLOORS</u></b>			
	<b><u>One layer of 375 micron "Consol Plastics Brikgrip DPC" embossed damp proof course</u></b>			
1	In walls	m2	72	
2	In walls under cills	m2	25	
	<b><u>One layer of 250 micron "Consol plastics Gunplas black" waterproof sheeting sealed at laps " Gunplas pressure sensitive tape"</u></b>			
3	Under surface beds	m2	623	
	<b><u>WATERPROOFING TO ROOFS, BASEMENTS, ETC</u></b>			
	<b>Carried to Collection</b>			R
	Section No. 2 Bill No. 4 Waterproofing			
	<b>CONSTRUCTION OF NEW MATLALA TRADITIONAL COUNCIL OFFICE FOR DEPARTMENT OF COOPERATIVE GOVERNANCE HUMAN SETTLEMENTS &amp;</b>			



<b><u>4mm "Derbigum SP" waterproofing</u></b>				
4	To upstands, etc	m2	11	
<b><u>JOINT SEALANTS ETC</u></b>				
<b><u>Two-part grey polysulphide sealing compound including backing cord, bond breaker, primer, etc</u></b>				
5	10 x 15mm In expansion joints in floors including raking out expansion joint filler as necessary as 5/30	m	16	
<b>Carried to Collection</b>				R
Section No. 2				
Bill No. 4				
Waterproofing				
<b>CONSTRUCTION OF NEW MATLALA TRADITIONAL COUNCIL OFFICE FOR DEPARTMENT OF COOPERATIVE GOVERNANCE HUMAN SETTLEMENTS &amp;</b>				

Section No. 2

Bill No. 4

Waterproofing

**COLLECTION**

Total Brought Forward from Page No.

**Page  
No**

45

46

**Amount**

**Carried Forward to Summary of Section No. 2**

R

Section No. 2

Bill No. 4

Waterproofing

**CONSTRUCTION OF NEW MATLALA TRADITIONAL COUNCIL OFFICE  
FOR DEPARTMENT OF COOPERATIVE GOVERNANCE HUMAN SETTLEMENTS &**

Item No		Quantity	Rate	Amount
	<b><u>SECTION No. 2BILL No. 5</u></b>			
	<b><u>ROOF COVERING</u></b>			
	<b><u>PREAMBLES</u></b>			
	For Preambles see "Model Preambles For Trades"			
	<b><u>PROFILED METAL SHEETING AND ACCESSORIES</u></b>			
	<b><u>0,6mm "Brownbuilt Kliplock" steel sheet in single lengths fixed to steel rails and 900mm centres embossed galvanised sheet steel accessories</u></b>			
1	Roof covering with 25 degrees pitch	m2	776	
2	Ridge capping 550mm girth	m	69	
3	Valley cappings 550mm girth	m	18	
4	Hip capping 550mm girth	m	27	
	<b><u>SHEET METAL FLASHINGS, LININGS, COPINGS, ETC</u></b>			
	<b><u>0,6mm Galvanised sheet iron</u></b>			
5	Flashings	m2	1	
	<b><u>ROOF AND WALL INSULATION</u></b>			
	<b><u>"Sisalation 410" housing grade glass fibre reinforced aluminium foil bonded insulation</u></b>			
6	Insulation laid taut over purlins (at approximately 1,20mm centres) and fixed concurrent with roof covering including galvanised steel straining wires	m2	776	
	<b>Carried Forward to Summary of Section No. 2</b>			
	Section No. 2			
	Bill No. 5			
	Roofwork			
	<b>CONSTRUCTION OF NEW MATLALA TRADITIONAL COUNCIL OFFICE FOR DEPARTMENT OF COOPERATIVE GOVERNANCE HUMAN SETTLEMENTS &amp;</b>			
				R

Item No		Quantity	Rate	Amount
	<b><u>SECTION No. 2BILL No. 6</u></b>			
	<b><u>CARPENTRY AND JOINERY</u></b>			
	<b><u>PREAMBLES</u></b>			
	For Preambles see "Model Preambles For Trades"			
	<b><u>ROOFS ETC</u></b>			
	<b><u>Plate nailed timber roof truss construction</u></b>			
	The following is applicable in respect of roof trusses:			
	Trusses are at maximum 760mm centres			
	Roof covering is Double Roman Concrete Tiles			
	on 38 x 38mm battens on Ceilings are 4mm Fibre			
	Cement board ceiling The references given in the			
	descriptions are to the respective types of trusses			
	detailed on the architect's drawings numbered annexed			
	to these bills of quantities/accompanying these bills of			
	quantities for tender purposes			
	The dimensions in the descriptions of the trusses are			
	nominal and actual measurements are to be obtained			
	from the architect and/or the site before design or			
	fabrication commences			
	<b><u>ROOFS, ETC</u></b>			
	<b><u>Engineering Design</u></b>			
1	Allow for engineering design and certificate under the control of a registered structural Engineer in accordance with SABS 0160 AND 0163	Item		
	<b><u>Sawn softwood</u></b>			
2	38 x 114mm Wall plates	m	159	
	<b>Carried to Collection</b>			R
	Section No. 2			
	Bill No. 6			
	Carpentry			
	<b>CONSTRUCTION OF NEW MATLALA TRADITIONAL COUNCIL OFFICE</b>			
	<b>FOR DEPARTMENT OF COOPERATIVE GOVERNANCE HUMAN SETTLEMENTS &amp;</b>			

3	Roof construction to double pitched roof with three hipped ends and one valley, 14.04 x 6.96m overall on plan x 1251mm high overall, including trusses, jack rafters, permanent bracing and 50 x 76mm purlins at 1000mm centres for roof covering (wall plates elsewhere)		Item	
4	Roof construction to double pitched roof one valley ends, 14.15 x 10.19m overall on plan x 1846mm high overall, including trusses, jack rafters, permanent bracing and 50 x 76mm purlins at 1000mm centres for roof covering (wall plates elsewhere)		Item	
5	Roof construction to double pitched roof with one valley ends, 13.92 x 10.19m overall on plan x 1846mm high overall, including trusses, jack rafters, permanent bracing and 50 x 76mm purlins at 1000mm centres for roof covering (wall plates elsewhere)		Item	
6	Roof construction to double pitched roof with gable ends, 9.97 x 6.96m overall on plan x 1251mm high overall, including trusses, jack rafters, permanent bracing and 50 x 76mm purlins at 1000mm centres for roof covering (wall plates elsewhere)	No	1	
<b><u>Wrought laminated Saligna</u></b>				
7	50 x 150mm Bolted beams, pergola beams, etc	m	4	
<b><u>FACIAS, BARGE BOARDS, ETC:</u></b>				
8	12 x 225 mm Fibre cement barge board drilled and brass screwed and including steel jointing strips between lengths.	m	207	
<b><u>SKIRTINGSWrought Meranti</u></b>				
9	19 x 76mm Skirting nailed to walls with heads of nails punched and filled including 19mm quadrant bead planted on at junction with floor	m	1	
<b>Carried to Collection</b>				R
Section No. 2				
Bill No. 6				
Carpentry				
<b>CONSTRUCTION OF NEW MATLALA TRADITIONAL COUNCIL OFFICE FOR DEPARTMENT OF COOPERATIVE GOVERNANCE HUMAN SETTLEMENTS &amp;</b>				

**DOORS**

## NOTE

All framed and ledged batten doors and combination doors, where battens are utilised, shall only be of construction acceptable SABS, i.e. mortice and tenon where the tenon is exposed on the outside edges of styles and where the tenon is wedged to form a dovetailed shape

**Semi-solid core door with 3mm thick tampered Hardboard sides and concealed hardware edges**

10	44 mm Door, size 813 x 2032 mm.	No	14
----	---------------------------------	----	----

**Solid core door with 3mm thick tampered Hardboard sides and concealed hardware edges**

11	44 mm Door, size 813 x 2032 mm.	No	6
----	---------------------------------	----	---

12	44 mm Door, size 900 x 2032 mm.	No	2
----	---------------------------------	----	---

13	44 mm Double door, size 1511 x 2032mm.	No	1
----	--	----	---

**Wrought meranti doors hung to steel frames**

14	44mm Framed, ledged and braced batten door 813 x 2032mm high of 150mm wide top rail and stiles, 22 x 150mm middle ledge and braces and 22 x 220mm bottom ledge, filled in with 22mm tongued and grooved V-jointed one side vertical boarding with tongued and grooved joints to top rail and stiles and with inner edges of framing and abutting edges of boarding chamfered to form V-joint	No	6
----	--	----	---

**BUDGETARY ALLOWANCES**

15	Provide the sum of R 30 000-00 (Thirty thousand Rand) for the Sectional Overhead Sliding Double Garage Door installed complete.		Item	30 000.00
----	---	--	------	-----------

Carried to Collection

R

Section No. 2  
Bill No. 6  
Carpentry

**CONSTRUCTION OF NEW MATLALA TRADITIONAL COUNCIL OFFICE  
FOR DEPARTMENT OF COOPERATIVE GOVERNANCE HUMAN SETTLEMENTS &**

Section No. 2

Bill No. 6

Carpentry

**COLLECTION**

Total Brought Forward from Page No.

**Page  
No**

**Amount**

49

50

51

**Carried Forward to Summary of Section No. 2**

R

Section No. 2

Bill No. 6

Carpentry

**CONSTRUCTION OF NEW MATLALA TRADITIONAL COUNCIL OFFICE  
FOR DEPARTMENT OF COOPERATIVE GOVERNANCE HUMAN SETTLEMENTS &**

Item No	<b><u>SECTION No. 2BILL No. 7</u></b>	Quantity	Rate	Amount
	<b><u>CEILING, PARTITIONS AND ACCESS FLOORING</u></b>			
	<b><u>PREAMBLES</u></b>			
	For Preambles see "Model Preambles For Trades"			
	<b><u>SUPPLEMENTARY PREAMBLES</u></b>			
	<b><u>Descriptions:</u></b>			
	Items described as "nailed" shall be deemed to be fixed with hardened steel nails or pins or shot pinned to brickwork or concrete			
	Items described as "plugged" shall be deemed to include screwing to fibre, plastic or metal plugs at not exceeding 600mm centres, and where described as "bolted" the bolts have been given elsewhere			
	<b><u>CEILING ETC</u></b>			
	<b><u>NAILED UP CEILING</u></b>			
	<b><u>12,5mm "Rhino" gypsum plasterboard with taped and skimmed joints finished with one coat rhinolite plaster</u></b>			
1	Ceilings including 38 x 38mm sawn softwood bandering at 350mm centres	m2	419	
2	Extra over ceiling for opening of 650 x 650mm trap door complete with trimmers, frame,etc	No	10	
	<b><u>Cornices</u></b>			
3	50 mm Fibre cement coved cornice planted on including mitres, etc.	m	430	
	<b><u>SUSPENDED CEILING</u></b>			
	<b>Carried to Collection</b>			R
	Section No. 2 Bill No. 7 Ceilings, partitions and Access Flooring			
	<b>CONSTRUCTION OF NEW MATLALA TRADITIONAL COUNCIL OFFICE FOR DEPARTMENT OF COOPERATIVE GOVERNANCE HUMAN SETTLEMENTS &amp;</b>			



Pre-painted 600 x 1200 x 17mm "Armstrong Fine Fissured 95% RH" or equally approved acoustic panels on aluminium pre-painted exposed tee suspension system including main and cross tees, necessary hangers, grids, etc

4	Ceilings suspended not exceeding 1m below steel trusses	m2	205
---	---	----	-----

**Cornices to suspended ceilings**

5	25 x 25mm Angle profile cornice	m	103
---	---------------------------------	---	-----

**Aerolite insulation**

6	50mm Thick insulation laid on ceiling boards	m2	623
---	--	----	-----

**Carried to Collection**

R

Section No. 2

Bill No. 7

Ceilings, partitions and Access Flooring

**CONSTRUCTION OF NEW MATLALA TRADITIONAL COUNCIL OFFICE  
FOR DEPARTMENT OF COOPERATIVE GOVERNANCE HUMAN SETTLEMENTS &**

Section No. 2

Bill No. 7

Ceilings, partitions and Access Flooring

**COLLECTION**

Total Brought Forward from Page No.

**Page  
No**

53

54

**Amount**

**Carried Forward to Summary of Section No. 2**

R

Section No. 2

Bill No. 7

Ceilings, partitions and Access Flooring

**CONSTRUCTION OF NEW MATLALA TRADITIONAL COUNCIL OFFICE  
FOR DEPARTMENT OF COOPERATIVE GOVERNANCE HUMAN SETTLEMENTS &**

Item No	<u>SECTION No. 2</u>	Quantity	Rate	Amount
	<u>BILL No. 8</u>			
	<u>FLOOR COVERINGS, WALL LININGS, ETC.</u>			
	<u>PREAMBLES</u>			
	For Preambles see "Model Preambles For Trades"			
	All materials shall be in colours to be selected by the Representative/Agent and, where applicable, laid to approved patterns			
	<u>FLOOR COVERINGS</u>			
	<u>500 x 500mm "Nexus Berber Point" or equally approved carpet tiles</u>			
1	On floors	m2	1	
	<b>Carried Forward to Summary of Section No. 2</b>			R
	Section No. 2			
	Bill No. 8			
	Floor Coverings, Wall Linings, etc.			
	<b>CONSTRUCTION OF NEW MATLALA TRADITIONAL COUNCIL OFFICE FOR DEPARTMENT OF COOPERATIVE GOVERNANCE HUMAN SETTLEMENTS &amp;</b>			

Item No	Quantity	Rate	Amount
<b><u>IRONMONGERY</u></b>			
<b><u>PREAMBLES</u></b>			
For Preambles see "Model Preambles For Trades"			
<b><u>SUPPLEMENTARY PREAMBLES</u></b>			
Items, materials or methods to be used specified by trade names or catalogue numbers are only an indication of the quality required. Items, materials or methods of similar quality may be used with prior approval from the architect			
<b><u>Finishes to ironmongery</u></b>			
Where applicable finishes to ironmongery are indicated by suffixes in accordance with the following list BS Satin bronze lacquered CH Chromium plated SC Satin chromium plated SE Silver enamelled GE Grey enamelled AS Anodised silver AB Anodised bronze AG Anodised gold ABL Anodised black PB Polished brass PL Polished and lacquered PT Epoxy coated SD Sanded			
<b><u>Fixing</u></b>			
Items described as "plugged" shall be deemed to include screwing to fibre, plastic or metal plugs in brickwork or concrete			
<b><u>References</u></b>			
References in brackets at the end of descriptions refer to the Architect's schedules			
<b><u>LOCKS</u></b>			
<b><u>"Union"</u></b>			
1	Three lever double cylinder lockset code 2222 or similar with Gower Handel code CZ682-05 SC complete with striking plate fixed to metal	No	35
2	Four-lever lockset with striking plate fixed to metal	No	7
<b>Carried to Collection</b>			R
Section No. 2 Bill No. 9 Ironmongery			
<b>CONSTRUCTION OF NEW MATLALA TRADITIONAL COUNCIL OFFICE FOR DEPARTMENT OF COOPERATIVE GOVERNANCE HUMAN SETTLEMENTS &amp;</b>			

3	DMWS-SS-008 or similar Bathroom /WC small case deadlock	No	7
<b><u>LETTERS, NAMEPLATES, ETC</u></b>			
4	DSS4 'Wheelchair' or similiar pictogram on 76mm diameter stainless steel plate	No	2
5	DSS2 'Female' or similiar pictogram on 76mm diameter stainless steel plate	No	2
6	DSS1 'Male' or similiar pictogram on 76mm diameter stainless steel plate	No	3
<b><u>SUNDRIES</u></b>			
<b><u>"Dorma " or similar approved</u></b>			
7	AL87722AS Hat and coat hook with rubber tip	No	10
8	Approved Aluminuim door stop with rubber insert	No	49
9	Overhead surface mounted type door closer with aluminium casing	No	8
<b><u>"Kimberley Clark" or similar approved</u></b>			
10	Approved soap dispenser, top-up system with 800ml capacity fixed against wall in positions as shown on detail layouts and details, all as per manufactureres spec	No	7
11	Approved toilet paper dispenser fixed against wall as per manufacturers specifications	No	7
12	425792 'Kim dry' towel dispenser rail fixed against wall as per manufacturers spec	No	7

Carried to Collection

R

Section No. 2  
 Bill No. 9  
 Ironmongery

**CONSTRUCTION OF NEW MATLALA TRADITIONAL COUNCIL OFFICE  
 FOR DEPARTMENT OF COOPERATIVE GOVERNANCE HUMAN SETTLEMENTS &**

Section No. 2

Bill No. 9

Ironmongery

**COLLECTION**

Total Brought Forward from Page No.

**Page  
No**

57

58

**Amount**

**Carried Forward to Summary of Section No. 2**

R

Section No. 2

Bill No. 9

Ironmongery

**CONSTRUCTION OF NEW MATLALA TRADITIONAL COUNCIL OFFICE  
FOR DEPARTMENT OF COOPERATIVE GOVERNANCE HUMAN SETTLEMENTS &**

Item No	BILL No. 10	Quantity	Rate	Amount
	<b><u>STRUCTURAL STEELWORK</u></b>			
	<b><u>SUPPLEMENTARY PREAMBLES</u></b>			
	<b><u>Descriptions</u></b>			
	Descriptions of bolts shall be deemed to include nuts and washers			
	Descriptions of L-shaped and U-shaped anchor bolts shall be deemed to include bending, threading, nuts and washers and embedding in concrete			
	Descriptions of expansion anchors and bolts and chemical anchors and bolts shall be deemed to include nuts, washers and mortices in brickwork or concrete			
	Descriptions of L-shaped and U-shaped anchor bolts shall be deemed to include bending, threading, nuts and washers and embedding in concrete. Where anchor bolts are described as embedded in sides or soffits of concrete it shall be deemed to include holes through formwork.			
	Descriptions of expansion anchors and bolts and chemical anchors and bolts shall be deemed to include nuts, washers and mortices in brickwork or concrete.			
	<b><u>GLAVANISED STEEL COLUMNS AND BEAMS</u></b>			
	<b><u>Welded columns in single length, with flat section base, top, bearer and connection plates bolted to reinforced concrete at bottom and parallel flanged channel top</u></b>			
1	100mm x 3mm x 4.53kg/m circular hollow section column	t	0.03	
2	150 x 150 x 10mm Base plates including 4 no . holes to suite m16 bolts. bolts included	No	2	
3	150 x 150 x 10mm Top connector plates including 2 no . holes to suite m16 bolts. bolts included	No	2	
	<b>Carried Forward to Summary of Section No. 2</b>			R
	Section No. 2 Bill No. 10 Structural Steel work			
	<b>CONSTRUCTION OF NEW MATLALA TRADITIONAL COUNCIL OFFICE FOR DEPARTMENT OF COOPERATIVE GOVERNANCE HUMAN SETTLEMENTS &amp;</b>			

Item No	SECTION No. 2BILL No. 11	Quantity	Rate	Amount
	<b><u>METALWORK</u></b>			
	<b><u>PREAMBLES</u></b>			
	For Preambles see "Model Preambles For Trades"			
	<b><u>SUPPLEMENTARY PREAMBLES</u></b>			
	<b><u>Descriptions</u></b>			
	Descriptions of bolts shall be deemed to include nuts and washers			
	Descriptions of expansion anchors and bolts and chemical anchors and bolts shall be deemed to include nuts, washers and mortices in brickwork or concrete			
	Metalwork described as "bolted" shall be deemed to exclude the bolts unless otherwise described			
	<b><u>Hot-dipped double spelter galvanised mild steel grab rails formed of 32mm outside diameter x 1,6mm round section rails and 75mm diameter x 3mm flat section fixing flanges each three times holed and bolted to walls with M8 x 50mm expansion bolts</u></b>			
1	32mm Grab rail 700mm long with two 80mm return ends bolted	No	4	
	<b><u>PRESSED STEEL GATES</u></b>			
	<b><u>The following in framed and welded mild steel security gates and fixing in position complete</u></b>			
2	2100 x 900mm Steel gate comprising of 75 x 50 x 2mm square tubing outer frame and 20 x 20mm square tubing verticals at 120mm centres	No	5	
	<b>Carried to Collection</b>			R
	Section No. 2 Bill No. 11 Metalwork			
	<b>CONSTRUCTION OF NEW MATLALA TRADITIONAL COUNCIL OFFICE FOR DEPARTMENT OF COOPERATIVE GOVERNANCE HUMAN SETTLEMENTS &amp;</b>			



**PRESSED STEEL DOOR FRAMES**

NOTE

The rates for door frames shall include for welding of all hinge pins at completion

**1,2mm thick Double rebated mild steel door frames suitable for half brick walls. Frame complete with one pair standard butt hinges and factory applied primer**

3	Frame for door 813 x 2032mm high	No	6
---	----------------------------------	----	---

4	Frame for door 813 x 2032mm high and fixed fanlight 305mm high	No	10
---	--	----	----

**1,2mm thick Double rebated mild steel door frames suitable for one brick walls. Frame complete with one pair standard butt hinges and factory applied primer**

5	Frame for door 813 x 2 032mm high	No	8
---	-----------------------------------	----	---

6	Frame for door 813 x 2032mm high and fixed fanlight 305mm high	No	2
---	--	----	---

7	Frame for door 914 x 2 032mm high	No	2
---	-----------------------------------	----	---

8	Frame for door 1 511 x 2 032mm high	No	1
---	-------------------------------------	----	---

**STEEL RECORDROOM AND STRONGROOM DOORS, VENTILATORS, ETC**

**"Mutual" strongroom doors etc suitable for 230mm walls fixed to brickwork or concrete**

9	"Mutual DS3 CAT2" strongroom door and frame 775 x 1875mm high overall with a mass of 380kg	No	2
---	--	----	---

**STEEL WINDOWS, DOORS, ETC**

Carried to Collection

R

Section No. 2  
 Bill No. 11  
 Metalwork

**CONSTRUCTION OF NEW MATLALA TRADITIONAL COUNCIL OFFICE FOR DEPARTMENT OF COOPERATIVE GOVERNANCE HUMAN SETTLEMENTS &**

**Standard residential windows with 10mm square burglar bars to fixed lights and opening sashes**

10	Window type NE1, 533 x 654mm high	No	8
11	Window type NCT1S, 533 X 949mm high	No	3
	Window type ND2, 1022 x 1245mm high	No	17
12	Window type ND4, 1511 x 1245mm high	No	8
13	Window type NE8, 1022 x 654mm high	No	6
14	Window type NG2, 1022 x 359mm high	No	6

**ALUMINIUM SLIDING DOORS**

**Natural anodised sliding doors as per "AAMSA specification" system, complete with subframes, ironmongery, glass, sealing, etc and fixing to brickwork or concrete**

15	Standard door type OXXO 147 (4221), 4100 x 2095mm high (W8)	No	1
----	---	----	---

**ALUMINIUM SHOPFRONTS**

**Natural anodized shopfronts as per AAMSA spec complete with subframes, ironmongery, glass, sealing, etc and fixing to brickwork or concrete**

16	Purpose made shopfront, 6780 x 2510mm high with one double door 1800 x 2510mm high with two corner and side fixture of 2580 x 2510mm each (W7)	No	1
----	--	----	---

Carried to Collection

R

Section No. 2  
 Bill No. 11  
 Metalwork

**CONSTRUCTION OF NEW MATLALA TRADITIONAL COUNCIL OFFICE  
 FOR DEPARTMENT OF COOPERATIVE GOVERNANCE HUMAN SETTLEMENTS &**

Section No. 2

Bill No. 11

Metalwork

**COLLECTION**

Total Brought Forward from Page No.

**Page  
No**

**Amount**

61

62

63

**Carried Forward to Summary of Section No. 2**

R

Section No. 2

Bill No. 11

Metalwork

**CONSTRUCTION OF NEW MATLALA TRADITIONAL COUNCIL OFFICE  
FOR DEPARTMENT OF COOPERATIVE GOVERNANCE HUMAN SETTLEMENTS &**

Item No		Quantity	Rate	Amount
	<b><u>SECTION No. 2BILL No. 12</u></b>			
	<b><u>PLASTERING</u></b>			
	<b><u>PREAMBLES</u></b>			
	For Preambles see "Model Preambles For Trades"			
	<b><u>SCREEDS</u></b>			
	<b><u>Screeds on concrete</u></b>			
1	25mm Thick on floors	m2	623	
	<b><u>INTERNAL PLASTER</u></b>			
	<b><u>Cement plaster on brickwork</u></b>			
2	On vertical surfaces	m2	1 448	
3	On narrow widths	m2	20	
	<b><u>EXTERNAL PLASTER</u></b>			
	<b><u>Cement plaster on brickwork</u></b>			
4	On walls	m2	26	
5	On narrow width	m2	1	
	<b><u>CORNER PROTECTORS,DIVIDING STRIPS,ETC</u></b>			
6	30 X 3mm Flat section brass dividing strip between different floor finishes	m	7	
	<b>Carried Forward to Summary of Section No. 2</b>			
	Section No. 2			
	Bill No. 12			
	Plastering			
	<b>CONSTRUCTION OF NEW MATLALA TRADITIONAL COUNCIL OFFICE FOR DEPARTMENT OF COOPERATIVE GOVERNANCE HUMAN SETTLEMENTS &amp;</b>			
				R

Item No	SECTION No. 2BILL No. 13	Quantity	Rate	Amount
	<p><b><u>TILING</u></b></p> <p><b><u>PREAMBLES</u></b></p> <p>For Preambles see "Model Preambles For Trades"</p> <p><b><u>SUPPLEMENTARY PREAMBLES</u></b></p> <p>Unless described as "fixed with adhesive to plaster (plaster elsewhere)" descriptions of tiling on brick or concrete walls columns, etc shall be deemed to include 1:4 cement plaster backing and descriptions of tiling on concrete floors etc shall be deemed to include 1:3 plaster bedding</p> <p><b><u>WALL TILING</u></b></p> <p><b><u>198 x 198 x 6mm White glazed ceramic wall tiles fixed with an approved tile adhesive to plaster (elsewhere measured) and jointed with waterproofing coloured jointing compound</u></b></p>			
1	On vertical surfaces	m2	137	
	<p><b><u>FLOOR TILING</u></b></p> <p><b><u>Approved 600 x 600mm bodied Porcelain floor tiles (PC Amount of R200-00 excluding VAT) fixed on 25mm screed (elsewhere measured ) flush pointed with tinted waterproof jointing compound and approved adhesive</u></b></p>			
2	On floors and landings	m2	623	
3	Skirting 75mm high (of cut tiles)	m	338	
	<p><b>Carried Forward to Summary of Section No. 2</b></p> <p>Section No. 2 Bill No. 13 Tiling</p> <p><b>CONSTRUCTION OF NEW MATLALA TRADITIONAL COUNCIL OFFICE FOR DEPARTMENT OF COOPERATIVE GOVERNANCE HUMAN SETTLEMENTS &amp;</b></p>			R

Item No		Quantity	Rate	Amount
	<b><u>SECTION No. 2BILL No. 14</u></b>			
	<b><u>PLUMBING AND DRAINAGE (PROVISIONAL)</u></b>			
	<b><u>PREAMBLES</u></b>			
	For Preambles see "Model Preambles For Trades"			
	<b><u>RAINWATER DISPOSAL</u></b>			
	<b><u>0.6mm Galvanised sheet steel gutters and rainwater pipes with powder coated finish on outside.</u></b>			
1	100 x 75mm Rainwater pipes	m	159	
2	Extra over gutter for stopped end	No	2	
3	Extra over gutter for angle	No	2	
4	Extra over gutter for outlet for 75 x 75mm pipe	No	13	
5	75 x 75mm diameter rainwater pipes fixed to columns, etc	m	36	
6	Extra over rainwater pipe for bend	No	26	
7	Extra over rainwater pipe for eaves or plinth offset	No	13	
8	Extra over rainwater pipes for shoe	No	13	
	<b><u>STORMWATER CHANNEL</u></b>			
	<b><u>Rectangular cast in situ concrete surface water channels</u></b>			
9	100mm Thick shallow equal 'V' shaped rectangular 20MPa concrete drainage channel 1m wide overall including all earthworks, formwork and ref 193 mesh reinforcement cast in panels not exceeding 3m long, backfilling etc and finishing tops and sides smooth with woodfloat	m	1	
	<b>Carried to Collection</b>			R
	Section No. 2 Bill No. 14 Plumbing and Drainage (Provisional)			
	<b>CONSTRUCTION OF NEW MATLALA TRADITIONAL COUNCIL OFFICE FOR DEPARTMENT OF COOPERATIVE GOVERNANCE HUMAN SETTLEMENTS &amp;</b>			

10	Extra over for angles, intersections, ends, dressing into sides of catchpits, etc	No	1	
	<b><u>SANITARY FITTINGS</u></b>			
	<b><u>Approved Water Tanks, etc</u></b>			
11	5000 litre Plastic Water tank for rain harvesting including installation	No	3	
	<b><u>'Vaal' or equally approved</u></b>			
12	635 x 485mm "Lotus" White vitreous china basin (code 7026) with three semi-punched tap holes and 301 slotted waste with plug and chain, with intergrated overflow mounted using universal half pedestal and hanger mechanism (code 715221)	No	11	
	<b><u>'Vaal' or equally approved</u></b>			
13	"Concorde" White vitreous china close coupled WC suite comprising 90 degrees outlet closed rim washdown pan (product code 7727700) and matching 9 litre top dual flush cistern (product code 7104DT) complete with lid, fitments and purpose made wooden seat (Code 852720)	No	5	
14	"Protea" Paraplegic white vitreous china floor mounted paraplegic WC pan (product code 750200) comprising 90 degrees outlet pan (product code 750200) and matching 9 litre cistern (product code 710631) including lid, fitment and purpose made chrome plated side flush lever	No	2	
	<b><u>'Vaal' or equally approved</u></b>			
15	Approved flat back wall mounted bowl urinal fixed with matching brackets, one C.P. flush valve complete with flush pipes as required and one approved C.P. plated bottle trap	No	2	
	<b>Carried to Collection</b>			R
	Section No. 2			
	Bill No. 14			
	Plumbing and Drainage (Provisional)			
	<b>CONSTRUCTION OF NEW MATLALA TRADITIONAL COUNCIL OFFICE FOR DEPARTMENT OF COOPERATIVE GOVERNANCE HUMAN SETTLEMENTS &amp;</b>			

	<b><u>'Franke' sink or equally approved</u></b>			
16	Approved 535 x 455mm Type 304 Stainless steel drop sink with 100mm splash back, grid, etc on 25 x 25mm brackets all as supplied by manufacturers installed 500 mm F.F.L, one 20mm C.P hose bib cock 1000mm F.F.L, one 40mm diameter C.P outlet an one 40mm diameter C.P bottle trap	No	1	
17	Single bowl 900mm x 500mm Type 304 stainless steel inlay type fixed onto kitchen unit, one approved C.P mixer, one 40mm diameter C.P outlet and one one approved 40mm diameter C.P. bottle trap	No	1	
	<b><u>WASTE UNIONS</u></b>			
	<b><u>Cobra Watertech</u></b>			
18	40mm 316 CP sink waste union	No	2	
	<b><u>TRAPS ETC</u></b>			
	<b><u>Traps, etc. including joints to steel pipes and/or fittings unless otherwise described</u></b>			
19	40mm Deep seal "P" or "S" trap	No	14	
	<b><u>Chromium plated</u></b>			
20	Flexible connectors, etc.	No	24	
	<b><u>TAPS, VALVES, ETC</u></b>			
	<b><u>Valves, etc. including joints to steel pipes and/or fittings unless otherwise described</u></b>			
21	15mm Chromium plated full way ballcock shut-off control valve with screw type control	No	2	
22	15mm Brass stopcock	No	28	
	<b><u>Cobra Watertech or equally approved</u></b>			
23	15mm Chromium sink mixer (Code 266/04/10)	No	1	
24	Selene 953, pillartap	No	21	
	<b>Carried to Collection</b>			R
	Section No. 2			
	Bill No. 14			
	Plumbing and Drainage (Provisional)			
	<b>CONSTRUCTION OF NEW MATLALA TRADITIONAL COUNCIL OFFICE FOR DEPARTMENT OF COOPERATIVE GOVERNANCE HUMAN SETTLEMENTS &amp;</b>			



**WATER SUPPLIES****Class 1 copper pipes with capillary couplings**

25	15mm Pipe fixed in and including chase in walls	m	181
----	---	---	-----

26	22mm Pipe fixed in and including chase in walls	m	60
----	---	---	----

**Extra over copper pipes for capillary fittings**

27	15mm Fittings	No	58
----	---------------	----	----

28	22mm Fittings	No	20
----	---------------	----	----

**SUBSOIL DRAINAGE****uPVC pipes**

29	50mm Pipes fixed to walls, etc.	m	48
----	---------------------------------	---	----

30	110mm Pipes fixed to walls, etc.	m	16
----	----------------------------------	---	----

31	110mm Pipes laid in and including trenches not exceeding 1m deep	m	180
----	--	---	-----

**Extra over uPVC pipes for fittings**

32	50mm Bend	No	20
----	-----------	----	----

33	50mm Access bend	No	5
----	------------------	----	---

34	110mm Bend	No	24
----	------------	----	----

35	110mm Tee junction	No	10
----	--------------------	----	----

36	110 x 50 mm Reducing junction	No	5
----	-------------------------------	----	---

**THE FOLLOWING IN SEPTIC TANK AND FRENCH DRAIN**

Carried to Collection

R

Section No. 2

Bill No. 14

Plumbing and Drainage (Provisional)

**CONSTRUCTION OF NEW MATLALA TRADITIONAL COUNCIL OFFICE  
FOR DEPARTMENT OF COOPERATIVE GOVERNANCE HUMAN SETTLEMENTS &**

<b><u>Earthworks for Septic tank and Conservative drain</u></b>			
37	Excavation in earth excavation 2m and not exceeding 4m deep	m3	1
38	Excavation in earth excavation n.e 2m	m3	1
<b><u>Earth filling of clean drain rock</u></b>			
39	As backfilling for drain pipe	m3	1
<b><u>Earth filling obtained from the excavations and/or prescribed stock piles on site compacted to 90% Mod AASHTO density</u></b>			
40	As backfilling to drain pipe	m3	1
<b><u>Concrete, Formwork and Reinforcement for Septic tank</u></b>			
41	20Mpa Reinforced Concrete in bottoms	m3	1
42	25Mpa Reinforced Concrete in slab	m3	1
43	Type 193 fabric reinforcement in concrete bottoms	m2	1
44	Type 617 fabric reinforcement in concrete bottoms	m2	1
<b><u>Masonry for Septic tank</u></b>			
45	Half Brick wall	m2	1
46	One Brick wall	m2	1
<b><u>Plastering for Septic tank</u></b>			
47	13mm thick Cement plaster on brick walls	m2	1
48	610 x 610 x 97kg Type 2B Mild steel Manhole cover and frame	No	1
<b><u>Sundries</u></b>			
49	110 diameter drain	m	1
50	Double layer of Geofabric	m2	1
<b>Carried to Collection</b>			R
Section No. 2			
Bill No. 14			
Plumbing and Drainage (Provisional)			
<b>CONSTRUCTION OF NEW MATLALA TRADITIONAL COUNCIL OFFICE FOR DEPARTMENT OF COOPERATIVE GOVERNANCE HUMAN SETTLEMENTS &amp;</b>			

**FIRE SERVICES****Fire appliances including piping, etc**

51	4,5kg DCP dry powder portable fire extinguisher on and including wrought Meranti backboard size 520 x 100 x 22mm thick plugged and screwed to wall and finished with two coats of polyurethane varnish, including 120 x 20 x 2mm mild steel strip bent to form hook	No	6
52	Fire hose reel complete with 30m rubber hose, chromium plated stopcock, shut-off nozzle and wall bracket bolted to wall with and including expansion bolts	No	2

**BUDGETARY ALLOWANCES**

53	Water to supply fire appliances		Item	
54	Provide the sum of R 16 500.00 (Fifteen Thousand Rand) for the construction of a 3 x Plinths for the Water Tanks (elsewhere measured)		Item	16 500.00
55	Provide the sum of R 80 000.00 (Eighty Thousand Rand) for the construction of a Septic Tank and French Drain		Item	

**ELECTRIC WATER HEATERS**

56	100 Litre horizontal wall mounted electric water heater	No	1
----	---	----	---

**TESTING**

57	Testing soil drainage system		Item
58	Testing waste pipe system		Item
59	Testing water pipe system		Item

Carried to Collection

R

Section No. 2

Bill No. 14

Plumbing and Drainage (Provisional)

**CONSTRUCTION OF NEW MATLALA TRADITIONAL COUNCIL OFFICE  
FOR DEPARTMENT OF COOPERATIVE GOVERNANCE HUMAN SETTLEMENTS &**

Section No. 2

Bill No. 14

Plumbing and Drainage (Provisional)

**COLLECTION**

Total Brought Forward from Page No.

**Page  
No**

**Amount**

67

68

69

70

71

72

**Carried Forward to Summary of Section No. 2**

R

Section No. 2

Bill No. 14

Plumbing and Drainage (Provisional)

**CONSTRUCTION OF NEW MATLALA TRADITIONAL COUNCIL OFFICE  
FOR DEPARTMENT OF COOPERATIVE GOVERNANCE HUMAN SETTLEMENTS &**

Item No		Quantity	Rate	Amount
	<b><u>SECTION No. 2BILL No. 15</u></b>			
	<b><u>GLAZING</u></b>			
	<b><u>PREAMBLES</u></b>			
	For Preambles see "Model Preambles For Trades"			
	<b><u>GLAZING TO STEEL WITH PUTTY</u></b>			
	<b><u>4mm Clear float glass</u></b>			
1	Panes exceeding 0,1m <sup>2</sup> and not exceeding 0,5m <sup>2</sup>	m2	3	
2	Panes exceeding 0,5m <sup>2</sup> and not exceeding 2m <sup>2</sup>	m2	37	
	<b><u>4mm obscure glass</u></b>			
3	Panes exceeding 0,1m <sup>2</sup> and not exceeding 0,5m <sup>2</sup>	m2	5	
	<b><u>MIRRORS, SHELVES, ETC</u></b>			
	<b><u>6 mm Silvered float glass copper backed mirrors</u></b>			
4	600 x 450 x 6mm Thick SABS Approved mirror with building paper at back fixed against wall with four C.P. capped mirror screens in position as shown on detail layout	No	11	
	<b>Carried Forward to Summary of Section No. 2</b>			
	Section No. 2			
	Bill No. 15			
	Glazing			
	<b>CONSTRUCTION OF NEW MATLALA TRADITIONAL COUNCIL OFFICE FOR DEPARTMENT OF COOPERATIVE GOVERNANCE HUMAN SETTLEMENTS &amp;</b>			
				R

Item No		Quantity	Rate	Amount
	<b><u>SECTION No. 2BILL No. 16</u></b>			
	<b><u>PAINTWORK</u></b>			
	<b><u>PREAMBLES</u></b>			
	For Preambles see "Model Preambles For Trades"			
	<b><u>ON FLOATED PLASTER</u></b>			
	<b><u>Prepare, stop and apply one coat alkali resistant primer, one coat universal undercoat and two full coats eggshell enamel paint</u></b>			
1	On internal plastered walls	m2	1 468	
2	On external plastered walls	m2	27	
	<b><u>ON PLASTER BOARD</u></b>			
	<b><u>One coat primer and two coats interior quality PVA emulsion paint</u></b>			
3	On ceilings and cornices	m2	623	
	<b><u>ON FIBRE CEMENT</u></b>			
	<b><u>One coat primer and two coats exterior quality PVA emulsion paint</u></b>			
	On fascias and barge boards	m2	95	
	<b><u>ON METAL</u></b>			
	<b><u>One primer, one undercoat and two coats alkyd enamel paint on steel</u></b>			
4	On grille gates and screens (both sides measured on flat)	m2	19	
	<b>Carried to Collection</b>			R
	Section No. 2 Bill No. 16 Paintwork			
	<b>CONSTRUCTION OF NEW MATLALA TRADITIONAL COUNCIL OFFICE FOR DEPARTMENT OF COOPERATIVE GOVERNANCE HUMAN SETTLEMENTS &amp;</b>			



Section No. 2

Bill No. 16

Paintwork

**COLLECTION**

Total Brought Forward from Page No.

**Page  
No**

75

76

**Amount**

**Carried Forward to Summary of Section No. 2**

R

Section No. 2

Bill No. 16

Paintwork

**CONSTRUCTION OF NEW MATLALA TRADITIONAL COUNCIL OFFICE  
FOR DEPARTMENT OF COOPERATIVE GOVERNANCE HUMAN SETTLEMENTS &**



Bill No	SECTION SUMMARY - BUILDING WORK	Page No	Amount
1	Earthworks (Provisional)	37	
2	Concrete, Formwork & Reinforcement	40	
3	Masonry	44	
4	Waterproofing	47	
5	Roofwork	48	
6	Carpentry	52	
7	Ceilings, partitions and Access Flooring	55	
8	Floor Coverings, Wall Linings, etc.	56	
9	Ironmongery	59	
10	Structural Steel work	60	
11	Metalwork	64	
12	Plastering	65	
13	Tiling	66	
14	Plumbing and Drainage (Provisional)	73	
15	Glazing	74	
16	Paintwork	77	
	<b>Carried to Final Summary</b>		R
	Section No. 2 <b>CONSTRUCTION OF NEW MATLALA TRADITIONAL COUNCIL OFFICE FOR DEPARTMENT OF COOPERATIVE GOVERNANCE HUMAN SETTLEMENTS &amp;</b>		

Item No		Unit	Quantity	Rate	Amount
	<b><u>SECTION No. 4</u></b>				
	<b><u>BILL NO. 1</u></b>				
	<b><u>PROVISIONAL SUMS</u></b>				
	<b><u>PREAMBLES</u></b>				
	For Preambles see "Model Preambles For Trades"				
	<b><u>ELECTRICAL WORKS</u></b>				
1	Provide the sum of R 1,200,000.00 (One million two hundred thousand Rand) for the supply and installation of Electrical Works.		Item		1 200 000.00
2	Add for profit upon above, if required.		Item		
3	Add for attendance		Item		
	<b><u>MECHANICAL WORKS</u></b>				
4	Provide an amount of R400,000.00(Four hundred thousand Rand) for the installation of Mechanical Works including Fire detectors		Item		400 000.00
5	Add for profit upon above, if required		Item		
6	Add for attendance		Item		
	<b><u>BORE HOLE</u></b>				
7	Provide the sum of R 200 000.00 (Two Hundred Thousand rand) for the drilling of a Bore Hole including equipping, supply and installation of a 5000 litre "Jojo" or equally approved Tank and a 6m "Jojo" or equally approved Steel Stand including pipe connection to the building and a pressure pump secured in a suitable steel cage complete.		Item		200 000.00
8	Add for profit upon above, if required.		Item		
9	Add for attendance		Item		
	<b>Carried to Collection</b>				R
	Section No. 3				
	Bill No. 1				
	PROVISIONAL SUMS				
	<b>CONSTRUCTION OF NEW MATLALA TRADITIONAL COUNCIL OFFICE FOR DEPARTMENT OF COOPERATIVE GOVERNANCE HUMAN SETTLEMENTS &amp;</b>				

**GEOHYDROLOGICAL SURVEY**

10	Provide the sum of R50 000.00(Fifty Thousand rand) for Geohydrological survey and the production of borehole reports.	Item	50 000.00
11	Add for profit upon above, if required	Item	
12	Add for attendance	Item	

**JOINERY FITTINGS**

13	Provide the sum of R 150 000-00 (One Hundred and Fifty thousand Rand) for the supply, delivery and installation of Joinery Fittings including Granite tops (Kitchen Unit, Fixed Benches, etc) complete.	Item	150 000.00
14	Add for profit upon above, if required.	Item	
15	Add for attendance	Item	

**SIGNAGE**

16	Provide the sum of R 25 000-00 (Twenty Five thousand rand) for supply and installation signage complete	Item	25 000.00
17	Add for profit upon above, if required.	Item	
18	Add for attendance	Item	

**BUDGETARY ALLOWANCES**

19	Provide the sum of R 275 000.00 (Two hundred and Seventy Five thousand Rand) for the construction of a Guard House	Item	275 000.00
20	Provide the sum of R 150 000-00 (One hundred and Fifty thousand Rand) for unforeseen foundation conditions	Item	150 000.00
21	Provide the sum of R 220 000-00 (Two hundred and Twenty thousand Rand) for Stormwater Drainage	Item	220 000.00

Carried to Collection

R

Section No. 3

Bill No. 1

PROVISIONAL SUMS

**CONSTRUCTION OF NEW MATLALA TRADITIONAL COUNCIL OFFICE  
FOR DEPARTMENT OF COOPERATIVE GOVERNANCE HUMAN SETTLEMENTS &**

Section No. 3

Bill No. 1

PROVISIONAL SUMS

**COLLECTION**

Total Brought Forward from Page No.

**Page  
No**

79

80

**Amount**

**Carried to Final Summary**

R

Section No. 3

Bill No. 1

PROVISIONAL SUMS

**CONSTRUCTION OF NEW MATLALA TRADITIONAL COUNCIL OFFICE  
FOR DEPARTMENT OF COOPERATIVE GOVERNANCE HUMAN SETTLEMENTS &**

Item No	<b><u>SECTION No. 3BILL No. 1</u></b>	Quantity	Rate	Amount
	<b><u>GENERAL SITEWORKS</u></b>			
	<b><u>DEMOLITIONS</u></b>			
	<b><u>Demolishing and removing</u></b>			
1	Single storey building with pitched roof, 23.2x 7.7 m on plan and 2,9m high at eaves, comprising unreinforced concrete surface bed, 220mm external walls, 110mm internal walls and carted away to a dumping site located by the contractor.	No	1	
2	Single storey building with pitched roof, 10.8 x 22.7 m on plan and 2,9m high at eaves, comprising unreinforced concrete surface bed, 220mm external walls, 220mm internal walls, burnt trusses and carted away to a dumping site located by the contractor.	No	1	
3	Single storey building with pitched roof, 7.7x4 m on plan and 2,9m high at eaves, comprising unreinforced concrete surface bed, 220mm external walls, 200mm internal walls, burnt trusses and carted away to a dumping site located by the contractor.	No	1	
4	Single storey building with pitched roof, 9 x 4 m on plan and 2,9m high at eaves, comprising unreinforced concrete surface bed, 220mm external walls, 220mm internal walls, burnt trusses and carted away to a dumping site located by the contractor.	No	1	
5	Breaking down and removal of 75mm thick concrete slab including cart away to a dumping site located by the contractor.	m2	277	
	<b><u>SITE CLEARANCE</u></b>			
	<b><u>Site Clearance, etc</u></b>			
6	Digging up and removing rubbish, debris and trees n.e 200mm girth, bush,etc	m2	2 570	
	<b>Carried to Collection</b>			R
	Section No. 4 Bill No. 1 General Siteworks			
	<b>CONSTRUCTION OF NEW MATLALA TRADITIONAL COUNCIL OFFICE FOR DEPARTMENT OF COOPERATIVE GOVERNANCE HUMAN SETTLEMENTS &amp;</b>			

**BUDGETARY ALLOWANCES**

7 Provide the sum of R 30 000.00 (Thirty Thousand Rand) for the construction of a Landscaping and Brick walls in front of Reception Area

Item

30 000.00

**Carried to Collection**

R

Section No. 4  
 Bill No. 1  
 General Siteworks

**CONSTRUCTION OF NEW MATLALA TRADITIONAL COUNCIL OFFICE  
 FOR DEPARTMENT OF COOPERATIVE GOVERNANCE HUMAN SETTLEMENTS &**

Section No. 4

Bill No. 1

General Siteworks

**COLLECTION**

Total Brought Forward from Page No.

**Page  
No**

82

83

**Amount**

**Carried Forward to Summary of Section No. 4**

R

Section No. 4

Bill No. 1

General Siteworks

**CONSTRUCTION OF NEW MATLALA TRADITIONAL COUNCIL OFFICE  
FOR DEPARTMENT OF COOPERATIVE GOVERNANCE HUMAN SETTLEMENTS &**

Item No	<b><u>SECTION No. 3BILL No. 2</u></b>	Quantity	Rate	Amount
	<b><u>ROADS AND PARKING</u></b>			
	<b><u>PREAMBLES</u></b>			
	For Preambles see "Model Preambles For Trades"			
	<b><u>EXCAVATION, FILLING, ETC OTHER THAN BULK</u></b>			
	<b><u>Excavation</u></b>			
1	Open face excavation in earth to reduce levels	m3	602	
2	Extra over all excavations for carting away surplus material from excavations and/or from stockpiles on site to a dumping site to be located by the Contractor	m3	301	
3	Extra over open face excavations in earth for excavations in soft rock	m3	60	
4	Extra over open face excavations in earth for excavations in hard rock	m3	30	
5	Allow for keeping all excavations entirely free from water and mud		Item	
	<b><u>Filling, etc.</u></b>			
6	Earth filling from the excavations to make up levels around buildings compacted to 90% modified AASHTO density	m3	301	
7	Imported natural gravel material (minimum G5/6 material to TRH14) supplied by the Contractor and brought onto site from commercial sources in filling under paving, etc compacted in layers not exceeding 150mm thick to 90% modified AASHTO density	m3	622	
8	Base layer of imported natural gravel material (minimum G1 material to TRH14) supplied by the Contractor and brought onto site from commercial sources and compacted to 100% modified AASHTO density	m3	151	
	<b>Carried to Collection</b>			R
	Section No. 4 Bill No. 2 Roads and Parking			
	<b>CONSTRUCTION OF NEW MATLALA TRADITIONAL COUNCIL OFFICE FOR DEPARTMENT OF COOPERATIVE GOVERNANCE HUMAN SETTLEMENTS &amp;</b>			



9	Compaction of ground surface under pavings, etc. including scarifying for a depth of 150mm, breaking down oversize material, adding suitable material where necessary and compact to 93% modified AASHTO density	m2	1 004	
10	50mm Thick clean, dry, riversand layer treated with an approved weed killer at the rate of 50 grams per square metre, spread and levelled to receive paving blocks (elsewhere)	m2	1 004	
<b>Tests</b>				
11	Tests to determine the degree of compaction, etc. of ground or filling	No	20	
<b>PRECAST CONCRETE</b>				
12	85mm Interlocking concrete paving blocks in accordance with SABS Specification 1058 and laid to falls on sand layer (elsewhere) with joints filled in with sand and vibrated, including all straight cutting	m2	1 004	
13	Mountable kerbing to SABS 927 Fig. 3 in 1m lengths with 10mm wide butt joints filled in with (1:3) cement/sand mortar and pointed with grooved half round joints and 10mm wide open butt joints at 3m centres including 15MPa/19mm mass concrete bedding size 30mm thick x 400mm wide and 20MPa/19mm mass concrete hunching size 112.5mm long x 112.5mm high x 85mm thick at joints and backfilling at back of kerbs, topsoiled and levelled to adjacent surfaces	m	140	
<b>Carried to Collection</b>				R
Section No. 4 Bill No. 2 Roads and Parking <b>CONSTRUCTION OF NEW MATLALA TRADITIONAL COUNCIL OFFICE FOR DEPARTMENT OF COOPERATIVE GOVERNANCE HUMAN SETTLEMENTS &amp;</b>				

Section No. 4

Bill No. 2

Roads and Parking

**COLLECTION**

Total Brought Forward from Page No.

**Page  
No**

85

86

**Amount**

**Carried Forward to Summary of Section No. 4**

R

Section No. 4

Bill No. 2

Roads and Parking

**CONSTRUCTION OF NEW MATLALA TRADITIONAL COUNCIL OFFICE  
FOR DEPARTMENT OF COOPERATIVE GOVERNANCE HUMAN SETTLEMENTS &**

Item No	SECTION No. 3BILL No. 3	Quantity	Rate	Amount
	<b><u>FENCING AND GATES</u></b>			
	<b><u>SUPPLEMENTARY PREAMBLES</u></b>			
	For Preambles see "Supplementary Model Preambles For Trades"			
	<b><u>Reinforced Precast concrete palisade fence, finished smooth on exposed surfaces, including site clearance and preparation of ground.</u></b>			
1	Palisade fence 3.0m high above ground level over flat terrain with 80mm tapering to 220mm x 3m long intermediate and end posts at centres cast into concrete bases, 145 x 80mm x 2m long top and bottom horizontal rails at intersections, including stopping off bolt holes with cement holes	m	300	
	<b><u>Gates</u></b>			
2	Galvanised mild steel sliding gate size 5,500mm wide x 3,000mm high overall comprising 2mm thick x 76mm wide x 50mm hollow section frame and running on 50 x 50 x 2mm thick angle section track embedded into and including 400mm wide x 600mm deep 25Mpa concrete ground beam and excavations for the same, filling, carting away of excess excavated material,etc	No	1	
	<b>Carried Forward to Summary of Section No. 4</b>			R
	Section No. 4 Bill No. 3			
	Fencing and gates			
	<b>CONSTRUCTION OF NEW MATLALA TRADITIONAL COUNCIL OFFICE FOR DEPARTMENT OF COOPERATIVE GOVERNANCE HUMAN SETTLEMENTS &amp;</b>			

**SECTION SUMMARY - EXTERNAL WORKS**

Bill No		Page No	Amount
1	General Siteworks	84	
2	Roads and Parking	87	
3	Fencing and gates	88	
<b>Carried to Final Summary</b>			R
Section No. 4 <b>CONSTRUCTION OF NEW MATLALA TRADITIONAL COUNCIL OFFICE                      FOR DEPARTMENT OF COOPERATIVE GOVERNANCE HUMAN SETTLEMENTS &amp;</b>			

Item No	<u>Earthworks</u>	Quantity	Rate	Amount
1	<u>Open face excavation over sloping site</u>  Open face excavation to form platform under parking areas etc and depositing excavated material over site including haulage not exceeding 1km from perimeter of excavations	m3	956	
2	<u>Extra over all excavations for carting away</u>  Surplus material from stock piles on site to a dumping site to be located by the contractor	m3	717	
3	<u>Compaction of surfaces</u>  Compaction of ground surface areas etc. by wetting and compacting with vibratory roller	m2	1 593	
<b>Carried to Collection</b>				R
Section No. 5 Bill No. 1 EARTH WORKS <b>CONSTRUCTION OF NEW MATLALA TRADITIONAL COUNCIL OFFICE            FOR DEPARTMENT OF COOPERATIVE GOVERNANCE HUMAN SETTLEMENTS &amp;</b>				

4	<p><u>Keeping excavations free of water</u></p> <p>Keeping excavations free of all water other than subterranean water</p>		Item	
5	<p><u>Earth filling supplied by the contractor overplatform base etc</u></p> <p>Over site of G6 material in accordance with SABS 1200 DM compacted to 95% Mod AASHTO density in 150mm layers</p>	m3	956	
6	<p><u>Prescribed density tests on filling</u></p> <p>In-situ dry density (sand replacement) test in accordance with method A10 (a) of TMH 1</p>	No	120	
<p><b>Carried to Collection</b></p>				
<p>Section No. 5                  Bill No. 1                  EARTH WORKS  <b>CONSTRUCTION OF NEW MATLALA TRADITIONAL COUNCIL OFFICE                  FOR DEPARTMENT OF COOPERATIVE GOVERNANCE HUMAN SETTLEMENTS &amp;</b></p>				<p>R</p>

Section No. 5

Bill No. 1

EARTH WORKS

**COLLECTION**

Total Brought Forward from Page No.

**Page  
No**

90

91

**Amount**

**Carried to Final Summary**

R

Section No. 5

Bill No. 1

EARTH WORKS

**CONSTRUCTION OF NEW MATLALA TRADITIONAL COUNCIL OFFICE  
FOR DEPARTMENT OF COOPERATIVE GOVERNANCE HUMAN SETTLEMENTS &**

Section No	FINAL SUMMARY	Page No	Amount
1	PRELIMINARIES	34	
2	BUILDING WORK	78	
3	PROVISIONAL SUMS	81	
4	EXTERNAL WORKS	89	
5	PLATFORM CONSTRUCTION	92	
	Sub-total		R
	<u>Contingencies</u>		
	Allow an Amount of R 400 000.00 (Four hundred Thousand) for contingencies to be used as directed by the Project Manager and to be deducted in full if not used.	Item	400 000.00
	Sub-total		R
	<u>Value Added Tax</u>		
	Allow for Value Added Tax (15%)		R
	<b>CARRIED TO FORM OF TENDER</b>		R
	<b>CONSTRUCTION OF NEW MATLALA TRADITIONAL COUNCIL OFFICE FOR DEPARTMENT OF COOPERATIVE GOVERNANCE HUMAN SETTLEMENTS &amp;</b>		





## PART C5: SCOPE OF WORKS

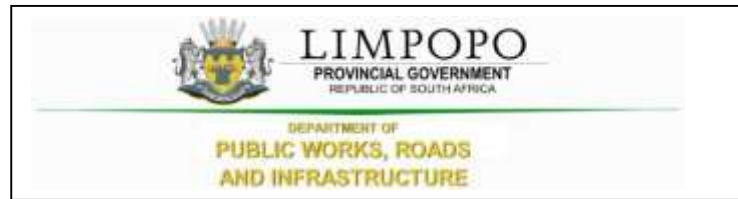

## C5.1 SCOPE OF WORKS

### Overview of the works

The project comprises the construction of the following:

1. Office Building
2. Guard House
3. Electrical Works
4. Mechanical Works (Air-conditioners & Fire Detection)
5. Borehole
6. Fencing
7. Open paved parking
8. In accordance with the drawings and specifications that will be provided to the contractor.

The Contractor shall provide sufficient qualified technical staff, field staff, and safety personnel to ensure the Works under this contract be satisfactorily carried out safely and meeting the performance targets and programs. The Contractor shall also provide competent attendant(s) to monitor any works in relation to the scope of works.



## **PART C6: EPWP INFRASTRUCTURE GUIDELINE 2015**

### PART C6: EPWP INFRASTRUCTURE GUIDELINE 2015



**public works**

Department:  
Public Works  
REPUBLIC OF SOUTH AFRICA



**EXPANDED PUBLIC WORKS PROGRAMME**



# **GUIDELINES FOR THE IMPLEMENTATION OF LABOUR-INTENSIVE INFRASTRUCTURE PROJECTS UNDER THE EXPANDED PUBLIC WORKS PROGRAMME (EPWP)**

**THIRD EDITION 2015**







public works

Department:  
Public Works  
REPUBLIC OF SOUTH AFRICA



EXPANDED PUBLIC WORKS PROGRAMME

# GUIDELINES FOR THE IMPLEMENTATION OF LABOUR-INTENSIVE INFRASTRUCTURE PROJECTS UNDER THE EXPANDED PUBLIC WORKS PROGRAMME (EPWP)

---

THIRD EDITION 2015

---



public works

Department:  
Public Works  
REPUBLIC OF SOUTH AFRICA



EXPANDED PUBLIC WORKS PROGRAMME

## **Acknowledgement**

The Department of Public Works (DPW) would like to thank the construction industry and other stakeholders for their invaluable contributions during preparation of these Guidelines. These include the DPW/EPWP officials, ILO National and Limpopo Technical Assistance teams, Consulting Engineers South Africa (CESA), Engineering Council of South Africa (ECSA), the South African Institution of Civil Engineers (SAICE), the academia and individuals from both the public and private sectors.

# TABLE OF CONTENTS

## CONTENTS

<b>FOREWORD</b> .....	<b>iii</b>
<b>PREFACE</b> .....	<b>iv</b>
<b>AMENDMENTS TO THE SECOND EDITION INCORPORATED IN THIS THIRD EDITION</b> .....	<b>v</b>
<b>ABBREVIATIONS</b> .....	<b>vi</b>
<b>TERMINOLOGY</b> .....	<b>vii</b>
<b>1 INTRODUCTION</b> .....	<b>1</b>
<b>2 EPWP UNIVERSAL PRINCIPLES</b> .....	<b>2</b>
2.1 Workers Are Recruited Through a Fair and Transparent Process .....	2
2.2 Adherence to the Minimum Wage .....	2
2.3 Work provides or enhances public goods or community services.....	2
2.4 Compliance with minimum labour-intensity appropriate to Sector.....	2
<b>3 EPWP CROSS CUTTING ISSUES</b> .....	<b>3</b>
3.1 Convergence .....	3
3.2 Sustainable Livelihoods .....	3
3.3 Green Jobs .....	4
<b>4 RESPONSIBILITIES OF THE PUBLIC BODY</b> .....	<b>5</b>
4.1 Selection of projects.....	5
4.2 Large Projects.....	5
4.3 Setting of rate of pay .....	5
4.4 Appointment of consulting engineers/ project managers and contractors .....	6
4.5 Participants' Training.....	6
4.6 Monitoring and Reporting.....	6
<b>5 CONTRACT DOCUMENTATION FOR CONSULTING ENGINEERS/ PROJECT MANAGERS AND CONTRACTORS FOR LABOUR-INTENSIVE CONSTRUCTION/MAINTENANCE PROJECTS</b> .....	<b>7</b>



5.1	General.....	7
5.2	Documentation for Professional Services Contracts.....	7
5.3	Contract Documentation for the Works .....	9
5.3.1	<i>Notice and Invitation to tender / Conditions of tender</i> .....	9
5.3.2	<i>Contract Data</i> .....	9
5.3.3	<i>Scope of work</i> .....	10
5.4	Labour Issues .....	11
5.4.1	<i>Requirements for the sourcing and engagement of labour</i> .....	11
5.4.2	<i>Training of targeted labour</i> .....	11
5.5	Generic Labour-Intensive Specification.....	11
5.6	Bill of Quantities.....	15
<b>6</b>	<b>PLANNING AND IMPLEMENTATION CHECKLIST .....</b>	<b>16</b>
6.1	Design of Labour Intensive Works.....	16
6.2	Task Work and Inclement Weather .....	17
<b>7</b>	<b>REPORTING .....</b>	<b>17</b>
<b>8</b>	<b>APPENDIX A: SOURCES OF ADDITIONAL INFORMATION.....</b>	<b>18</b>
<b>9</b>	<b>APPENDIX B: TYPES OF INFRASTRUCTURE WHICH ARE SUITABLE FOR CONSTRUCTION/MAINTENANCE USING LABOUR-INTENSIVE METHODS.....</b>	<b>22</b>
<b>10</b>	<b>APPENDIX C: REQUIRED SKILLS PROGRAMMMES.....</b>	<b>25</b>
<b>11</b>	<b>APPENDIX D: PROGRAMME INDICATORS AND MINIMUM LABOUR INTENSITY TARGETS .....</b>	<b>27</b>
<b>12</b>	<b>APPENDIX E: CONSULTANT’S COMPLIANCE DECLARATION.....</b>	<b>32</b>
<b>13</b>	<b>APPENDIX F.1: IMPLEMENTING PUBLIC BODY MONITORING COMPLIANCE TEMPLATE .....</b>	<b>35</b>
<b>14</b>	<b>APPENDIX G: TASK RATES .....</b>	<b>38</b>
<b>15</b>	<b>APPENDIX H: EPWP REPORTING FORMS.....</b>	<b>46</b>
<b>16</b>	<b>APPENDIX I: EPWP BRANDING FORMAT .....</b>	<b>65</b>
<b>17</b>	<b>APPENDIX J: MINISTERIAL DETERMINATION FOR EPWP 2012 .....</b>	<b>67</b>

## ***FOREWORD***

The Expanded Public Works Programme (EPWP) is one of government's medium-to-long term programmes aimed at alleviating poverty and reducing unemployment. The EPWP will achieve this aim through the provision of work opportunities coupled with project based training. It is a national programme covering all spheres of government and state-owned enterprises (SOE's). The programme spans four Sectors comprising Infrastructure, Social, Non-State and Environment and Culture.

Government's medium-to-long term programmes to address unemployment include increasing economic growth, improving skills levels through education and training, and improving the enabling environment for industry to flourish. The EPWP will continue to exist until these medium-to-long term programmes are successful in reducing unemployment.

The programme involves the use of line function budgets so that government expenditure results in more work opportunities, particularly for unskilled labour. EPWP projects will therefore, be funded through the normal budgetary process, through the budgets of line-function departments, provinces and municipalities. The National Department of Public Works (NDPW) has the mandate for overall coordination of the programme.

Opportunities for implementing the EPWP have been identified in the Infrastructure; Environment and Culture; Social and Non State Sectors. In the Infrastructure sector the emphasis is on optimising the creation of work opportunities through the use of labour-intensive construction and maintenance methods. Labour-intensive construction methods involve the use of an appropriate mix of labour and machines, with a preference for labour where technically feasible and economically viable, without compromising the quality of the product.

All public bodies involved in infrastructure provision are expected to contribute to the programme. As part of this initiative, the national government has through the Division of Revenue Act (DORA) placed additional conditionalities on infrastructure grants. The grants call for increased focus in the cost efficient use of labour absorptive methodologies in the provision of infrastructure. These additional conditionalities require provinces and municipalities to use the "Guidelines for the implementation of labour-intensive infrastructure projects under the EPWP" for identification, design, construction and maintenance of assets. This document contains those guidelines.

International and local experience has shown that, with well-trained supervisory staff and an appropriate employment framework, labour-intensive methods can be used successfully for infrastructure projects such as those involving roads, sidewalks, stormwater drains, trenches, buildings, water and sanitation. On the basis of this experience, and in the context of high levels of unemployment, the national government has directed that these infrastructure projects must contribute to employment creation.

These guidelines aim to provide Government and its partners implementing Infrastructure Sector programmes/projects with the necessary tools to successfully implement these projects using Labour-Intensive Construction and Maintenance methods. These guidelines have been designed with the aim of minimising the additional work required from provincial and municipal officials. The National Department of Public Works is partnering with public and private institutions to develop the capacity of the construction industry to design and manage labour-intensive infrastructure projects successfully.

## ***PREFACE***

The guidelines contain sections which should be adapted into the relevant parts of the contract documentation for consulting engineers and contractors, based on the specific need. These sections introduce a requirement that certain construction and maintenance activities must be carried out by hand. Furthermore, client public bodies must ensure that both consultants and contractors comply with EPWP reporting frameworks. These requirements were formulated on the basis of a review of international and local experience of labour-intensive construction and maintenance, in order to identify the activities for which it is technically feasible and economically viable to use labour-intensive methods. The guidelines therefore conform to the Public Finance Management Act requirement for assessing the cost-effectiveness of capital projects. The normal tender evaluation processes should be followed when using guidelines, and it is not necessary to apply any special additional preferences for employment creation.

The guidelines include the contents of the Code of Good Practice for the Expanded Public Works Programme, which has been gazetted by the Department of Labour, and which provides for special conditions of employment for these EPWP projects.

In terms of the Code of Good Practice for the Expanded Public Works Programme, training is regarded as an important component of the EPWP. Each project should have a clear training programme for its workers to improve their work performance. Training will focus on needs and will be implemented based on a programme by programme basis.

In order to develop the capacity of the construction industry to manage labour-intensive projects, these guidelines also include an eligibility requirement for the appointment of contractors and consulting engineers, i.e. that all key staff involved in the project must undergo special NQF-accredited training programmes in labour-intensive construction at all levels.

As an additional means of addressing the capacity in the labour-intensive construction sector, NDPW together with the CETA has established a labour-intensive contractor learnership programme called the Vuk'uphile Contractor Learnership Programme. The aim of this learnership programme is to develop emerging contractors to execute work in accordance with these guidelines. As part of this learnership programme, learner contractors need to execute projects to gain practical experience under the guidance of a mentor. Partnering provinces and municipalities should allocate projects identified and designed using these guidelines to the learner contractors on a negotiated price basis in accordance with Treasury Learnerships waiver letter (obtainable from [www.epwp.gov.za](http://www.epwp.gov.za)) from open competitive tendering of learnership projects.

Whereas during Phase 1 of the EPWP the main parameter for measuring the employment created was work opportunities, in Phase 2 another parameter, Full Time Equivalent (FTE) employment was added. FTE refers to employment that is equivalent to employing one person for one year of 230 effective working days. Employment targets were also set for government bodies based on allocated grants. Another feature that was introduced in Phase 2 of the EPWP is the Incentive Grant. This is intended to incentivise public bodies to perform beyond their EPWP targets. In EPWP Phase 3 the reporting on labour intensity (expenditure on wages expressed as a percentage of total expenditure) and quantity and impact of assets created has been introduced and is measured in accordance with the EPWP Monitoring and Evaluation (M & E) Framework.

The latest electronic version of these guidelines and electronic copies of the following documents can be downloaded from [www.epwp.gov.za](http://www.epwp.gov.za):

- Code of Good Practice for Employment and Conditions of Work for the Expanded Public Works Programme.
- Ministerial Determination for the Expanded Public Works Programmes issued by the Minister of Labour.
- EPWP conditions as gazetted in the Division of Revenue Act (DORA).

### ***Amendments to the Second Edition incorporated in this Third Edition***

Amendments to the text of the second edition have been made to:

- i. align the text to developments and changes to EPWP policy and institutional arrangements;
- ii. align the text with the requirements of the Construction Industry Development Regulations;
- iii. delete text that has now become redundant; and
- iv. update applicable labour conditions to EPWP workers as per the latest Ministerial Determination for EPWP.

## ***ABBREVIATIONS***

<b>CETA:</b>	Construction Education and Training Authority
<b>CIDB:</b>	Construction Industry Development Board
<b>DOL:</b>	Department of Labour
<b>ECSA:</b>	Engineering Council of South Africa
<b>EPWP:</b>	Expanded Public Works Programme
<b>FIDIC:</b>	French acronym for the International Federation of Consulting Engineers
<b>FTE:</b>	Full Time Equivalent
<b>GCC:</b>	General Conditions of Contract
<b>JBCC:</b>	Joint Building Contracts Committee
<b>LI:</b>	Labour Intensity
<b>M &amp; E:</b>	Monitoring and Evaluation
<b>MIS:</b>	Management Information System
<b>NDPW:</b>	National Department of Public Works
<b>NEC:</b>	New Engineering Contract
<b>NQF:</b>	National Qualifications Framework
<b>QCTO:</b>	Quality Council for Trades and Occupations
<b>SANS:</b>	South African National Standard
<b>WO:</b>	Work Opportunities

## TERMINOLOGY

**Actual Expenditure:** the expenditure on activities implemented labour-intensively on the project by the contractor added to the expenditure by the professional service provider appointed to design and supervise the project. The actual expenditure excludes expenditure on government management and administration.

**Actual Labour Intensity:** Actual labour intensity = actual expenditure on wages expressed as a percentage of the total actual expenditure on activities implemented labour-intensively

**Actual Output:** achieved physical quantities (e.g. km or road, pipeline) corresponding to the actual expenditure.

**By hand:** refers to the use of tools which are manually operated and powered.

**Convergence:** is the fostering of synergies within and amongst sectors and programmes of the Expanded Public Works Programme (EPWP) to ensure that resources are efficiently and effectively utilised to optimise benefits for sectors, programmes, and participants.

**Daywork:** is work done that is paid on a daily basis in situations where it is impossible to estimate the quantity of the required input in advance. It is usually applied in situations where the quantitative measurement or setting of task including pricing is not possible.

### Demographic Characteristics of Workers

The number of workers that fall within the following categories must be recorded:

	Demographic	EPWP Target
	Youth (i.e. 16 – 35 years of age)	55%
	Women	55%
	People with Disabilities	2%

**EPWP Integrated Grant:** refers to funds payable to public bodies through a conditional grant to incentivise employment creation under the EPWP.

**EPWP Project:** refers to a project that incorporates the following elements to the extent possible: employment creation, labour-intensive methods, local resource optimisation (only use equipment for activities that cannot be effectively done by the use of labour), quality is not compromised, skills development and transfer, community ownership, optimisation of quality cost and time, decent working conditions (fair wages, appropriate provision for safety and health and freedom of association) and lays the foundation for sustainability.

**EPWP Target:** refers to a target set by the National Department of Public Works specifying the number of work opportunities and FTEs that a public body should endeavour to create

**Expanded Public Works Programme (EPWP):** refers to a programme to provide public or community assets or services through labour-intensive approach(ies) initiated by government and funded from public resources.

**Form of contract:** refers to a document (conditions of contract) published by industry which establishes the rights, liabilities and obligations of the contracting parties and the procedures for the administration of the contract.

**Full Time Equivalent (FTE) Employment Created:** refers to one person-year of employment. One person year is equivalent to 230 person days of work. The 230 days are effective days of work after subtracting provision for non-productive days in a year (e.g. leave, holidays, etc.).

1 FTE = person days divided by 230.

**Gravel:** is defined (according to soil classification) as a mixture of stones (2-60mm), sand, and clay which is composed of unconsolidated rock fragments.

**Green Jobs:** are understood as “green” when they help reduce negative environmental impact, ultimately leading to environmentally, economically and socially sustainable enterprises and economies. Green jobs are also decent (ILO, 2015) jobs that provide adequate incomes, social protection and ensure the respect for the rights of workers. Green jobs can cover a variety of employment ranging from jobs that improve energy and raw materials efficiency, limit greenhouse gas emissions, minimize waste and pollution, protect and restore ecosystems, and support adaptation to the effects of climate change.

**Group task:** is a work method whereby tasks are organised on the basis of many people completing one task (to produce a defined output in a day).

**Identity Documents:** refers to South African identity registration document.

**Labour-Intensity:** refers to the expenditure on wages expressed as a percentage of the total expenditure on activities implemented labour-intensively.

**Labour-intensive:** refers to methods of construction and maintenance involving a mix of labour and machines without compromising on quality, where labour is the primary resource supported by plant and equipment for activities that cannot be feasibly done by labour only.

**Large Project:** is an infrastructure project with a value of more than R 30 million (including VAT) that involves the use of labour-intensive methods on a significant scope of the works to maximise the creation of work opportunities.

**Learnership:** is a structured learning programme which involves theory, practical and workplace learning and leads to a registered qualification on the National Qualifications Framework (NQF).

**Ministerial Determination:** refers to a determination issued by the Minister of Labour in terms of the Basic Conditions of Employment Act of 1997. It applies to Expanded Public Works Programmes. The Ministerial Determination must be read in conjunction with the Code of Good Practice for the Expanded Public Works Programme.

**Person-days of Employment Created:** refers to the number of people who worked on a project multiplied by the number of days each person worked.

**Planned Labour Intensity:** is the planned wages budget expressed as a percentage of the total planned budget for activities to be implemented labour-intensively.

**Planned Output:** refers to planned physical quantities (e.g. km or road, pipeline) corresponding to the planned budget.

**Public body:** refers to a department, state owned entity, constitutional institution, municipality, public entity or municipal entity.

**Project Budget:** refers to the planned budget on activities to be implemented labour-intensively + the professional fees for the professional service provider appointed to design and supervise the project. The project budget excludes government management & administration costs.

**Project Wage Rate:** is the daily wage (whether task-rated or time-rated) per individual. This wage rate must be inserted in the Project tender document as per the EPWP Guidelines.

**Task:** refers to the amount of work to be performed to a defined quantity and quality.

**Task rate:** refers to the amount of work to be performed by a worker to a defined quantity and quality and be completed in a working day.

**Training Person-Days:** is the number of people who attended training x the number of days of training per person.

Training should be reported as follows;

1. Number of people trained
2. Number of people that received accredited training
3. Number of people that received non-accredited training
4. Profile of the participants (Women, Disabled, Youth)
5. Percentage of participants who worked on the project after receiving training.

**Scope of work:** refers to a specification and description of the services or construction/maintenance works which are to be provided and any other requirements and constraints relating to the manner in which the contract is to be performed.

**Semi-skilled work:** refers to work requiring a person to have some degree of training or familiarisation with the task to be performed before being able to operate at optimal efficiency.

**Sustainable Livelihoods:** a livelihood comprises the capabilities, assets (including both material and social resources) and activities required for a means of living. A livelihood is sustainable when it can cope with and recover from the stresses and shocks and maintain or enhance its capabilities and assets both now and in the future without undermining the natural resource base. It is not just about the means to survive, but the capability to thrive.

**Unskilled work:** refers to work that does not require a person to have received prior training related to the task to be performed and being able to operate to a satisfactory standard.

**Wage Rate:** refers to the set wage (whether task-rated or time-rated) to be paid to a worker who completes assigned work for the day.

**Work Opportunity:** refers to paid work created for an individual on an EPWP project for any period of time, within the employment conditions of the Code of Good Practice for the Expanded Public Works Programme. Learnerships will also constitute work opportunities. The same individual can be employed at different times on different projects (not concurrently) and each period of employment will be counted as a work opportunity.





# 1 INTRODUCTION

The objectives of implementing labour-intensive infrastructure projects under the EPWP include:

- providing employment opportunities and distribution of income through injecting some project funds into the local economy in the form of wages to local poor and unemployed people;
- providing training or skills development to locally employed workers;
- building cost-effective and quality assets.
- development of labour-intensive capacity in the construction industry.

This document is a guiding framework for the implementation of labour-intensive projects under the Expanded Public Works Programme. It provides the means by which labour-intensive works can be implemented under the most commonly encountered delivery model, namely design by employer (i.e. the model in which the contractor undertakes construction and maintenance on the basis of full designs issued by the employer.) It also assumes that the public body will appoint a consultant to design the works and to administer the contract. Local customisation of some elements of these guidelines will be necessary to accommodate other delivery models. Where no consultants are appointed, the staff of the public body needs to perform the activities assigned to consultants in this document.

The document in addition provides guidance on the:

- identification of suitable projects;
- appropriate design for labour-intensive construction/maintenance;
- specification of labour-intensive works; and
- compilation of contract documentation for labour-intensive projects.

Specific direction is given regarding contract clauses which must be included to amend or augment standard documentation, in order to implement labour-intensive projects.

These guidelines must be applied to all projects that are implemented under the EPWP. Appendix A provides sources of additional information.

The employment of locally recruited temporary workers on all EPWP labour-intensive infrastructure projects must be in accordance with the current Code of Good Practice for Employment and Conditions of Work for the Expanded Public Works Programme; issued in terms of the Basic Conditions of Employment Act, 1997 (Act No 75 of 1997) and promulgated in the Government Gazette. Extracts of this Code have been included in this Guidelines document. However, reference should be made to the full text of the latest versions of the Code of Good Practice and the related Ministerial Determination.

## **2 EPWP UNIVERSAL PRINCIPLES**

Effective from 1 April 2014 the EPWP adopted four universal principles to guide the implementation of the programme. This is not an exhaustive list, but lays fundamental requirements that every EPWP project is expected to comply with. The M&E framework provides details on mechanisms to respond to non-compliance.

### **2.1 Workers Are Recruited Through a Fair and Transparent Process**

The selection of each worker must be done based on a clear set of criteria and should follow a fair and transparent process to minimize patronage and abuse. The criteria for selection of participants in EPWP Phase 3 are that they:

1. Are willing and able to take up the offered work,
2. Can be categorised as poor,
3. Are unemployed or underemployed, and
4. Live close to the project area (i.e. local).

### **2.2 Adherence to the Minimum Wage**

This principle calls for adherence to the EPWP Minimum wage and employment conditions under the EPWP Ministerial Determination. The EPWP Ministerial Determination, as revised from time to time, sets out a minimum wage and minimum conditions of employment for the EPWP and implementers must comply with its requirements. All EPWP Coordinating structures will collaborate with the DOL in monitoring compliance by implementers.

### **2.3 Work provides or enhances public goods or community services**

The work output of each EPWP project should contribute to enhancing public goods or community services. A record of outputs forms part of reporting for all EPWP Phase 3 projects and programmes. All projects and programmes must measure and report the productivity and outputs of all work to achieve meaningful impact and ensure the state receives value for money. The M&E framework provides details of sector specific output indicators to be reported.

### **2.4 Compliance with minimum labour-intensity appropriate to Sector**

A minimum labour-intensity benchmark appropriate to each sector has been set. Furthermore, programmes within each EPWP Sector have their own minimum labour intensity threshold. It cannot be over-emphasised that the minimum labour intensity is not the default target that should be achieved, but the lowest threshold, above which the target must be set. There is no maximum labour intensity defined as this will be dictated by the type and nature of the project. However, in any case labour intensity cannot exceed 100%.

Projects that do not comply with this standard will be supported to increase their labour intensity. However, if they still fail to achieve their minimum labour intensity they shall be excluded from the final report. Appendix D provides details of minimum labour intensity thresholds for each sector and their programmes.

## 3 EPWP CROSS CUTTING ISSUES

### 3.1 Convergence

More emphasis will be placed on convergence between sectors in the implementation of EPWP Phase 3.

The rationale for Convergence is that;

- It will build synergies within EPWP.
- It will reduce duplication and overlap of programmes.
- Convergence will reduce potential for duplicate reporting of the same work opportunities.
- Maximum benefits will be achieved in the implementation of projects through alignment of sectors and programmes within sectors.

Areas of Convergence in EPWP include the following;

- Recruitment and selection – in accordance with the standard EPWP recruitment procedures;
- Payment of stipends and wages - all sectors to pay at least the EPWP minimum wage;
- Convergence between and amongst sectors – e.g. joint planning and pooling of resources;
- Convergence between and amongst programmes within the same sector e.g. uniform norms and standards; and
- Business process convergence – e.g. planning, financing, reporting, branding.

### 3.2 Sustainable Livelihoods

In EPWP, Sustainable Livelihoods are supported both during participation in the programme and post participation. EPWP participants receive income to sustain themselves and their dependants. Furthermore, skills acquired from the programme can be used for future employability and/or entrepreneurship initiatives.

Infrastructure is one of the core elements of sustainable livelihoods, both during the construction and maintenance phases of the assets. It consists of changes to the physical environment that help people to meet their basic needs and to be more productive. EPWP promotion of the following components of infrastructure are essential for sustainable livelihoods:

Secure shelter and buildings;

Adequate water supply and sanitation;

Clean, affordable energy;

Access to information (communications); and

Affordable transport.

### 3.3 Green Jobs

Green Jobs can be created through a deliberate choice of materials, processes and work methods that rely mainly on renewable sources.

The following are examples of infrastructure related elements that can create Green Jobs.

#### **Green Buildings**

- Retro fitting using Green materials
- Thermal Insulation to reduce energy demand
- Solar energy system
- Rain water harvesting and storage
- Water saving devices

#### **Roads Infrastructure (Construction & Maintenance)**

- Drainage structures and protection works using natural and locally-based resources
- Appropriate choice of technology and construction materials
- Non-motorised transport infrastructure e.g. Sidewalks and cycle lanes

#### **Water**

- Stormwater management infrastructure
- Irrigation infrastructure
- Water harvesting infrastructure

#### **Energy**

- Renewable energy e.g. Solar, wind, wave, hydro
- Efficient lighting (new construction and retrofitting)

#### **Erosion Protection**

- Slope Protection e.g. Grassing
- Gully Protection e.g. Use of local rock materials
- Construction of Gabions

#### **Waste Management**

- Recycling Infrastructure

## 4 RESPONSIBILITIES OF THE PUBLIC BODY

### 4.1 Selection of projects

The public body must implement EPWP projects not limited to the following types of infrastructure labour-intensively, in accordance with these guidelines (see Appendix B):

- roads
- sidewalks and non-motorised transport infrastructure
- stormwater drainage;
- water and sanitation
- buildings
- landscaping; and
- electricity

Where such projects contain a significant amount of the construction/maintenance activities for which the use of labour is specified, the Generic Labour-Intensive Specification in section 5.5 should be applied, i.e. excavation, loading, short-distance hauling, offloading, spreading, grassing, and stone-pitching.

The public body must be satisfied that sufficient local labour (willing to work) is available for the project, before proceeding with the project as a labour-intensive project.

The public body is expected to send its relevant managers on the applicable skills programmes in labour-intensive construction (See Appendix C).

### 4.2 Large Projects

A Large Project is an infrastructure project with a value of more than R 30 million (including VAT) that involves the use of labour-intensive methods on a significant scope of work to maximise the creation of work opportunities. Large projects can be singular or aggregation of smaller projects, culminating in a monetary value of at least R 30 million. For singular large projects, only the scope of works that can be implemented labour-intensively is reported under the EPWP. For aggregated large projects, the entire scope is considered to be amenable to use of labour-intensive methods. Large Projects should be designed and packaged to promote participation of small to medium term contractors.

### 4.3 Setting of rate of pay

In accordance with the Code of Good Practice for Employment and Conditions of Work for the Expanded Public Works Programme, the public body must set a rate of pay (not less than the minimum EPWP rate as stipulated in the Ministerial Determination) for workers to be employed on EPWP projects.

The following principles should be considered when setting rates of pay for workers:

- The rate set should take into account wages paid for comparable unskilled work in the local area per sector, if necessary.*
- The rate should be an appropriate wage to offer an incentive for work, to reward effort provided and to ensure the desired quality of work. It should not be more than the average local rate to ensure people are not recruited away from other employment and jobs with longer-term prospects.*

- *Men, women, disabled persons and the aged must receive the same pay for work of equal value.*

The minimum wage is reviewed annually effective 1<sup>st</sup> November of each year. The review is based on the inflation and the new wage rate is announced six weeks before it becomes effective.

As per the Code of Good Practice for Employment and Conditions of Work for the Expanded Public Works Programme, task rates are applicable with recommended rates as shown in Appendix G.

#### **4.4 Appointment of consulting engineers/ project managers and contractors**

The public body must ensure that:

- i) the design of the labour-intensive works by consultants is overseen by persons in their employ who have completed the necessary skills training (see Appendix C);
- ii) works contracts are administered by persons in the employ of consultants who have completed the necessary skills training (see Appendix C); and
- iii) works contracts are awarded to contractors who have in their employ managers who have completed the necessary skills training (see Appendix C).
- iv) consultants are expected to sign an undertaking confirming they have complied with EPWP requirements at design and implementation stages. A sample is provided in (Appendix E).

Ideally, everyone involved in the implementation of EPWP projects should be competent in labour-intensive methods of construction and/or maintenance as necessary.

#### **4.5 Participants' Training**

Public bodies should ensure that participants employed on their EPWP projects receive accredited training whenever possible. This may be done through submission of training applications to the relevant Regional Office of the Department of Higher Education and Training. Personnel from the National Department of Public Works or Provincial Coordinating Department EPWP units will assist the Public Body to prepare and submit the training applications to relevant Provincial office of the Department of Higher Education and Training or to any other funders like SETAs.

#### **4.6 Monitoring and Reporting**

Public bodies must ensure effective monitoring of the labour-intensive activities and reporting of EPWP projects on the EPWP reporting system. For effective project monitoring, the Compliance Checklist provided in Appendix F is recommended for use by Public Bodies.

## 5 CONTRACT DOCUMENTATION FOR CONSULTING ENGINEERS/PROJECT MANAGERS AND CONTRACTORS FOR LABOUR-INTENSIVE CONSTRUCTION/MAINTENANCE PROJECTS

### 5.1 General

All the standard forms of contract listed in the CIDB Standard for Uniformity in Construction Procurement may be used for labour-intensive projects. It is not necessary to create new forms of contract or to amend the approved forms of contract to implement labour based works.

Requirements for labour-intensive works need to be established in the scope of works, special conditions of contract and specifications associated with contract documentation.

The approved standard forms of contract for professional services use different terms to describe the parties to the contract. These guidelines use the terms employer and consultant for the parties engaged in professional service contracts and scope of work for requirements in both professional service and construction/maintenance contracts.

### 5.2 Documentation for Professional Services Contracts

The scope of work must establish the manner in which the consultant is to provide the Professional services associated with labour-intensive works.

All services relating to the implementation of the works which are to be provided in terms of these Guidelines are normal services in terms of the Guideline Scope of Service and Tariff of Fees for Persons Registered in terms of the various Built Environment Professions Acts. Any changes in the design of the works to incorporate labour-intensive works should not constitute a change in scope or an additional service where the scope of work is framed around such publications.

**The following must be included in the scope of works in the contract of employment with a Professional services Consultant:**

#### **Labour-intensive works**

1. The Consultant shall not perform any significant portion of a project involving labour-intensive works under the direction of a staff member who has not completed the NQF level 7 unit standard "Develop and Promote Labour-Intensive Construction Strategies" or equivalent QCTO qualifications (See Appendix C).
2. The staff member of the consultant who is responsible for the administration of any works contract involving labour-intensive works must have completed the NQF level 5 unit standard "Manage Labour-Intensive Construction Projects" or equivalent QCTO qualifications (See Appendix C).

The Consultant must provide the Employer with satisfactory evidence (e.g. letter of competency) that staff members satisfy the requirements of 1 and 2.

3. The Consultant must design and implement the construction/maintenance works in accordance with the latest version (download at [www.epwp.gov.za](http://www.epwp.gov.za)) of Guidelines for the Implementation of the Labour-Intensive Projects under the Expanded Public Works Programme (these Guidelines) published by the National Department of Public Works. The Consultant must sign the undertaking (Appendix E) confirming they have complied with EPWP requirements at design and implementation stages.



4. The Consultant shall, for monitoring purposes, keep monthly records and transmit to the Client data on the following indicators with regard to the EPWP projects implemented:
- Project budget and planned output according to EPWP requirements
  - Actual Project Expenditure and actual output according to EPWP requirements
  - Planned and achieved labour intensity
  - Number of work opportunities created
  - Demographics of workers employed (disaggregated by women, youth and persons with disabilities)
  - Wage rate earned on project
  - Number of person-days of employment created
  - Copies of Identity documents of workers
  - Number of persons who have attended training including the nature and duration of training provided
  - Assets created, rehabilitated or maintained in accordance with indicators in the EPWP M & E Framework
  - Services provided or delivered in accordance with indicators in the EPWP M & E Framework
5. The values for the indicators shall be submitted to the Employer according to agreed time frames on the prescribed reporting template (from the EPWP Unit in the DPW) and obtainable from [www.epwp.gov.za](http://www.epwp.gov.za).
6. The Consultant shall, before certifying a contractor's payment certificate, ensure that the contractor has submitted labour information in a format and timeframe specified by the employer. If the information submitted by the contractor is inadequate the consultant shall not submit the payment certificate to the employer for payment of the relevant outputs.
7. The Consultant shall certify that the works have been completed in accordance with the requirements of the Guidelines and the Contract:
- a) whenever a payment certificate is presented to the Employer for payment; and
  - b) immediately after the issuing of a practical completion certificate that signifies that the whole of the works have reached a state of readiness for occupation or use for the purposes intended although some minor work may be outstanding.

## 5.3 Contract Documentation for the Works

Applicable standard contract documents will apply incorporating specific EPWP/LIC conditions and specifications as outlined below.

EPWP documents and projects should be branded in accordance with the latest Corporate Identity Manual obtainable from [www.epwp.gov.za](http://www.epwp.gov.za)

### 5.3.1 Notice and Invitation to tender / Conditions of tender

Public bodies must only award contracts to contractors who have demonstrated that they will have in their employ (if awarded the contract) suitably qualified senior and middle supervisory staff to supervise the labour-intensive works during the validity of the contract. Tenderers must be made aware of this requirement in tender documents. Those responsible for evaluating tenders must confirm that the contractor has signed agreements with such staff during the tender evaluation process.

The following must be included in the notice and invitation to tender:

*“Only tenderers who can demonstrate that they will have in their employ staff which satisfy EPWP requirements during the contract validity are eligible to submit tenders”.*

**The following must be included in the tender data in accordance with the provisions of the CIDB Standard for Uniformity in Construction Procurement:**

F.2.1	Only those tenderers who <i>can demonstrate that they will</i> have in their employ management and supervisory staff satisfying the requirements of the scope of work for labour-intensive competencies for supervisory and management staff <i>during the validity of the contract</i> are eligible to submit tenders.
F.2.18	The tenderer must submit to the Employer, names of all management and supervisory staff that will be employed to supervise the labour-intensive portion of the works together with satisfactory evidence that such staff members satisfy the eligibility requirements.

### 5.3.2 Contract Data

The following must be included in the contract data in the contract with the Employer:

#### **Payment for the labour-intensive component of the works**

Payment for works identified in the Scope of Work as being labour-intensive shall only be made in accordance with the provisions of the Contract if the works are constructed strictly in accordance with the provisions of the Scope of Work. Any non-payment for such works shall not relieve the Contractor in any way from his obligations either in contract or in delict.

#### **Linkage of payment for labour-intensive component of works to submission of project data**

The Contractor's payment invoices shall be accompanied by labour information for the corresponding period in a format specified by the employer. If the contractor chooses to delay submitting payment invoices, labour returns shall still be submitted as per frequency and timeframe stipulated by the Employer. The contractor's invoices shall not be paid until all pending labour information has been submitted.

## **Applicable labour laws**

The current Ministerial Determination (also downloadable at [www.epwp.gov.za](http://www.epwp.gov.za)), Expanded Public Works Programmes, issued in terms of the Basic Conditions of Employment Act of 1997 by the Minister of Labour in Government Notice , shall apply to works described in the scope of work as being labour-intensive and which are undertaken by unskilled or semi-skilled workers.

### ***5.3.3 Scope of work***

Applicable Standard specifications are to be utilised. It is necessary, however, to include certain requirements (special specifications) in the scope of works to implement labour-intensive works in accordance with the provisions of these Guidelines.

The following wording, as appropriate, must be included in the scope of work in the contract with the contractor.

## **DESCRIPTION OF THE WORKS**

### **1. Employer's objectives**

The employer's objectives are to deliver public infrastructure using labour-intensive methods in accordance with EPWP Guidelines.

### **2. Labour-intensive works**

Labour-intensive works shall be constructed/maintained using local workers who are temporarily employed in terms of the scope of work.

### **3. Labour-intensive competencies of supervisory and management staff**

Contractors shall only engage supervisory and management staff in labour-intensive works that have completed the skills programme including Foremen/ Supervisors at NQF level 4 "National Certificate: Supervision of Civil Engineering Construction Processes" and Site Agent/ Manager at NQF level 5 "Manage Labour-Intensive Construction Processes" or equivalent QCTO qualifications (See Appendix C) at NQF outlined in Table 1.

## 5.4 Labour Issues

In the following sections are some of the considerations that are elaborated in the Code of Good Practice for Expanded Public Works Programme:

### *5.4.1 Requirements for the sourcing and engagement of labour*

Unskilled and semi-skilled labour required for the execution of all labour-intensive works shall be engaged strictly in accordance with prevailing legislation, in accordance with the Code of Good Practice for the Expanded Public Works Programme and the EPWP Standard Recruitment Directives.

### *5.4.2 Training of targeted labour*

1. The contractor shall provide all the necessary on-the-job training to targeted labour to enable such labour to master the basic work techniques required to undertake the work in accordance with the requirements of the contract in a manner that does not compromise worker health and safety.
2. Accredited training should ideally be provided before commencement or during implementation of a project.
3. The cost of accredited training of targeted labour will be funded through various funding sources such as National Skills Fund from the Department of Higher Education and Training, funds from the Implementing Public body, funding from SETAS etc. This training should take place as close to the project site as practically possible. The Public Body implementing the project must ensure that training applications for participants are made by its relevant project manager assisted by relevant training officials from the National Department of Public Works.
4. The Public Body must ensure that preference of the training of participants in technical skills over life skills is made. In addition, the Public Body is required to maximize opportunities for training of participants carried out before the implementation of projects.
5. The Public Body must ensure that workers who have received training will be placed on the project to work after receiving the training.
6. If a provisional sum for training is made in the contract the contractor shall pay an allowance equal to 100% of the daily wage rate to workers who attend accredited training.

## 5.5 Generic Labour-Intensive Specification

**The Generic Labour-intensive specification below (informed by SANS 1921-5, Construction and management requirements for works contracts - Part 5: Earthworks) covers activities which are to be performed by hand, and should be included in the scope of works without amendment or modification as set out below.**

This specification establishes general requirements for activities which are to be executed by hand involving the following:

- trenches having a depth of less than 1.5 metres
- stormwater drainage
- roads
- sidewalks and non-motorised transport infrastructure
- water and sanitation

## **Precedence**

Where this specification is in conflict with any other standard or specification referred to in the Scope of Works to this Contract, the requirements of this specification shall prevail.

## **Hand excavateable material**

Hand excavateable material is:

### **a) granular materials:**

- i) whose consistency when profiled may in terms of table 2 be classified as very loose, loose, medium dense, or dense; or
- ii) where the material is a gravel having a maximum particle size of 10mm and contains no cobbles or isolated boulders, no more than 15 blows of a dynamic cone penetrometer is required to penetrate 100mm;

### **b) cohesive materials:**

- i) whose consistency when profiled may in terms of table 2 be classified as very soft, soft, firm, stiff and stiff / very stiff; or
- ii) where the material is a gravel having a maximum particle size of 10mm and contains no cobbles or isolated boulders, no more than 8 blows of a dynamic cone penetrometer is required to penetrate 100mm;

## **Note**

- 1) A boulder is material with a particle size greater than 200mm, a cobble and gravel is material between 60 and 200mm.
- 2) A dynamic cone penetrometer is an instrument used to measure the in-situ shear resistance of a soil comprising a drop weight of approximately 10 kg which falls through a height of 400mm and drives a cone having a maximum diameter of 20mm (cone angle of 60° with respect to the horizontal) into the material being used.

<b>Table 2: Consistency of materials when profiled</b>			
<b>GRANULAR MATERIALS</b>		<b>COHESIVE MATERIALS</b>	
<b>CONSISTENCY</b>	<b>DESCRIPTION</b>	<b>CONSISTENCY</b>	<b>DESCRIPTION</b>
Very loose	Crumbles very easily when scraped with a geological pick.	Very soft	Geological pick head can easily be pushed in as far as the shaft of the handle.
Loose	Small resistance to penetration by sharp end of a geological pick.	Soft	Easily dented by thumb; sharp end of a geological pick can be pushed in 30-40 mm; can be moulded by fingers with some pressure.
Medium dense	Considerable resistance to penetration by sharp end of a geological pick.	Firm	Indented by thumb with effort; sharp end of geological pick can be pushed in up to 10 mm; very difficult to mould with fingers; can just be penetrated with an ordinary hand spade.
Dense	Very high resistance to penetration by the sharp end of a geological pick; requires many blows for excavation.	Stiff	Can be indented by thumb-nail; slight indentation produced by pushing geological pick point into soil; cannot be moulded by fingers.
Very dense	High resistance to repeated blows of a geological pick.	Very stiff	Indented by thumb-nail with difficulty; slight indentation produced by blow of a geological pick point.

### **Trench excavation**

All hand excavateable material in trenches having a depth of less than 1,5 metres shall be excavated by hand.

### **Compaction of backfilling to trenches (areas not subject to traffic)**

Backfilling to trenches shall be placed in layers of thickness (before compaction) not exceeding 100mm. Each layer shall be compacted using hand stampers;

- a) to 90% Mod AASHTO;
- b) such that in excess of 5 blows of a dynamic cone penetrometer (DCP) is required to penetrate 100 mm of the backfill, provided that backfill does not comprise more than 10% gravel of size less than 10mm and contains no isolated boulders, or
- c) such that the density of the compacted trench backfill is not less than that of the surrounding undisturbed soil when tested comparatively with a DCP.

## **Excavation**

All excavateable material including topsoil classified as hand excavateable shall be excavated by hand. Harder material may be loosened by mechanical means prior to excavation by hand. Any material which presents the possibility of danger or injury to workers shall not be excavated by hand.

## **Clearing and grubbing**

Grass and bushes shall be cleared by hand.

## **Shaping**

All shaping shall be undertaken by hand.

## **Loading**

All loading shall be done by hand. Haulage equipment should be selected in a manner that allows loading by hand to the greatest extent possible.

## **Haul**

Excavation material shall be hauled to its point of placement by means of wheelbarrows where the haul distance is not greater than 150m.

## **Offloading**

All material, however transported, is to be off-loaded by hand, unless tipper-trucks are utilised for haulage.

## **Spreading**

All material shall be spread by hand.

## **Compaction**

Small areas may be compacted by hand provided that the specified compaction is achieved. Appropriate rollers should be used where higher (than can be achieved by hand) levels of compaction are required or for large areas.

## **Grassing**

All grassing shall be undertaken by sprigging, sodding, or seeding by hand.

## Stone pitching and rubble concrete masonry

All stone required for stone pitching and rubble concrete masonry, whether grouted or dry, must to be collected, loaded, off loaded and placed by hand.

Sand and stone shall be hauled to its point of placement by means of wheelbarrows where the haul distance is not greater than 150m.

Grout shall be mixed and placed by hand.

## Manufactured Elements

Elements manufactured or supplied by the Contractor, such as manhole rings and cover slabs, precast concrete planks and pipes, masonry units and edge beams shall not individually, have a mass of more than 320kg. Where the mass of an element exceeds 55 kg, consideration should be given to the size of the element relative to its total mass related to the number of workers who would be needed to lift such mass

## 5.6 Bill of Quantities

Labour-intensive works must be highlighted in the bills of quantities for the payment items relating to labour-intensive works. The following wording, as appropriate, should be included in the pricing Instructions and in the bills of quantities in the pricing data:

1. Those parts of the works to be constructed using labour-intensive methods should be marked in the bill of quantities with the letters LI either in a separate column or as a prefix or suffix against every item so designated (as illustrated in the table below). The works, or parts of the works so designated are to be constructed using labour-intensive methods only. The use of plant to provide such works, other than plant specifically provided for in the scope of work, is a deviation from the contract. The items marked with the letters LI are not necessarily an exhaustive list of all the activities which must be done by hand, and this clause does not over-ride any of the requirements in the generic labour-intensive specification in the Scope of Works.
2. Where minimum labour intensity is specified by the design the contractor is expected to use their initiative to identify additional activities that can be done labour-intensively in order to comply with the set minimum labour intensity target.
3. Payment for items which are designated to be constructed labour-intensively (either in this schedule or in the Scope of Works) will not be made unless they are constructed using labour-intensive methods. Any unauthorised use of plant to carry out work which was to be done labour-intensively will not be condoned and any works so constructed will not be certified for payment.



ITEM NO	DESCRIPTION	UNIT	QUANTITY	RATE	AMOUNT
33.07LI	Removal of unsuitable material (including free-haul to 0.5km)	m <sup>3</sup>			



## 6 PLANNING AND IMPLEMENTATION CHECKLIST

### 6.1 Design of Labour Intensive Works

**Cognisance of the following should be taken in the design of labour-intensive works:**

1. Project identification – Is the location of the project suitable for labour-intensive construction/maintenance methodology.
2. Earthworks must be designed taking consideration of the labour-intensive construction/maintenance methodology.
3. Vertical and horizontal alignment of the works (roads, trenches, pipelines and stormwater channels) should be such to optimise cut and fill, minimise deep or hard excavation or areas requiring specialist engineering input for example dewatering or specialist ground stabilisation.
4. During the design of gravel roads, suitable construction material should be sourced in close proximity to the site of the Works.
5. Drawings must be produced and presented in a clear easily understandable way. Where setting out information is provided in the form of coordinates it should be backed up with methods, not relying on sophisticated surveying instruments, such as offsets measurable with the use of a standard tape. Where possible, appropriate drawings should be produced using a background of ortho photos to provide for easy identification of surrounding features.
6. Is there sufficient resources within close proximity of the project – labour and material (within 150m to 5000m from project)?
7. Where the haul distance is greater than 150m, and less than 5000m the use of small volume local transport, should be considered.
8. Excavation in material which may constitute a safety hazard for workers should not be done using labour.
9. Is there any preliminary work required prior to labour-intensive construction/maintenance methods being implemented?
10. Is the design related and supportive of labour-intensive construction/maintenance methodology – such as appropriate information to facilitate manual setting out of the works or setting out information not reliant on sophisticated survey equipment.
11. All pre-manufactured materials which are incorporated into the Works must be sized such that the mass of individual elements does not exceed 320kg. Men should not lift individual loads exceeding 55kg and for women the limit is 35kg.
12. Are the materials required checked so that labour can easily work with them without unnecessary strain.
13. Stone masonry and grouted stone pitching should be included wherever suitable material is available and structurally suitable, to the exclusion of pre-cast or cast in situ concrete stormwater structures.
14. Where compaction of road layer works is required, it must be carried out using conventional compaction equipment (pedestrian rollers where possible). Compaction of small areas and in trenches may be carried out using hand stampers.
15. Consideration must be given to alternate design of gravity pipework to reduce depth of excavation.
16. Where there is an indication of local skills, e.g. bricklaying, structures should be designed to make use of such skills.
17. There are appropriate designs for labour-intensive construction/maintenance of low-cost surfacing for roads. Refer to Appendix A for further details.

18. Are the items of work on projects checked for labour-intensive construction and maintenance suitability?
19. Are there any statutory obligations required such as Environment Management Plans (EMP)?
20. Are the site safety conditions not compromised by suggested labour-intensive construction and maintenance methods and are the safety statutory requirements adequate for the number of labour employed?
21. Has the Contractor timely provided the workers with sufficient and good quality handtools?
22. Have procedures been streamlined to ensure prompt payments to the contractor, and workers respectively?
23. Are the supervisory staff suitably qualified?
24. Green Jobs - Principles of Green Jobs should be integrated in the design and implementation of various types of infrastructure. This includes materials and physical assets.
25. Is it possible to integrate elements of sustainable livelihoods.

## **6.2 Task Work and Inclement Weather**

If work is stopped due to inclement weather the following is recommended for the EPWP task rated workers;

1. If work is stopped and workers are released they shall be paid as if the day's task was completed.
2. If work is stopped temporarily and the site agent deems it possible to still complete the task on the same day the workers shall complete their task.
3. If the workers are informed not to come to work the following and/or subsequent days they shall not be paid for the days not worked.

## **7 REPORTING**

All EPWP projects have to be registered and progress reports submitted according to agreed formats and timeframes. Appendix H provides forms that are recommended for use by public bodies, consultants and contractors implementing the EPWP.

## 8 APPENDIX A: SOURCES OF ADDITIONAL INFORMATION

The following sources provide comprehensive information in respect of the following topics:

TOPIC	REFERENCE	OBTAINABLE FROM
Alternative building technologies referred by Agreement SA	<p>Agreement South Africa's Guideline 1, The Manufacture of BESA Blocks.</p> <p>Agreement Open Certificate OC-1/2003. Agreement Open Certificate OC-2/2003. CIDB. Best Practice Guidelines for Labour-based.</p> <p>Methods and Technologies for Employment Intensive Construction Works.</p> <p>Part 3: Section 2- The BESA Building System.</p>	<p>Agreement South Africa <a href="mailto:www.agreement@csir.co.za">www.agreement@csir.co.za</a></p> <p>Construction Industry Development Board <a href="http://www.cidb.org.za">www.cidb.org.za</a> under the section "job creation"</p>
Brick and block making	<p>CIDB. Best Practice Guidelines for Labour-based Methods and Technologies for Employment Intensive.</p> <p>Construction Works. Part 3: Section 1- Precast Concrete Products, Brick and Block Making.</p>	<p>Construction Industry Development Board <a href="http://www.cidb.org.za">www.cidb.org.za</a> under the section "job creation"</p>
Bituminous Surfacing	<p>Methods and Procedures for Labour Enhanced Construction for Bituminous surfacings Manual 12, 2011. SABITA.</p> <p>Methods and Procedures Labour Enhanced Construction for Bituminous surfacings Manual 11, March 1993. SABITA. Construction of Low Volume Sealed Roads; Good Practice Guide to Labour Based Methods, ILO A. Asare et. al. 2013.</p>	<p>Southern African Bitumen and Tar Association.</p> <p><a href="http://www.epwp.gov.za">www.epwp.gov.za</a></p>
Conditions of Employment	<p>Code of Code of Good Practice for Employment and Conditions of Work for EPWP.</p> <p>Ministerial Determination.</p>	<p>EPWP Branch of the Department of Public Works</p> <p><a href="http://www.epwp.gov.za">www.epwp.gov.za</a></p>
Concrete Block Paved Roads	<p>Publications by Cement and Concrete Institute.</p> <p>Development .Series, Number 8. Development Bank of Southern. Africa. September, 1993.</p>	<p>Development Bank of Southern Africa.</p>
Concrete roads	<p>Low-volume concrete roads by Bryan Perrie.</p>	<p>Cement and Concrete Institute</p> <p><a href="http://www.cnci.org.za">www.cnci.org.za</a></p>
Earthworks	<p>CIDB. Best Practice Guidelines for Labour-based Methods and Technologies for Employment Intensive Construction Works. (Download from <a href="http://www.cidb.org.za">www.cidb.org.za</a>).</p> <ul style="list-style-type: none"> <li>• Part 2: Labour-based construction methods for earth works.</li> <li>• Appendix 1: Quantitative Employment Data on Selected Construction Activities.</li> </ul>	<p>Construction Industry Development Board <a href="http://www.cidb.org.za">www.cidb.org.za</a> under the section "job creation"</p>

TOPIC	REFERENCE	OBTAINABLE FROM
Labour-intensive projects and programmes	<p>McCutcheon, RT (ed) (1993). Interim Guidelines for employment-intensive construction projects. Construction and Development Series Number 2.</p> <p>Midrand: Development Bank of Southern Africa, February 1993.</p> <p>McCutcheon, RT and Marshall J (1996). Labour-intensive Construction and Maintenance of Rural Roads : Guidelines for the Training of Road.</p> <p>Builders, Construction and Development Series, Number 14 (Midrand: DBSA, November 1996).</p> <p>McCutcheon, RT and Taylor Parkins, FLM (ed). Employment and high -standard infrastructure. Work Research Centre for Employment Creation in Construction (2003).</p>	<p>Development Bank of Southern Africa</p> <p>School of Civil Engineering, University of the Witwatersrand.</p>
Labour productivities	<p>CIDB. Best Practice Guidelines for Labour-based Methods and Technologies for Employment Intensive Construction Works.</p> <ul style="list-style-type: none"> <li>Appendix 1: Quantitative Employment Data on Selected Construction Activities.</li> </ul> <p>Technical Briefs on Task System, ILO.</p>	<p>Construction Industry Development Board (CIDB) website:</p> <p><a href="http://www.cidb.org.za">www.cidb.org.za</a> under the section “job creation”</p> <p><a href="http://www.epwp.gov.za">www.epwp.gov.za</a></p>
Minimum wages	<ul style="list-style-type: none"> <li>Wage determination for the Civil Engineering Sector.</li> <li>Ministerial Determination for EPWP.</li> </ul>	<p><a href="http://www.safcec.org.za">www.safcec.org.za</a> under the section “human resources”</p> <p>EPWP Unit of the Department of Public Works</p>
Monitoring the employment of workers / compliance with the provisions of SANS 1914-5	<p>SANS 10396, Implementing Preferential Procurement Policies Using Targeted Procurement Procedures.</p> <ul style="list-style-type: none"> <li>Annex G: Implementing employment intensive infrastructure projects which target the increase of employment opportunities generated per unit of expenditure.</li> <li>Annex J: Third party management support.</li> </ul>	<p>Standards South Africa (division of the South African Bureau of Standards)</p>
Pre-cast concrete works	<p>CIDB Best Practice Guidelines for Labour-based Methods and Technologies for Employment Intensive. Construction Works.</p> <ul style="list-style-type: none"> <li>Part 3: Section 1- Pre-cast Concrete Products, Brick and Block Making.</li> </ul>	<p>Construction Industry Development Board <a href="http://www.cidb.org.za">www.cidb.org.za</a> under the section “job creation”</p>
Preparing procurement documents	<p>CIDB Best Practice Guidelines for Procurement C1: Preparing Procurement Documents SANS 10403, Formatting and Compilation of Construction Procurement Documents.</p>	<p>Construction Industry Development Board <a href="http://www.cidb.org.za">www.cidb.org.za</a> under the section “job creation” Standards South Africa (division of the South African Bureau of Standards)</p>
Costing Labour Based Road Works	<p>Guidelines for Costing Labour Based Road Works. ILO. A. O. Asare, 2015.</p>	<p>EPWP website: <a href="http://www.epwp.gov.za">www.epwp.gov.za</a></p>

TOPIC	REFERENCE	OBTAINABLE FROM
Roads	<p>CIDB Best Practice Guidelines for Labour-based. Methods and Technologies for Employment Intensive Construction Works.</p> <ul style="list-style-type: none"> <li>• Part 2: Labour-based construction methods for earthworks.</li> <li>• Part 4: Section 4 - Foam bitumen gravel.</li> <li>• Part 4: Section 5 - Cast in-situ block pavements (hyson cells).</li> <li>• Part 4: Section 6 - Emulsion treated gravel.</li> <li>• Part 4: Section 7 - Waterbound macadam.</li> <li>• Part 4: Section 8 - Slurry bound and composite macadams</li> <li>• Part 4: Section 9 - Labour-based methods for unsealed roads.</li> <li>• Appendix 1: Quantitative Employment Data on Selected Construction Activities.</li> <li>• Construction of Low Volume Sealed Roads – Good Practice Guide to Labour-Based Methods, ILO A. Asare et. al. 2013.</li> </ul>	<p>Construction Industry Development Board (CIDB) website: <a href="http://www.cidb.org.za">www.cidb.org.za</a> under the section “job creation”</p> <p>EPWP Website: <a href="http://www.epwp.gov.za">www.epwp.gov.za</a></p>
Rubble concrete masonry	<p>CIDB Best Practice Guidelines for Labour-based. Methods and Technologies for Employment Intensive Construction Works.</p> <ul style="list-style-type: none"> <li>• Part 4: Section 2 – Rubble masonry dam construction technology.</li> <li>• Part 4: Section 3 – Rubble masonry concrete arch bridge construction technology.</li> </ul>	<p>Construction Industry Development Board <a href="http://www.cidb.org.za">www.cidb.org.za</a> under the section “job creation”</p>
Stormwater drainage	<p>CIDB Best Practice Guidelines for Labour-based Methods and Technologies for Employment Intensive Construction Works.</p> <ul style="list-style-type: none"> <li>• Part 4: Section 1 – Labour-based Open Channel Flow Technology.</li> </ul>	<p>Construction Industry Development Board <a href="http://www.cidb.org.za">www.cidb.org.za</a> under the section “job creation”</p>
Technical Briefs	<p>Principles for Project Cost Estimating, ILO.</p> <p>EPWP Infrastructure Project Cycle Management, ILO.</p> <p>Roles of Stakeholders During the Various Stages of the EPWP Project Cycle, ILO.</p> <p>EPWP Site Recording for Labour Intensive Projects, ILO.</p>	<p><a href="http://www.epwp.gov.za">www.epwp.gov.za</a></p>

TOPIC	REFERENCE	OBTAINABLE FROM
Trenches	<p>CIDB Best Practice Guidelines for Labour-based Methods and Technologies for Employment Intensive Construction Works. (Download from <a href="http://www.cidb.org.za">www.cidb.org.za</a>)</p> <ul style="list-style-type: none"> <li>• Part 2: Labour-based construction methods for earthworks.</li> <li>• Appendix 1: Quantitative Employment Data on Selected Construction Activities.</li> </ul>	Construction Industry Development Board <a href="http://www.cidb.org.za">www.cidb.org.za</a> under the section “job creation”
Water Provision, Sanitation, Solid Waste, and Buildings	Labour-Intensive Construction Guidelines for Water Provision, Sanitation, Solid Waste, and Buildings. ILO. D. Tshabalala et al., 2012.	EPWP Website: <a href="http://www.epwp.gov.za">www.epwp.gov.za</a>

## 9 APPENDIX B: TYPES OF INFRASTRUCTURE WHICH ARE SUITABLE FOR CONSTRUCTION/MAINTENANCE USING LABOUR-INTENSIVE METHODS

### B.1 Roads

The following operations may be carried out using labour-intensive methods:

1. Site clearance.
2. Layer work construction/maintenance including loading, hauling and spreading material.

**Note:** All compaction should be done using conventional compaction equipment and where necessary the use of heavy machinery may be employed to loosen material for excavation by hand. Where significant use of blasting is indicated, then the Works are probably not suitable for labour-intensive methods.

3. Labour-intensive methods may be used when carrying out the following operations:
  - Macadam base course either dry, water bound or emulsion bound; foamed bitumen gravel; emulsion treated gravel; or slurry bound or composite macadams.
  - Application of bitumen bound surface treatment (cold) including spreading and dragging of chips.
  - Slurry treatments to existing or new road surfaces.
  - In situ concrete roads.
  - Segmented block paved roads.
  - Cast in-situ concrete pavements (including Ultra-Thin Reinforced Concrete)
  - Hyson-cells;
  - Road markings.
4. Fencing.
5. Erection of road signs.
6. Grass maintenance.
7. Road reserve maintenance.
8. Rubble masonry bridges, culverts and retaining walls.

### B.2 Stormwater

The following operations may be constructed and maintained using labour-intensive construction/maintenance methods:

1. Gabions and Reno mattresses.
2. Small diameter pre-cast concrete elements (pipes and arches).
3. Grassed or lined water channels.

### **B.3 Sewers**

The following operations may be constructed or maintained using labour-intensive construction/maintenance methods:

1. Sewer manholes either in brickwork or using specially manufactured pre-cast manhole rings (individual mass less than 320kg).
2. Sewer manhole covers and lids using specially designed pre-cast units.
3. Shallow maturation or facultative pond of a maximum depth of 2m.
4. Sewer pipe work, particularly small bore/ solids free sewers designed and specified to reduce trench depth.

### **B.4 Water**

The following operations may be constructed or maintained using labour-intensive construction/maintenance methods:

1. Laying of water pipelines, fittings and house connections in all materials (including steel) where the mass of individual pipe lengths does not exceed 320kg.
2. Construction of Ferro-cement reservoirs.
3. Excavation for membrane lined and floating roof reservoirs.
4. Construction of small masonry reservoirs.
5. Spring and well protection measures.
6. Construction of valve and hydrant boxes.

### **B.5 Haul of Material**

Where the haul of any material does not exceed 150m, consideration should be given to the use of local resources for transporting material. This includes the use of animal drawn vehicles and small trailer combinations utilising locally sourced tractors. All loading and offloading can be done by hand.

### **B.6 Electricity**

The following operations may be constructed using labour-intensive methods:

1. Excavation of trenches for reticulation of all voltages.
2. Excavation for and erection of poles for overhead lines.
3. Installation of all electricity cables (joints and terminations by qualified persons).



## **B.7 Houses, schools and clinics**

Housing is seen as labour-intensive, but the number of local people that could be employed may be enhanced by one or more of the following:

1. Manufacture of masonry elements on site.
2. Excavation of all foundation trenches by hand.
3. Manufacture of roof trusses on site.
4. Alternative building technologies referred by Agrément SA.

## **B.8 Green Jobs**

Principles of Green Jobs should be integrated in the design and implementation of various types of infrastructure mentioned in Sections B.1 to B.7. This includes materials and physical assets.

## 10 APPENDIX C: REQUIRED SKILLS PROGRAMMMES

### C.1 Client/ Employer

It is recommended that personnel within public bodies complete skills programmes for NQF registered unit standards or equivalent QCTO qualifications, as set out in Table C.1.

**Table C.1: Skills programme for client / employer staff**

<b>Personnel</b>	<b>NQF</b>	<b>Unit Standard Title</b>	<b>Skills Programme Description</b>
Senior management and professionals	7	Develop and Promote Labour-Intensive Construction Strategies or equivalent QCTO qualification	Skills Programme against this single unit standard or part qualification
Middle (technical)	5	Manage Labour-Intensive Construction Projects or equivalent QCTO qualification	Skills Programme against this single unit standard or part qualification

### C.2 Consultants

The person responsible for the design and documentation of the labour-intensive works, must have completed the NQF level 7 unit standard "Develop and Promote Labour-Intensive Construction Strategies" or equivalent QCTO qualification. (See Table C.2).

The Employer's Representative must have completed the NQF level 5 unit standard "Manage Labour-Intensive Construction Projects" or equivalent QCTO qualification. (See Table C.2).

**Table C.2: Skills programme for consultants**

<b>Personnel</b>	<b>NQF</b>	<b>Unit standard Title</b>	<b>Skills Programme Description</b>
Employer's Representative / Site Supervisor	5	Manage Labour-Intensive Construction Projects or equivalent QCTO qualification	Supervisor Skills Programme against this single unit standard or part qualification
Designer	7	Develop and Promote Labour-Intensive Construction Strategies or equivalent QCTO qualification	Skills Programme against this single unit standard or part qualification

### C.3 Contractors

The unit standards for contractors or equivalent QCTO qualification are outlined in Table C.3.

Personnel	NQF	Unit standard Titles	Skills Programme Description
Foreman / Supervisor	4	Implement Labour-Intensive Construction Systems and Techniques or equivalent QCTO qualification	<p>This unit standard or qualification must be completed, <b>and</b></p>  <p>any one of the 3 unit standards or part qualifications must be completed</p>
		Use Labour-Intensive Construction Methods to Construct and Maintain Roads and Stormwater Drainage or equivalent QCTO qualification	
		Use Labour-Intensive Construction Methods to Construct and Maintain Water and Sanitation Services or equivalent QCTO qualification	
		Use Labour-Intensive Construction Methods to Construct, Repair and Maintain Structures or equivalent QCTO qualification	
Site Agent / Manager	5	Manage Labour-Intensive Construction Processes or equivalent QCTO qualification	Skills Programme against this single unit standard or part qualification

# 11 APPENDIX D: PROGRAMMES, INDICATORS AND MINIMUM LABOUR INTENSITY TARGETS

## D.1: EPWP INFRASTRUCTURE PROGRAMMES AND SUB-PROGRAMMES FOR PHASE 3

	<b>Programmes</b>	<b>Sub-programmes</b>
1.	National Youth Service (NYS)	National Youth Service - National National Youth Service - Provincial
2.	Large Projects	Roads and storm water Construction Roads and storm water Maintenance Buildings Construction Buildings Maintenance Water reticulation construction Water reticulation maintenance Bulk water supply Sewer reticulation Electrification Sanitation Other ( Must be described)
3.	Municipal Infrastructure	Roads and storm water Construction Roads and storm water Maintenance Buildings Construction Buildings Maintenance Water reticulation construction Water reticulation maintenance Bulk water supply Sewer reticulation Electrification Sanitation Other ( Must be described)
4.	Vuk'uphile programme	Roads and storm water Construction Roads and storm water Maintenance Buildings Construction Buildings Maintenance Water reticulation construction Water reticulation maintenance Bulk water supply Sewer reticulation Electrification Sanitation Other ( Must be described)

	<b>Programmes</b>	<b>Sub-programmes</b>
5.	Provincial Roads	High volume roads construction High volume roads maintenance Low volume roads construction Low volume roads maintenance Zimbabwe road maintenance Iterele road maintenance Siyatentela road maintenance Household contractor road maintenance
6	Provincial Infrastructure –Non Roads	Building construction Building Maintenance Dam construction
7.	National / State Owned Enterprises	Building construction Building maintenance Dam construction Bulk water supply Sanitation Energy generation Energy transmission Other ( must be described)

## D.2: INDICATORS AND RECOMMENDED LABOUR INTENSITY FOR INFRASTRUCTURE PROJECTS

A minimum labour-intensity threshold appropriate to each sector has been set. Furthermore, programmes within each sector have their own minimum labour intensity thresholds according to categories and sub-categories. It cannot be over-emphasised that the minimum labour intensity is not the default target that should be achieved, but the lowest threshold, above which the target must be set. There is no maximum labour intensity defined as this will be dictated by the type and nature of the project. However, in any case labour intensity cannot exceed 100%. Table D1 provides the minimum Labour intensity indicators for all Infrastructure Sector categories.

**Table D1: Indicators and Recommended Labour Intensity for Infrastructure Projects**

Category	Sub-Category	Indicators	Recommended Minimum Range of LI
Buildings	Construction	No., m <sup>2</sup>	10-30%
	Maintenance	No., m <sup>2</sup>	20-70%
	Landscaping	m <sup>2</sup>	40-70%
Roads and Stormwater – High Volume	Construction/ Upgrading/ Rehabilitation	Km., lane-km	10-30%
	Maintenance – Routine	Km., lane-km, m <sup>2</sup>	40-90%
	Maintenance – Periodic	Km., lane-km, m <sup>2</sup>	15-40%
	Fencing	Km., m	20-50%
Roads and Stormwater – Low Volume	Construction/ Upgrading/ Rehabilitation (Gravel/ Sealed)	Km., lane-km	15-35%
	Maintenance – Routine	Km., lane-km, m <sup>2</sup>	70-90%
	Maintenance – Periodic	Km., lane-km, m <sup>2</sup>	20-50%
	Non-Motorized Transport/ Sidewalks (Exclusive of Rehabilitation of Structures)	Km., m <sup>2</sup>	15-40%

Stormwater	Construction	Km.	15-30%
	Maintenance	Km.	40-90%
Water Reticulation	Construction	Km.	10-35%
Bulk Water Supply	Construction	Km.	10-25%
Sewer Reticulation	Construction	Km.	10-35%
Sanitation	Construction	No.,	10-30%
Water and Sewer Reticulation Maintenance *	Maintenance	Km., No.	15-40%
Solid Waste Management	Land Fill Sites	m <sup>3</sup> , m <sup>2</sup> , No.	10-25%
Electricity	Reticulation	Km., No. of Households/ Units	20-40%
	Generation	**	**
Railway	Lines Refurbishment	Km.	10-30%

\* Minimum labour intensity for water and sewer reticulation Maintenance requiring heavy plant/equipment should be treated on a case by case basis.

\*\* For energy generation the indicators and minimum labour intensity will be determined on a case by case basis as there are many options for energy generation.

## D.3: OTHER INDICATORS FOR INFRASTRUCTURE SECTOR SERVICES AND ASSETS

### National Youth Service and Building Maintenance Programme

SERVICE	INDICATORS
Employment	No. of Work opportunities
Class room Training	No. of certificates issued
Work placement	No. of youth placed
Exits	No. of workshops held, youths exit

### Vuk'uphile Contractor Development Programme

ASSET	INDICATORS
Employment	No. of Work opportunities
Learnership	No. of people trained
Work placement	No. of contractor entities developed
Exits	No. of learners exited

### State Owned Enterprises

ASSET	INDICATORS
Water pump stations	No. of pump stations
Dams	No. of dams
Power stations and substations	No. of Power stations/substations
Railway station maintenance	No. of stations



## 12 APPENDIX E: CONSULTANT'S COMPLIANCE DECLARATION

Public bodies shall use the form (E1) as a guideline for agreements with consultants responsible for designing; and (E2) for project managers supervising implementation of labour-intensive projects.

### E.1: EPWP Project Design Compliance Declaration

*(to be inserted in Consultancy Agreement and filled-in by Consultant<sup>1</sup>)*

Name of Implementing Agency: .....			FY.....		
Project Name:	.....		Project/Contract No.:	.....	
Consulting Firm:	.....		Project Manager:	.....	
Stage/ Element/ Process	Procedure and/or Activity	Compliance requirement	Reference: EPWP Guidelines, DORA Frameworks & Business Process		Compliant? Yes/No
			EPWP Clause	Page	
Qualification and Experience of Service Providers	Consultant Qualified in terms of EPWP Guidelines	Relevant NQF Qualification and Experience for Designers and Supervisors of LI Projects	Appendix C. Table C.2		
Design	Design compliance to EPWP	Design amenable to use of Labour-Intensive Methods			
	Labour intensity (LI)	Minimum L.I. Set & included in Tender document	Appendix D Table D1		
	Optimization of employment Creation	<ul style="list-style-type: none"> <li>- Use of materials with high LI</li> <li>- Identification of L.I. work items in Bills of Quantities</li> <li>- Labour-Intensive Work Methods</li> <li>- Appropriate Tools and Equipment</li> <li>- Applicable task rates based on site conditions</li> <li>- Convergence with other Programmes and Sectors</li> <li>- Green Jobs</li> <li>- Sustainable Livelihoods</li> </ul>			
Standard EPWP-complaint Tender & Contract Document	Standard EPWP-Compliant Procurement Doc. adapted to specific project	Rate of pay set by Implementing Agency in Tender Document	2.2		
		Tender Eligibility	3.3.1		

		Contract Data	3.3.2		
		Scope of Works	3.3.3		
		Demographic requirements			
		Code of Good Practice for EPWP; Applicable labour laws, health & safety and environmental requirements	3.3.2		
		Pricing Instructions on L.I.	3.3.4		
		SANS 1914-5 Recruitment of Local Labour			
		Generic L.I. Specification			

**Declaration:**

I, .....(*Name of Designer*) hereby certify that the above-mentioned project has been appropriately designed; procurement documents and reporting templates prepared in accordance with the “*Code of Good Practice for EPWP*” and the latest edition of “*EPWP Guidelines for Implementation of Infrastructure projects*”, in order to optimise employment creation to achieve the stipulated minimum project Labour Intensity (LI).

Signature: .....

Date: .....

## E.2.: EPWP Project Supervision Compliance Declaration

(to be inserted in Consultancy Agreement and filled-in by Consultant/Project Manager)

### Name of Public Implementing Body:

FY.....

Project Name:	.....		Project/Contract No.:	.....	
Consulting Firm:	.....		Project Manager:	.....	
Stage/ Element/ Process	Procedure and/or Activity	Compliance requirement	Reference: EPWP Guidelines, DORA Frameworks & Business Process		Compliant? Yes/No
			EPWP Clause	Page	
Project Management	Supervision, Monitoring & Evaluation	Records per EPWP Reporting System	3.2		
		Registration of Project on Reporting System			
		Compliance on:			
		- Code of Good Practice for EPWP			
		- L.I items			
		- Quality standards achieved			
		- Convergence with other programmes and sectors incorporated			
		- Green Jobs Principles incorporated			
		- Sustainable Livelihood Principles incorporated			
	Certification of Works: Payment Certificates include EPWP Report	6 – Consultant Scope of works			

### Declaration:

I, .....(Name of Supervising Consultant/ Project Manager) do certify that the project has been supervised in compliance with all EPWP requirements in accordance with the “Code of Good Practice for EPWP” and the latest edition of “EPWP Guidelines for Implementation of Infrastructure projects”, have optimised employment creation and achieved the stipulated minimum project Labour Intensity (LI).

Signature: ..... Date.....

# 13 APPENDIX F.1: IMPLEMENTING PUBLIC BODY MONITORING COMPLIANCE TEMPLATE

EPWP Compliance Checklist to be filled in by Public Implementing Body (I.B.)

Name of Public Implementing Body: .....

FY:.....

Institutional /Business Process	Procedure and/or Activity	Compliance requirement	Reference: EPWP Guidelines, DORA Frameworks & Business Process		Compliant? Yes/No
			EPWP Clause	Page	
IDP/ Strategic Planning	Project Selection/ Prioritization	Policy Statement on Construction Method for applicable IDP Projects	2.1		
Institutional Capacity	Institutional Structure	Political & Administrative Structure in Place	EPWP Policy Guideline		
		EPWP Champion Appointed			
	EPWP made part of Key Performance Areas(KPAs) of Senior Management				
	Qualification of Staff	I.A. Staff meet qualification requirements	Annex C. Table C.1		
Supply Chain Management & Business Process/ Procedures	Qualification of Service Providers	Service Providers database : Qualification Requirements for Consultants	Annex C. Table C.2		
		EPWP-Compliant Standard documents for Appointment of Consultants	3.2; Annex C, Table C.2		
		EPWP Reporting requirements for Consultants & Contractors	3.2		
		Service Providers database : Qualification Requirements for Contractors	Annex C, Table C.3		
	Streamlined Payment Procedures				
	Standard Procurement Documents	EPWP-Compliant Standard Procurement Documents used incorporating Universal Principles, Convergence, Sustainable Livelihoods and Green Jobs.	3.3		
	EPWP Project Document- Branding	EPWP Corporate Identity Manual			
	Prioritization of EPWP Projects	Project Budget from Conditional Grants sufficient to meet EPWP Projects	DORA Conditional Grant Frameworks		
	Project List/Annual Business Plan	Employment targets estimated per project	Business Plan Annex 1.		
	Annual Procurement Plan	Aligned to EPWP Conditional Grant Framework Timelines	DORA Conditional Grant Frameworks		
Project management	Business Plan	Monitoring Plan/Templates in place	Business Plan		
		Procedure for Registration of Projects on IRS	IRS Procedure		
		Project Bill Boards have EPWP Branding			
	Payments	Timely payments for work done			
		Payment Certificates include EPWP Report	Project Compliance Checklist		

\*EPWP Guidelines

Name.....Title.....Signature.....Date.....

Appendix F.2: EPWP Business Plan Template

PROJECT LIST FOR:										
Sector	Focus Area	Project Name	Project Number	Date of approval of project	Project Budget in 201../1..	Funding from EPWP Grant	Number of WOs	Number of FTEs	Start date	End date
<b>Official's Name:</b>			<b>Designation:</b>			<b>Signature:</b>			<b>Date:</b>	

Appendix F.3: EPWP Business Process Monitoring Template

Implementing Agency:..... FY..... Quarter..... Month..... Date.....

S/N	Project name	Budget (Rand) X 1000	Budget Breakdown by Source of Funding (Rand) x 1000			Est. Employment Target				Project Status (Tick)			Labour Requirements Met? (Y/N)				Plan of Action	
			MIG	Integrated Grant	Other	Estimated		Actual to-date					UIF	COIDA	OHS	EPWP Min. Wage		
						WO	FTE	WO	FTE	Plan ning	Procure ment	Impleme ntation					Challenges	Mitigation

## 14 APPENDIX G: TASK RATES

Appendix G 1 shows typical and indicative task rates ranges for various types of infrastructure activities. Appendix G 2 shows references to detailed information on task rates.

### G.1.: TYPICAL AND INDICATIVE TASK RATES

	ACTIVITY	UNIT	TASK RATE RANGE	REMARKS
Road/Building/water and Sanitation works	Bush clearing	m <sup>2</sup>	200 - 350	
	Clearing & Grubbing	m <sup>2</sup>	100 - 150	
	Stump removal	No.	Day work	Depends on size
	Boulder removal	No.	Day work	Depends on size
	Excavation			
	<i>Soft/loose soil</i>	m <sup>3</sup>	2.0 - 4.0	
	<i>Medium</i>	m <sup>3</sup>	2.0 - 3.0	
	<i>Stiff/Hard</i>	m <sup>3</sup>	1.0 - 2.0	
	<i>Very hard</i>	m <sup>3</sup>	0.8 - 1.0	
	Gravel excavation	m <sup>3</sup>	1.0 - 3.0	
	Compaction (pedestrian-ride on roller)	m <sup>2</sup>	700 - 1000	
	Camber Formation	m <sup>2</sup>	60 - 80	
	Loading	m <sup>3</sup>	5 – 8	
	Unloading	m <sup>3</sup>	8 - 10	
	Spreading /soil	m <sup>3</sup>	12 – 15	
	Spreading/Gravel	m <sup>3</sup>	8 – 12	
	Wet stone masonry	m <sup>3</sup>	0.5 - 1.0	
	Stone pitching	m <sup>2</sup>	6 - 10	
	Dry stone masonry	m <sup>3</sup>	1.0 - 2.0	
	Gabion (including assembling & placing rocks)	m <sup>3</sup>	1.8 - 2.0	
	Concrete/mix & place	m <sup>3</sup>	0.5 - 1.0	
	<b>Wheelbarrow haulage</b> (haul distance)			
	0 - 20m	m <sup>3</sup>	7.0 - 8.5	
20 – 40m	“	6.5 - 7.5		
40 – 60m	“	5.5 - 6.5		
60 – 80m	“	5.0 - 5.5		
80 – 100m	“	4.0 - 5.0		

Road works	Install precast concrete culverts (excavation of trench and backfilling)			
	Ø450 mm	m	1.0 - 1.5	
	Ø 600 mm	m	0.9 - 1.2	
	Ø 900 mm	m	0.5 - 0.8	
	<b>Paving:</b> Concrete block placing	m <sup>2</sup>	150 - 200	Team task (10 workers)
	Compaction/block paving units/filling joints	m <sup>2</sup>	15 - 25	
	Lay precast kerb units/concrete beam	m	8 - 12	
	<b>Sealing work</b>			
	Cold mix asphalt	m <sup>2</sup>	900 - 1,000	Team task (16 workers)
	Otta seal	m <sup>2</sup>	5,400 - 5,500	Team task (60 workers)
	Sand seal	m <sup>2</sup>	2,800 - 3,000	Team task (20 workers)
	Modified Otta seal (using emulsion binder)	m <sup>2</sup>	1,300 - 1,500	Team task (16 workers)
	Ultra-thin reinforced concrete	m <sup>2</sup>	400 - 500	Team task (25 workers)
	Building works	Plastering	m <sup>2</sup>	15 - 20
Brick masonry		m <sup>3</sup>	0.7 - 1.0	
Formwork		m <sup>2</sup>	15 - 22	
Ceiling work including brandering		m <sup>2</sup>	25 - 30	
Roof Coverings		m <sup>2</sup>	30 - 35	
<b>Tiling</b> /glazed tiles to walls		m <sup>2</sup>	15 - 20	
Tiling/Ceramic tiles to floors		m <sup>2</sup>	18 - 22	
VA tiles to floor		m <sup>2</sup>	70 - 80	
<b>Glazing</b> /4mm Clear float glass		m <sup>2</sup>	28 - 32	
<b>Paint</b> /On ceilings		m <sup>2</sup>	30 - 34	
On walls		m <sup>2</sup>	35 - 40	
On doors/door frames		m <sup>2</sup>	15 - 20	
On Windows with metal bars		m <sup>2</sup>	25 - 30	
Two coats of varnish to woodwork		m <sup>2</sup>	30 - 35	



<b>Routine road maintenance</b>	Cut grass /on verge/ side drains	m <sup>2</sup>	100 - 150	
	Clean culvert /inlet, outfall	m <sup>3</sup>	1.5 - 2.0	
	Clean side/mitre drains	m <sup>3</sup>	2.0 - 3.0	
	Repair side drain erosion	m <sup>3</sup>	3.0 - 5.0	
	Fill pot holes on carriageway	m <sup>3</sup>	2.0 - 3.0	Gravel roads
	Fill ruts/minor gullies on carriageway	m <sup>2</sup>	5.0 - 10	
	Grub edge/shoulder	m <sup>2</sup>	80 - 100	
	Repair shoulder erosion	m <sup>2</sup>	5.0 - 10	
	Repair culvert headwalls	No	Day work	

## G.2. REFERENCE TO DETAILED INFORMATION ON TASK RATES

Category	Operation	References: Source documents	Tables-Figures-	Pages
Roadwork				
Construction	Earthwork/formation	Implementing Employment Intensive Road Works – A CIDB Practice Manual, March 2007- Manual 3	Table	PP 110-111
	Earthworks	<i>Best practice guide labour-based methods and technologies for employment intensive construction works</i> January 2002 (document commissioned by the department of public works (construction industry development programme	Table G 1 & G2	Page 1.19
			Table N1 & O 1	Page 1.39-41
	Earthworks	Labour-based technologies and methods for employment intensive construction works  best practice guideline 2  labour-based construction methods for Earthworks  April 2004	Table 1 & 2	PP 3-4
Table 8 & 9			Page 13	
Table 10			Page 14	
		Table 12	Page 15	
		Construction of Low Volume Sealed Roads – Good Practice Guide to Labour-Based Methods, ILO A. Asare et. al. 2013	Table 4-4  Table 4-17	Page 4-5  Page 4-20

Category	Operation	References: Source documents	Tables-Figures-	Pages
	Drainage structures (Concrete & masonry works)	Implementing Employment Intensive Road Works – A CIDB Practice Manual, March 2007-Manual 5		Page 100
	Concrete block paving	<i>Best practice guide labour-based methods and technologies for employment intensive construction works</i> January 2002 (document commissioned by the department of public works (construction industry development program	Table C1 Table A 13 and 14	Page 1.15 Page 1.9
	Gravel surfacing	Implementing Employment Intensive Road Works – A CIDB Practice Manual, March 2007-Manual 3	Table -Module 6	PP 110-111
	Stone pavement	<i>Best practice guide labour-based methods and technologies for employment intensive construction works</i> January 2002 (document commissioned by the department of public works (construction industry development program	Table F 1	Page 1.18
		Construction of Low Volume Sealed Roads – Good Practice Guide to Labour-Based Methods, ILO A. Asare et. al. 2013	Table 8-23	Page 8-56
	Pavement/layer works (bituminous pavement seals)	Implementing Employment Intensive Road Works – A CIDB Practice Manual, March 2007-Manual 4	Table –Module 7	PP 90-91
		Construction of Low Volume Sealed Roads – Good Practice Guide to Labour-Based Methods, ILO A. Asare et. al. 2013	Table 5-6 Table 8-25	Page 5-23 Page 8-59 & 60

Category	Operation	References: Source documents	Tables-Figures-	Pages
		<i>Best practice guide labour-based methods and technologies for employment intensive construction works</i> January 2002 (document commissioned by the department of public works (construction industry development program	Table J1 Table N1	Page 1.21 Page 1.40
	Concrete and masonry drainage works and structures	Implementing Employment Intensive Road Works – A CIDB Practice Manual, March 2007-Manual 5	Table – Module 8	Page 100
Maintenance	Road Maintenance	<b>Common Routine maintenance activities</b>  Study on Enhancing Labour Intensity in the <b>Expanded Public Works Programme Road Infrastructure Projects South Africa 2012</b>		Page 51
		<b>Maintenance of minor roads using the length man contractor system;</b> Jones, T E and R C Petts, 1991. Maintenance of minor roads using the lengthman contractor system. <i>Fifth International Conference on Low Volume Roads, Raleigh North Carolina, 19-23 May 1991. Transportation Research Record 1291, Volume 1.</i> Washington DC: Transportation Research Board, National Research Council, 41-52.)	Table 1  Table 2	Page 3-4  Page 5
		Labour-based Road Works Technical Manual: Appropriate Technology Unit (ATU) Tanzania Ministry Of Works  International Labour Organization (ILO) & Intech-Associates Consulting Engineers: May 1997  Productivity Standards for Routine Maintenance and Routine Maintenance Productivity Guideline	Figure D1.1 and D1.2	

Category	Operation	References: Source documents	Tables-Figures-	Pages
	<b>Road and drainage works</b>	<b><i>Productivity Norms for Labour-Based Construction. ASIST Information Service Technical Brief No. 2. International Labour Organisation 1998.</i></b>  <b><i>Includes Roadwork and drainage Productivity Norms Data from countries.</i></b>	<b><i>Tables M1-22</i></b>	
Building/ Housing related works	Various activities	<i>Best practice guide labour-based methods and technologies for employment intensive construction works</i> January 2002 (document commissioned by the department of public works (construction industry development programme))	Table-1  Table A 1-6	Page 3  PP-1.1-1.5
	Concrete and masonry drainage works and structures	Implementing Employment Intensive Road Works – A CIDB Practice Manual, March 2007-Manual 5	Table –Module 8	Page 100
Water and sanitation	Storm water drainage	<i>Best practice guide labour-based methods and technologies for employment intensive construction works</i> January 2002 (document commissioned by the department of public works (construction industry development programme))	Table H1	Page 1.20

# 15 APPENDIX H: EPWP REPORTING FORMS

## H.1A: NATIONAL / PROVINCIAL REGISTRATION FORM

This form refers to the project plan, before the start of the project – Not the actual project information

Field requested	Description if needed	Please complete this section
<b>Project name</b>		
Public Body (National Department /Province) Reference number	<i>The number used by the public body to identify the project. This number has to be unique for every project</i>	
Project name	<i>The project name needs to be unique for projects</i>	
Project type:		Select one and mark with a X
	<i>Provincial</i>	
	<i>National</i>	
<b>Project location</b>		
Province	<i>Indicate in which Province the project will be implemented</i>	
District Municipality/ Metro	<i>Indicate in which district/Metro Municipality the project will be implemented</i>	
Local Municipality / Metro region	<i>Indicate in which local municipality the project will be implemented</i>	
Primary Ward	<i>Indicate in which ward the project will be implemented. If the project is implemented in more than one ward, then name the wards in "describe project location"</i>	
Enter the name of the Municipal Area	<i>Indicate in which municipal area the project will be implemented</i>	
Describe the project location	<i>Short description, including the area or ward within the municipality</i>	
<b>Project Ownership and Location</b>		
<b>Project Ownership</b>		Select one and mark with a X
Public Body Type	<i>Provincial Department</i>	
Project owner (Who is funding the project)	<i>This refers to the provincial department who is providing the money. It cannot be a metro, district or municipality.</i>	
Department in the public body that is responsible for the project	<i>This refers to the department within the provincial department</i>	

<b>Field requested</b>	<b>Description if needed</b>	<b>Please complete this section</b>
Implementing public body type (Implementer)	<i>This can be the same provincial department, another provincial department, a metro, district or municipality.</i>	
Project implementer	<i>The name of the provincial department, metro, district or province</i>	
Implementing department	<i>This refers to the department within the public body who is responsible for the implementation of the project</i>	
<b>Project Implementation</b>		
Source of Reference number	<i>Indicate the source of the reference number.</i>	
IGP Registered?	<i>Indicate yes/no</i>	
If the project is IGP registered, what is the IGP reference number?	<i>Provide the IGP number</i>	
<b>EPWP Information</b>		
Choose EPWP Programme		Select one EPWP Programme and mark with a X
	-Not part of a programme-	
	Contractor Development	
	Facilities & Infrastructure Development Programme	
	Housing Delivery	
	Labour Based Construction Programme	
	Labour-Intensive Programme	
	EPWP Provincial	
	MIG	
	NYS Provincial	
	National Youth Service	
	Subsidised Housing	
	Vuk'uphile	
	Vukuzakhe	
	Zibambele	
	Community based	
	NGO	

<b>Field requested</b>	<b>Description if needed</b>	<b>Please complete this section</b>
<b>Project Priority</b>		Select one priority and mark with a X
	1: Labour-intensive and training	
	2: Vuk'uphile learnership	
	3: Labour-intensive, no training	
	4: Other	
	5: Large Projects	
	6: Provincial Access Roads	
	7: EPWP Provincial Maintenance	
	8: EPWP High Volume	
<b>Sector</b>	Infrastructure	
<b>Project sub-sector</b>	Please choose from the following:	Select one sub-sector and mark with an X. If sub-sector is other, then mark with an X and provide name of "other"
	Infrastructure Roads	
	Ground Rehabilitation	
	Roads and Stormwater	
	Settlements and Services	
	Housing	
	Park Development	
	Water Infrastructure Upgrade	
	Sewer upgrade	
	Pipelines	
	Stormwater drains	
	Sidewalks	
	Multipurpose	
	Other	
	Lights Reticulation	
	Paving of parks	
	Parking lots	



Field requested	Description if needed	Please complete this section
If Other, describe		
<b>Project details</b>		
Estimated project start date	<i>Provide start date of the project. This is the construction start date</i>	
Estimated project end date	<i>Provide estimated project end date.</i>	
Please give a short project description	<i>Short description, no longer than one line.</i>	
Project type:	<i>Infrastructure</i>	
Project Environment		Select one project environment and mark with a X
	<i>Urban</i>	
	<i>Rural</i>	
	<i>Both Urban and Non-Urban</i>	
<b>Budget allocated</b>		
Source of funds	<i>Which organisations will be contributing to the funding of the project? Please choose from the following:</i>	Select one or more sources of funds and mark with a X
	<i>Donors</i>	
	<i>EPWP</i>	
	<i>IGP</i>	
	<i>Loans</i>	
	<i>National</i>	
	<i>Provincial Capital Budget</i>	
	<i>Provincial Department</i>	
	<i>Provincial Maintenance Budget</i>	
	<i>Up-scaling Grant</i>	
Total Amount of budget	<i>Provide budget amount</i>	
<b>Project Contact in public body</b>		
<b>Name and Contact</b>		
Title:	Provide information	
Surname:	Provide information	

<b>Field requested</b>	<b>Description if needed</b>	<b>Please complete this section</b>
Initials:	Provide information	
E-mail address	Provide information	
Cellular:	Provide information	
Telephone (Office):	Provide information	
Fax:	Provide information	
Cellular:	Provide information	
Physical Address:	Provide information	
Postal Address: (if different from Physical)	Provide information	

## H.1B: MUNICIPAL REGISTRATION FORM

This form refers to the project plan, before the start of the project – Not the actual project information

Field requested	Description if needed	Please complete this section
<b>Project name</b>		
Public Body (Municipal) Reference number	<i>The number used by the public body to identify the project. This number has to be unique for every project</i>	
Project name	<i>The project name needs to be unique for projects</i>	
Project type:		Select one and mark with a X
	Municipal	
<b>Project location</b>		
Province	<i>Indicate in which Province the project will be implemented</i>	
District Municipality/ Metro	<i>Indicate in which district/Metro Municipality the project will be implemented</i>	
Local Municipality / Metro region	<i>Indicate in which local municipality the project will be implemented</i>	
Primary Ward	<i>Indicate in which ward the project will be implemented. If the project is implemented in more than one ward, then name the wards in "describe project location"</i>	
Enter the name of the Municipal Area	<i>Indicate in which municipal area the project will be implemented</i>	
Describe the project location	<i>Short description, including the area or ward within the municipality</i>	
<b>Project Ownership and Location</b>		
Project Ownership		
Public Body Type		Select one and mark with a X
Project owner (Who is funding the project)		
Department in the public body that is responsible for the project	<i>This refers to the department within the municipality</i>	
Implementing public body type (Implementer)	<i>This must be a district, local or metro municipality</i>	
Project implementer	<i>The municipality responsible for implementing the project.</i>	
Implementing department	<i>This refers to the department within the municipality who is responsible for the implementation of the project</i>	

Field requested	Description if needed	Please complete this section
<b>Project Implementation</b>		
Source of Reference number	<i>Indicate the source of the reference number.</i>	
IDP Reference Number allocated to the project		
MIG Registered?	<i>Indicate yes/no</i>	
If the project is MIG registered, what is the MIG reference number?	<i>Provide the IGP number</i>	
<b>EPWP Information</b>		
Choose EPWP Programme		Select one EPWP Programme and mark with a X
	-Not part of a programme-	
	Contractor Development	
	Facilities & Infrastructure Development Programme	
	Housing Delivery	
	Labour-Based Construction Programme	
	Labour-Intensive Programme	
	EPWP Provincial	
	MIG	
	NYS Provincial	
	National Youth Service	
	Subsidised Housing	
	Vuk'uphile	
	Vukuzakhe	
	Zibambele	
	Community based	
	NGO	
Project Priority		Select one priority and mark with a X
	<i>1: Labour-intensive and training</i>	
	<i>2: Vuk'uphile learnership</i>	
	<i>3: Labour-intensive, no training</i>	

Field requested	Description if needed	Please complete this section
	4: Other	
	5: Large Projects	
Sector	Infrastructure	
Project sub-sector	Please choose from the following:	Select one sub-sector and mark with an X. If sub-sector is other, then mark with an X and provide name of "other"
	Infrastructure Roads	
	Ground Rehabilitation	
	Roads and Stormwater	
	Settlements and Services	
	Housing	
	Park Development	
	Water Infrastructure Upgrade	
	Sewer upgrade	
	Pipelines	
	Stormwater drains	
	Sidewalks	
	Multipurpose	
	Other	
	Lights Reticulation	
	Paving of parks	
	Parking lots	
If Other, describe		
<b>Project details</b>		
Estimated project start date	Provide start date of the project. This is the construction start date	
Estimated project end date	Provide estimated project end date.	
Please give a short project description	Short description, no longer than one line.	
Project type:	Infrastructure	
Project Environment		Select one project environment and mark with a X

Field requested	Description if needed	Please complete this section
	<i>Urban</i>	
	<i>Rural</i>	
	<i>Both Urban and Non-Urban</i>	
Budget allocated		
Source of funds	<i>Which organisations will be contributing to the funding of the project? Please choose from the following:</i>	Select one or more sources of funds and mark with a X
	<i>District Municipality</i>	
	<i>Donors</i>	
	<i>EPWP</i>	
	<i>IGP</i>	
	<i>Loans</i>	
	<i>Local Municipality</i>	
	<i>MIG</i>	
	<i>National Department</i>	
	<i>Provincial Department</i>	
Total Amount of budget	<i>Provide budget amount</i>	
Project Contact in public body		
Name and Contact		
Title:	Provide information	
Surname:	Provide information	
Initials:	Provide information	
E-mail address	Provide information	
Cellular:	Provide information	
Telephone (Office):	Provide information	
Fax:	Provide information	
Cellular:	Provide information	
Physical Address:	Provide information	
Postal Address: (if different from Physical)	Provide information	

## H.2A: NATIONAL/PROVINCIAL SUBMISSION FORM

This form refers to the project plan, before the start of the project – Not the actual project information

Field requested	Description if needed	Comment
<b>Budget</b>		
Source of funds	<i>Which organisations will be contributing to the funding of the project and how much will each organisation contribute? Please choose from the following:</i>	Budget amounts
	<i>Donors</i>	
	<i>EPWP</i>	
	<i>IGP</i>	
	<i>Loans</i>	
	<i>National</i>	
	<i>Provincial Capital Budget</i>	
	<i>Provincial Department</i>	
	<i>Provincial Maintenance Budget</i>	
	<i>Up-scaling Grant</i>	
What will be the annual budgets of the project?	<i>Per national financial year. Take into account all financial years in which this project will be active.</i>	Annual budget amount
	<i>15/16</i>	
	<i>16 / 17</i>	
	<i>17 /18</i>	
	<i>18 /19</i>	
	<i>19/20</i>	
<b>Milestones</b>		
<i>Milestone</i>	<i>Will this milestone be measured (Yes / No)</i>	<i>Target Date</i>
Project approved		
Consultant appointed		
Detailed Design specifications approved		
Tender report approved		
Construction started		
Implementation complete		

Field requested	Description if needed	Comment
<b>EPWP Indicators</b>		
<i>Indicator</i>	<i>Indicate Yes or No</i>	
Consultant contract compliant with EPW guidelines		
Contractor compliant with EPW requirements		
Exit Strategy		
Branding Compliant		
<b>Planned EPWP Infrastructure outputs</b>		
<i>Output</i>	<i>Tick if applicable</i>	<i>Measure in km / sqm / no etc - Indicate value i.e. km of roads to be constructed</i>
Km of roads constructed to standard		
Km of pipelines installed to standard		
Km of storm water drains constructed to standard		
Km of sidewalks constructed to standard		
No of bridges		
No of connections		
No of pipe / box culverts		
No of pump stations		
No of Reservoirs		
No of retention dams		
No of standpipes		
No of transfer facilities		
No of VIP's		
Sqm of bus ranks		
Sqm of community hall		
Sqm of landfill site		
Sqm of taxi ranks		
Sqm of treatment works		
Sqm of buildings		
Sqm of Grass cutting		



Field requested	Description if needed	Comment
Km of fencing		
Sqm of Clinic Construction and Rehabilitation		
Number of classroom construction and rehabilitation		
<b>Planned training</b>		
Accredited courses		
Cost estimate	<i>Provide information if available</i>	
Number or person training days	<i>The total number of days for all persons to attend training</i>	
Number of people to attend	<i>The total number of people that will attend training</i>	
Number of women to attend	<i>This includes adult women and youth women</i>	
Number of youth to attend	<i>All persons aged 35 and under</i>	
Non-accredited		
Cost estimate	<i>Provide information if available</i>	
Number or person training days	<i>The total number of days for all persons to attend training</i>	
Number of people to attend	<i>The total number of people that will attend training</i>	
Number of women to attend	<i>This includes adult women and youth women</i>	
Number of youth to attend	<i>All persons aged 35 and under</i>	
<b>Planned labour</b>		
Employment generation details	Planned Number of Person days of employment	Planned Persons to be Employed
Adult men		
Adult women		
Youth men		
Youth women		
Disabled		
<b>Planned labour</b>		
Minimum daily wage	<i>As per the contract document</i>	R
Planned number of employees from the indigent list	<i>Has this public body specified that a number of persons from the indigent list have to be employed? If so, what number of persons?</i>	

## H.2B: MUNICIPAL SUBMISSION FORM

This form refers to the project plan, before the start of the project – Not the actual project information

Field requested	Description if needed	Comment
<b>Budget</b>		
Source of funds	<i>Which organisations will be contributing to the funding of the project and how much will each organisation contribute? Please choose from the following:</i>	Budget amounts
	<i>District Municipality</i>	
	<i>Donors</i>	
	<i>EPWP</i>	
	<i>IGP</i>	
	<i>Loans</i>	
	<i>Local Municipality</i>	
	<i>MIG</i>	
	<i>National Department</i>	
	<i>Provincial Department</i>	
What will be the annual budgets of the project?	<i>Per national financial year. Take into account all financial years in which this project will be active.</i>	Annual budget amount
	<i>15/16</i>	
	<i>16 / 17</i>	
	<i>17 /18</i>	
	<i>18 /19</i>	
	<i>19/20</i>	
<b>Milestones</b>		
<i>Milestone</i>	<i>Will this milestone be measured (Yes / No)</i>	<i>Target Date</i>
Project approved		
Consultant appointed		
Detailed Design specifications approved		
Tender report approved		
Construction started		

Field requested	Description if needed	Comment
Implementation complete		
<b>EPWP Indicators</b>		
<i>Indicator</i>	<i>Indicate Yes or No</i>	
Consultant contract compliant with EPW guidelines		
Contractor compliant with EPW requirements		
Exit Strategy		
Branding Compliant		
<b>Planned EPWP Infrastructure outputs</b>		
<i>Output</i>	<i>Tick if applicable</i>	<i>Measure in km / sqm / no etc - Indicate value i.e. km of roads to be constructed</i>
Km of roads constructed to standard		
Km of pipelines installed to standard		
Km of storm water drains constructed to standard		
Km of sidewalks constructed to standard		
No of bridges		
No of connections		
No of pipe / box culverts		
No of pump stations		
No of Reservoirs		
No of retention dams		
No of standpipes		
No of transfer facilities		
No of VIP's		
Sqm of bus ranks		
Sqm of community hall		
Sqm of landfill site		
Sqm of taxi ranks		
Sqm of treatment works		
Sqm of buildings		

Field requested	Description if needed	Comment
Sqm of Grass cutting		
Km of fencing		
Sqm of Clinic Construction and Rehabilitation		
Number of classroom construction and rehabilitation		
<b>Planned training</b>		
Accredited courses		
Cost estimate	<i>Provide information if available</i>	
Number or person training days	<i>The total number of days for all persons to attend training</i>	
Number of people to attend	<i>The total number of people that will attend training</i>	
Number of women to attend	<i>This includes adult women and youth women</i>	
Number of youth to attend	<i>All persons aged 35 and under</i>	
Non-accredited		
Cost estimate	<i>Provide information if available</i>	
Number or person training days	<i>The total number of days for all persons to attend training</i>	
Number of people to attend	<i>The total number of people that will attend training</i>	
Number of women to attend	<i>This includes adult women and youth women</i>	
Number of youth to attend	<i>All persons aged 35 and under</i>	
<b>Planned labour</b>		
Employment generation details	Planned Number of Person days of employment	Planned Persons to be Employed
Adult men		
Adult women		
Youth men		
Youth women		
Disabled		
<b>Planned labour</b>		
Minimum daily wage	<i>As per the contract document</i>	R
Planned number of employees from the indigent list	<i>Has this public body specified that a number of persons from the indigent list have to be employed? If so, what number of persons?</i>	

### H.3: PROGRESS REPORT FORM (NATIONAL, PROVINCIAL AND MUNICIPAL)

Data form for a 12 months period.

	April	May	June	July	August	September	October	November	December	January	February	March
<b>Financial Report</b>												
Expenditure for current month												
<b>EPWP Certified Contractors</b>												
Number of contractors												
Amount Spent												
<b>SMME Contractors</b>												
Number of contractors												
Amount Spent												
<b>Milestones</b>	If milestone has been achieved provide the achievement date, otherwise indicate "NO" for each milestone not achieved.	If milestone has been achieved provide the achievement date, otherwise indicate "NO" for each milestone not achieved.	If milestone has been achieved provide the achievement date, otherwise indicate "NO" for each milestone not achieved.	If milestone has been achieved provide the achievement date, otherwise indicate "NO" for each milestone not achieved.	If milestone has been achieved provide the achievement date, otherwise indicate "NO" for each milestone not achieved.	If milestone has been achieved provide the achievement date, otherwise indicate "NO" for each milestone not achieved.	If milestone has been achieved provide the achievement date, otherwise indicate "NO" for each milestone not achieved.	If milestone has been achieved provide the achievement date, otherwise indicate "NO" for each milestone not achieved.	If milestone has been achieved provide the achievement date, otherwise indicate "NO" for each milestone not achieved.	If milestone has been achieved provide the achievement date, otherwise indicate "NO" for each milestone not achieved.	If milestone has been achieved provide the achievement date, otherwise indicate "NO" for each milestone not achieved.	If milestone has been achieved provide the achievement date, otherwise indicate "NO" for each milestone not achieved.
Project approved												
Consultant appointed												
Detailed Design specifications approved												

	April	May	June	July	August	September	October	November	December	January	February	March
Tender report approved												
Construction started												
Implementation complete												
<b>Actual Outputs</b>												
Type of output												
Quantity achieved												
Date achieved												

#### H.4: PARTICIPANTS INFORMATION (NATIONAL, PROVINCIAL AND MUNICIPAL)

Please provide participants information on this sheet for each month of the year.

Month of report:	
Contractor Name:	
CIPRO company registration number:	
Type of contractor:	
Project Name:	
Project Type:	
Source of Funding:	
Province:	

Physical Outputs for month:	
Project Number:	
Total Project Expenditure for month:	
Contract Number:	
Invoice Number:	
Project Start Date:	
Project End Date:	
Certified by Project Manager:	
Date of certification:	

									MONTH			
First name	Initials	Last name	I.D. Number	DOB	Gender	Has disability	Education level	Start date	Number of labour days for the month	Daily wage rate for the month	Total wages paid for the month	Total number of training days for the Month
				dd/mm/yyyy	M or F	Y or N	See codes at bottom of list	dd/mm/yyyy			DO NOT ENTER DATA IN THIS COLUMN	
											0	
											0	
<b>TOTALS (DO NOT ENTER DATA IN THIS LINE)</b>									<b>0</b>		<b>0</b>	<b>0</b>

Education Levels – use the codes (1,2,3) on the excel spreadsheet

- (1) Unknown
- (2) No Schooling
- (3) Grade 1-3 (Sub A – Std 1)
- (4) Grad 4 (Std 2) ABET 1
- (5) Grade 5-6 (Std 3-4) ABET 2
- (6) Grade 7-8 (Std 5-6) ABET 3
- (7) Grade 9 (Std 7) ABET 4
- (8) Grade 10-11 (Std 8-9)
- (9) Grade 12 (Std 10)
- (10) Post Matric





# 16 APPENDIX I: EPWP BRANDING FORMAT

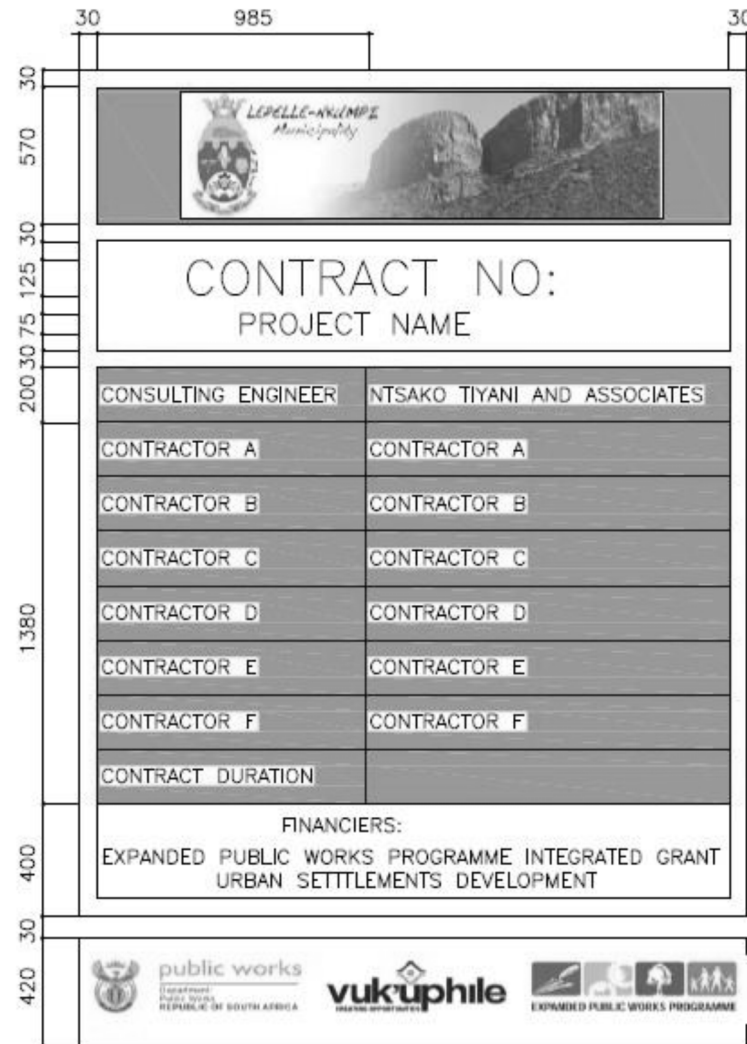



**MINISTERIAL DETERMINATION  
FOR EPWP  
(Revised 2012)**



---

**GOVERNMENT NOTICE**

---

**DEPARTMENT OF LABOUR**

No. R. 347

4 May 2012

**BASIC CONDITIONS OF EMPLOYMENT ACT, 1997****MINISTERIAL DETERMINATION 4: EXPANDED PUBLIC WORKS PROGRAMMES**

I, Nelisiwe Mildred Oliphant, Minister of Labour, hereby in terms of section 50 of the Basic Conditions of Employment Act, 1997, make a Ministerial Determination establishing conditions of employment for employees in Expanded Public Works Programmes, South Africa, in the Schedule hereto and determine the second Monday after the date of publication of this notice as the date from which the provisions of the said Ministerial Determination shall become binding.

All the provisions of the Ministerial Determination: Expanded Public Works Programmes published under Government Notice R949 in Government Gazette 33665 of 22 October 2010 will be superseded by this ministerial determination with effect from the date of implementation.

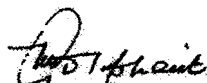

**NM OLIPHANT, MP**  
Minister of Labour

10/04/2012

**SCHEDULE****MINISTERIAL DETERMINATION NO: 3 ; EXPANDED PUBLIC WORKS PROGRAMMES****Index**

- 
1. Definitions
  2. Application of this determination
  3. Sections not applicable to public works programmes
  4. Conditions
-

## 1. **Definitions**

1.1 In this determination –

“expanded public works programme” means a programme to provide public or community assets or services through a labour intensive programme initiated by government and funded from public resources.

1.2 Without limiting subsection (1), the following programmes constitute Expanded Public Works Programmes:

- (a) Environment and Culture Sector Programmes including: Working for Water, Working on Fire, Working for Wetlands, People and Parks, Working for Energy, Working for Woodlands, Working for the Coast, Landcare, Working on Waste, Working for Tourism, Investing in Culture Programmes
- (b) Infrastructure Sector Programmes and Projects declared part of EPWP which may include the construction, rehabilitation and maintenance of: rural and low-volume roads, storm-water drains, water reticulation, basic sanitation, footpaths, sidewalks, bicycle paths, schools and clinics.
- (c) Social Sector Programmes including Early Childhood Development, Home, Community Based Care, Community Safety and other community based programmes
- (d) All projects and programmes accessing the EPWP wage incentive including those implemented by Non Governmental organisations (NGO) and Community Based Organisations (CBO) and the Community Works Programme.
- (e) Any other programme deemed to be part of the EPWP as determined by the Department of Public Works

## 2. **Application**

This Determination applies to all employers and employees engaged in expanded public works programmes.

## 3. **The following provisions of the Basic Conditions of Employment Act do not apply to public works programmes –**

3.1 Section 10(2) [Overtime rate]

- 
- |     |                      |  |
|-----|----------------------|--|
| 3.2 | Section 14(3)        | [Remuneration required for meal intervals of longer than 75 minutes] |
| 3.3 | Section 29(h) to (p) | [Written particulars of employment]                                  |
| 3.4 | Section 30           | [Display of employee's rights]                                       |
| 3.5 | Section 41           | [Severance pay]  |
| 3.6 | Section 37           | [Notice of termination]  |
| 3.7 | Sections 51 – 58     | [Sectoral Determinations]  |

#### 4. **Conditions**

As set out in the ANNEXURE:



**ANNEXURE****CONDITIONS OF EMPLOYMENT FOR EXPANDED PUBLIC WORKS PROGRAMMES****1. Introduction**

1.1 This document contains the standard terms and conditions for workers employed in elementary occupations on an Expanded Public Works Programme (EPWP). These terms and conditions do NOT apply to persons employed in the supervision and management of a SPWP.

1.2 In this document –

- (a) “department” means any department of the State, implementing agent or contractor;
- (b) “employer” means any department, implementing agency or contractor that hires workers to work in elementary occupations on a EPWP;
- (c) “worker” means any person working in an elementary occupation on a EPWP;
- (d) “elementary occupation” means any occupation involving unskilled or semi-skilled work;
- (e) “management” means any person employed by a department or implementing agency to administer or execute an EPWP;
- (f) “task” means a fixed quantity of work;
- (g) “task-based work” means work in which a worker is paid a fixed rate for performing a task;
- (h) “task-rated worker” means a worker paid on the basis of the number of tasks completed;
- (i) “time-rated worker” means a worker paid on the basis of the length of time worked.

**2. Terms of Work**

2.1 Workers on an EPWP are employed on a temporary basis or contract basis.

### 3. **Normal Hours of Work**

- 3.1 An employer may not set tasks or hours of work that require a worker to work--
- (a) more than forty hours in any week;
  - (b) on more than five days in any week; and
  - (c) for more than eight hours on any day.
- 3.2 An employer and worker may agree that a worker will work four days per week. The worker may then work up to ten hours per day.
- 3.3 A task-rated worker may not work more than a total of 55 hours in any week to complete the tasks allocated (based on a 40-hour week) to that worker.

### 4. **Meal Breaks**

- 4.1 A worker may not work for more than five hours without taking a meal break of at least thirty minutes duration.
- 4.2 An employer and worker may agree on longer meal breaks.
- 4.3 A worker may not work during a meal break. However, an employer may require a worker to perform duties during a meal break if those duties cannot be left unattended and cannot be performed by another worker. An employer must take reasonable steps to ensure that a worker is relieved of his or her duties during the meal break.
- 4.4 A worker is not entitled to payment for the period of a meal break. However, a worker who is paid on the basis of time worked must be paid if the worker is required to work or to be available for work during the meal break.

### 5. **Special Conditions for Security Guards**

- 5.1 A security guard may work up to 55 hours per week and up to eleven hours per day.
- 5.2 A security guard who works more than ten hours per day must have a meal break of at least one hour or two breaks of at least 30 minutes each.

**6. Daily Rest Period**

Every worker is entitled to a daily rest period of at least twelve consecutive hours. The daily rest period is measured from the time the worker ends work on one day until the time the worker starts work on the next day.

**7. Weekly Rest Period**

Every worker must have two days off every week. A worker may only work on their day off to perform work which must be done without delay and cannot be performed by workers during their ordinary hours of work ("emergency work").

**8. Sick Leave**

- 8.1 Only workers who work more than 24 hours per month have the right to claim sick-pay in terms of this clause.
- 8.2 A worker who is unable to work on account of illness or injury is entitled to claim one day's paid sick leave for every full month that the worker has worked in terms of a contract.
- 8.3 A worker may accumulate a maximum of twelve days' sick leave in a year.
- 8.4 Accumulated sick-leave may not be transferred from one contract to another contract.
- 8.5 An employer must pay a task-rated worker the worker's daily task rate for a day's sick leave.
- 8.6 An employer must pay a time-rated worker the worker's daily rate of pay for a day's sick leave.
- 8.7 An employer must pay a worker sick pay on the worker's usual payday.
- 8.8 Before paying sick-pay, an employer may require a worker to produce a certificate stating that the worker was unable to work on account of sickness or injury if the worker is –
  - (a) absent from work for more than two consecutive days; or
  - (b) absent from work on more than two occasions in any eight-week period.

- 8.9 A medical certificate must be issued and signed by a medical practitioner, a qualified nurse or a clinic staff member authorised to issue medical certificates indicating the duration and reason for incapacity.
- 8.10 A worker is not entitled to paid sick-leave for a work-related injury or occupational disease for which the worker can claim compensation under the Compensation for Occupational Injuries and Diseases Act.

9. **Maternity Leave**

- 9.1 A worker may take up to four consecutive months' unpaid maternity leave.
- 9.2 A worker is not entitled to any payment or employment-related benefits during maternity leave.
- 9.3 A worker must give her employer reasonable notice of when she will start maternity leave and when she will return to work.
- 9.4 A worker is not required to take the full period of maternity leave. However, a worker may not work for four weeks before the expected date of birth of her child or for six weeks after the birth of her child, unless a medical practitioner, midwife or qualified nurse certifies that she is fit to do so.
- 9.5 A worker may begin maternity leave –
- (a) four weeks before the expected date of birth; or
  - (b) on an earlier date –
    - (i) if a medical practitioner, midwife or certified nurse certifies that it is necessary for the health of the worker or that of her unborn child; or
    - (ii) if agreed to between employer and worker; or
  - (c) on a later date, if a medical practitioner, midwife or certified nurse has certified that the worker is able to continue to work without endangering her health.
- 9.6 A worker who has a miscarriage during the third trimester of pregnancy or bears a stillborn child may take maternity leave for up to six weeks after the miscarriage or stillbirth.

**10. Family responsibility leave**

10.1 Workers, who work for at least four days per week, are entitled to three days paid family responsibility leave each year in the following circumstances -

- (a) when the employee's child is born;
- (b) when the employee's child is sick;
- (c) in the event of a death of –
  - (i) the employee's spouse or life partner;
  - (ii) the employee's parent, adoptive parent, grandparent, child, adopted child, grandchild or sibling.

**11. Statement of Conditions**

11.1 An employer must give a worker a statement containing the following details at the start of employment –

- (a) the employer's name and address and the name of the EPWP;
- (b) the tasks or job that the worker is to perform; and
- (c) the period for which the worker is hired or, if this is not certain, the expected duration of the contract;
- (d) the worker's rate of pay and how this is to be calculated;
- (e) the training that the worker will receive during the EPWP.

11.2 An employer must ensure that these terms are explained in a suitable language to any employee who is unable to read the statement.

11.3 An employer must supply each worker with a copy of these conditions of employment.

**12. Keeping Records**

12.1 Every employer must keep a written record of at least the following –

- (a) the worker's name and position;

- (b) copy of an acceptable worker identification
  - (c) in the case of a task-rated worker, the number of tasks completed by the worker;
  - (d) in the case of a time-rated worker, the time worked by the worker;
  - (e) payments made to each worker.
- 12.2 The employer must keep this record for a period of at least three years after the completion of the EPWP.

### 13. **Payment**

- 13.1 An employer must pay all wages at least monthly in cash or by cheque or into a bank account.
- 13.2 A worker may not be paid less than the minimum EPWP wage rate of R63.18 per day or per task. This will be adjusted annually on the 1<sup>st</sup> of November in-line with inflation (available CPI as provided by StatsSA six (6) weeks before implementation).
- 13.3 A task-rated worker will only be paid for tasks that have been completed.
- 13.4 An employer must pay a task-rated worker within five weeks of the work being completed and the work having been approved by the manager or the contractor having submitted an invoice to the employer.
- 13.5 A time-rated worker will be paid at the end of each month.
- 13.6 Payment must be made in cash, by cheque or by direct deposit into a bank account designated by the worker.
- 13.7 Payment in cash or by cheque must take place –
- (a) at the workplace or at a place agreed to by the worker;
  - (b) during the worker's working hours or within fifteen minutes of the start or finish of work;
  - (c) in a sealed envelope which becomes the property of the worker.
- 13.8 An employer must give a worker the following information in writing –

- (a) the period for which payment is made;
- (b) the numbers of tasks completed or hours worked;
- (c) the worker's earnings;
- (d) any money deducted from the payment;
- (e) the actual amount paid to the worker.

13.9 If the worker is paid in cash or by cheque, this information must be recorded on the envelope and the worker must acknowledge receipt of payment by signing for it.

13.10 If a worker's employment is terminated, the employer must pay all monies owing to that worker within one month of the termination of employment.

#### 14. **Deductions**

14.1 An employer may not deduct money from a worker's payment unless the deduction is required in terms of a law.

14.2 An employer must deduct and pay to the SA Revenue Services any income tax that the worker is required to pay.

14.3 An employer who deducts money from a worker's pay for payment to another person must pay the money to that person within the time period and other requirements specified in the agreement law, court order or arbitration award concerned.

14.4 An employer may not require or allow a worker to –

- (a) repay any payment except an overpayment previously made by the employer by mistake;
- (b) state that the worker received a greater amount of money than the employer actually paid to the worker; or
- (c) pay the employer or any other person for having been employed.

#### 15. **Health and Safety**

15.1 Employers must take all reasonable steps to ensure that the working environment is healthy and safe.

- 15.2 A worker must –
- (a) work in a way that does not endanger his/her health and safety or that of any other person;
  - (b) obey any health and safety instruction;
  - (c) obey all health and safety rules of the EPWP;
  - (d) use any personal protective equipment or clothing issued by the employer;
  - (e) report any accident, near-miss incident or dangerous behaviour by another person to their employer or manager.

16. **Compensation for Injuries and Diseases**

- 16.1 It is the responsibility of the employers (other than a contractor) to arrange for all persons employed on a EPWP to be covered in terms of the Compensation for Occupational Injuries and Diseases Act, 130 of 1993.
- 16.2 A worker must report any work-related injury or occupational disease to their employer or manager.
- 16.3 The employer must report the accident or disease to the Compensation Commissioner.
- 16.4 An employer must pay a worker who is unable to work because of an injury caused by an accident at work 75% of their earnings for up to three months. The employer will be refunded this amount by the Compensation Commissioner. This does NOT apply to injuries caused by accidents outside the workplace such as road accidents or accidents at home.

17. **Termination**

- 17.1 The employer may terminate the employment of a worker for good cause after following a fair procedure.
- 17.2 A worker will not receive severance pay on termination.
- 17.3 A worker is not required to give notice to terminate employment. However, a worker who wishes to resign should advise the employer in advance to allow the employer to find a replacement.



- 17.4 A worker who is absent for more than three consecutive days without informing the employer of an intention to return to work will have terminated the contract. However, the worker may be re-engaged if a position becomes available.
- 17.5 A worker who does not attend required training events, without good reason, will have terminated the contract. However, the worker may be re-engaged if a position becomes available.

**Certificate of Service**

- 18.1 On termination of employment, a worker is entitled to a certificate stating –
- (a) the worker's full name;
  - (b) the name and address of the employer;
  - (c) the EPWP on which the worker worked;
  - (d) the work performed by the worker;
  - (e) any training received by the worker as part of the EPWP;
  - (f) the period for which the worker worked on the EPWP;
  - (g) any other information agreed on by the employer and worker.
-







**DATA COLLECTION TOOL**

*NOTE: The field with the asterick indicates the mandantory.\*\*\**

**Column A**

**Column B**

**Project Details**

Project Name \*\*\*  
Project Reference Number \*\*\*  
Project description \*\*\*  
Project Start Date \*\*\*  
Project End Date \*\*\*  
Estimated Budget \*\*\*

**Project Location**

Province \*\*\*  
District/Metro Municipality \*\*\*  
Local Municipality/Metro Region \*\*\*  
Latitude (in decimal format)  
Longitude (in decimal format)

**Public Body Details**

Public body sphere \*\*\*  
Reporting public body that is the project owner (and will report on the project) \*\*\*  
Implementing public body type \*\*\*  
Public body that will implement the project  
MIG/IDP reference number allocated to the project

**EPWP Details**

EPWP Sector\*\*\*  
EPWP Program \*\*\*  
EPWP Sub programme \*\*\*

Infrastructure

**Budget Amount**

Financial year \*\*\*  
Total Budget Amount \*\*\*  
Wages \*\*\*  
UIF \*\*\*  
COIDA \*\*\*  
Training  
Administration  
Equipment and materials  
Other  
Describe if other

1

**Outputs and Training**

Output \*\*\*  
Description \*\*\*  
Target Quantity \*\*\*  
Number of persons to be trained

**Contact person**

Title\*\*\*  
Initials\*\*\*  
First Name\*\*\*  
Surname\*\*\*  
Email  
Tel (Office)\*\*\*  
Fax Number  
Cell Number\*\*\*  
Physical Address \*\*\*  
Postal Address  
Postal code

Beneficiary Details <i>*** NOTE: Give as much information as you possible can on the beneficiaries details.</i>														Location Details <i>***</i>				Household Details <i>***</i>					
FirstName <i>***</i>	Initials <i>***</i>	Surname <i>***</i>	Idnumber <i>***</i>	DateOfBirth <i>***</i>	Gender <i>***</i>	Disability <i>***</i>	StartDate <i>***</i>	EndDate <i>***</i>	Education level <i>***</i>	Language <i>***</i>	Address <i>***</i>	Nationality <i>***</i>	Cell Number <i>***</i>	Government Grant <i>***</i>	Province <i>***</i>	District <i>***</i>	Municipality <i>***</i>	Ward No. <i>***</i>	Number of people in Household <i>***</i>	Number of Dependants in Household <i>***</i>	Number of Children attending school <i>***</i>		

Project Location	
Column A	Column B
Locality Name ***	
Municipality***	
Ward ***	
Subplace***	
Government Facility***	
Project Location ***	

**Payment Details \*\*\***

FirstName ***	Initials ***	Surname ***	Idnumber *** **	DateOfBirth* *** **	WageRate ***	TotalPaidDays ***	AmountPaid ***	WorkDays* **	Training Days Paid	TrainingDays NonPaid	Total Training Days	Training Course Id	Month ***	Year ***

Training

ID	Course Name	Code	Type	Start	End	Number of Trainees	Number of Days	Cost	Status	Training Provider



Monthly Progress Report	
Wages ***	
UIF ***	
COIDA ***	
Training	
Administration	
Equipment and materials	
Other	
Describe if other	
Outputs	
Achieved Value ***	
Achieved Percentage ***	

<b>EPWP Employment Information</b>	
<b>Name of Project</b>	
First Name	
Initials	
Surname	
ID Number	
Nationality	
Name of Employer	
Name of Project	
Signature of Employer	
<b>Attachment</b>	
Copy of ID	

Payment Details ***															
Employer		LDPWR&I													
Project Name															
Contract Number															
Reporting Month															
Attach proof of payment or register where employees acknowledged receipt of															
FirstName ***	Initials ***	Surname ***	Idnumber ***	DateOfBirth ***	WageRate ***	No. of Days Worked	AmountPaid ***	WorkDays ***	Training Days Paid	TrainingD ays NonPaid	Total Training Days	Training Course Id	Month ***	Year ***	Signature of Payment Received
1															
2															
3															
4															
5															
6															
7															
8															
9															
10															
11															
12															
13															



## PART C7: SITE INFORMATION AND DRAWINGS



## PART C7.1: SITE INFORMATION

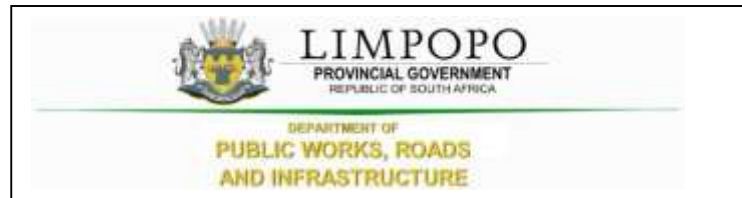

## PART C7.2: DRAWINGS

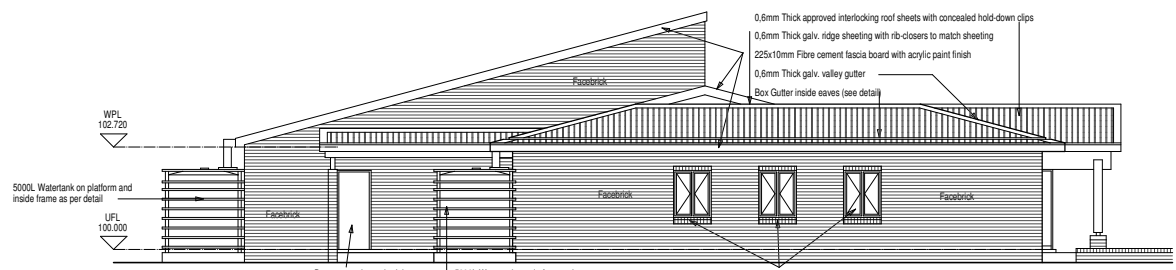

1:100 WEST ELEVATION

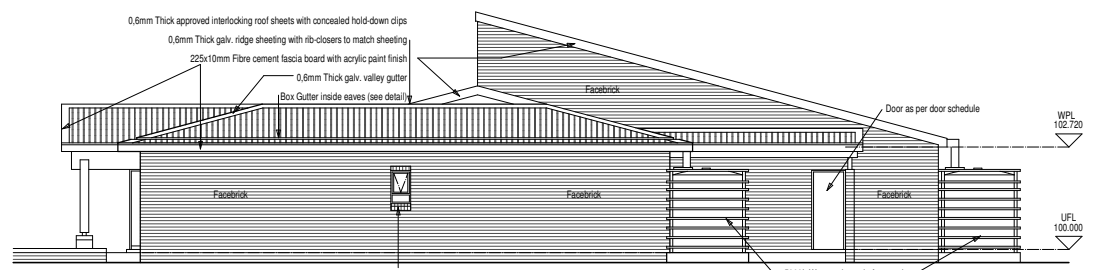

1:100 EAST ELEVATION

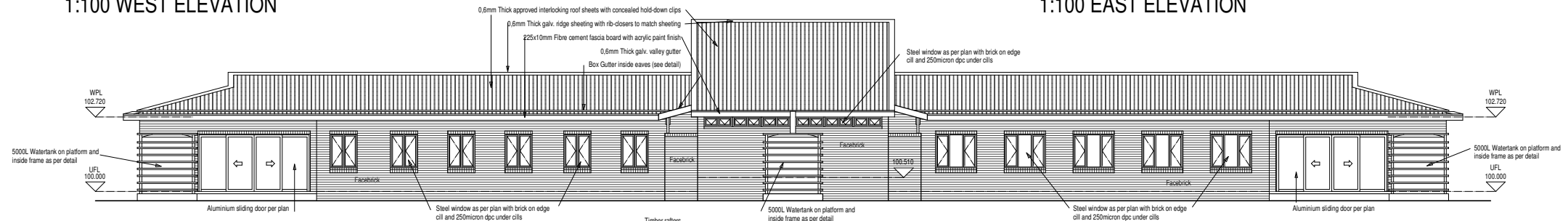

1:100 NORTH ELEVATION

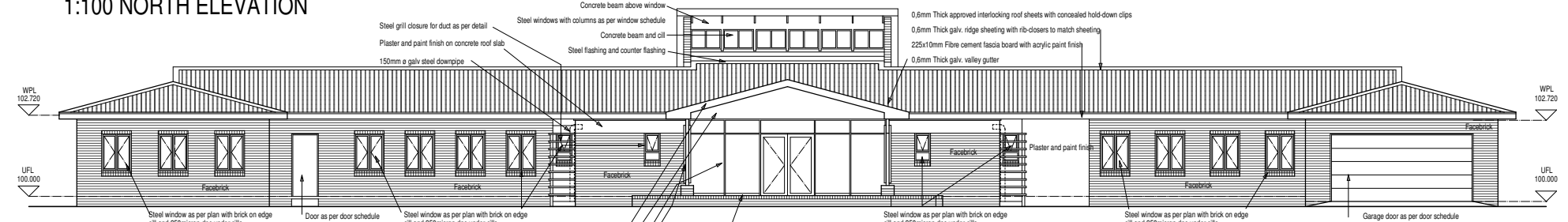

1:100 SOUTH ELEVATION

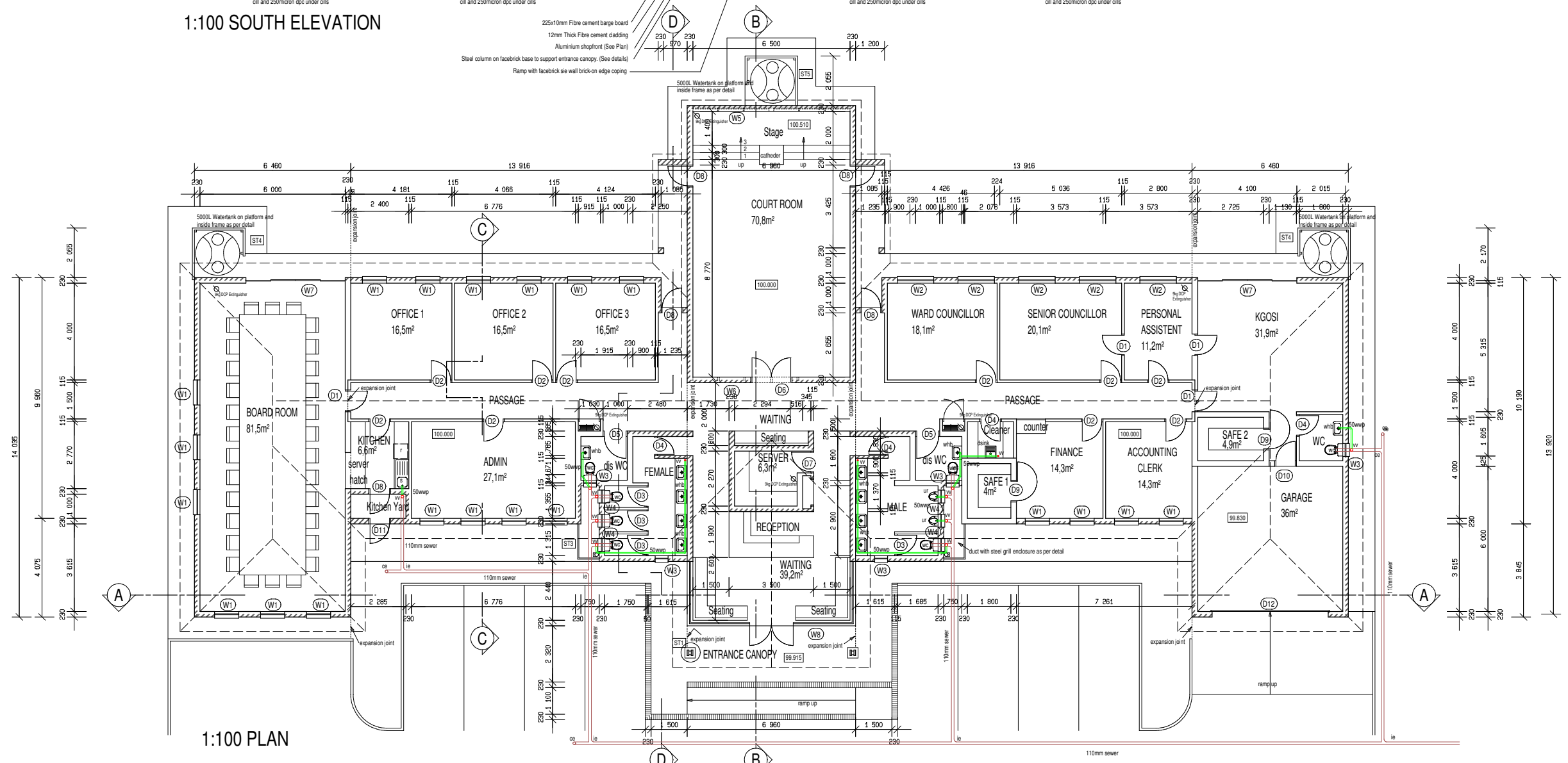

1:100 PLAN

AREAS:  
TOTAL AREA: 623,3m<sup>2</sup>

REVISION	DRAWN	DATE	REV. NO.
WYSIGING	GETEKEN	DATUM	WYS. NR.
PROJECT		PROJEK	
<b>STANDARD TRIBAL OFFICE for THE DEPARTMENT of TRADITIONAL AFFAIRS</b>			
DRAWING	TEKENING		
<b>SITE PLAN LIST OF DRAWINGS</b>			
SCALE	1:100	DRAWN	D.C.
SCALE	1:100	GETEKEN	D.C.
DATE	2018/01/17	CHECKED	D.C.
CLIENT NO.	KLIENT NR.		
PROJECT NO.	STAGE	DRAWING NO.	REVISION
LDPWRI	3	TO 1.2	
PROJEK NR.	PROBAB	TEKENING NR.	WYSIGING

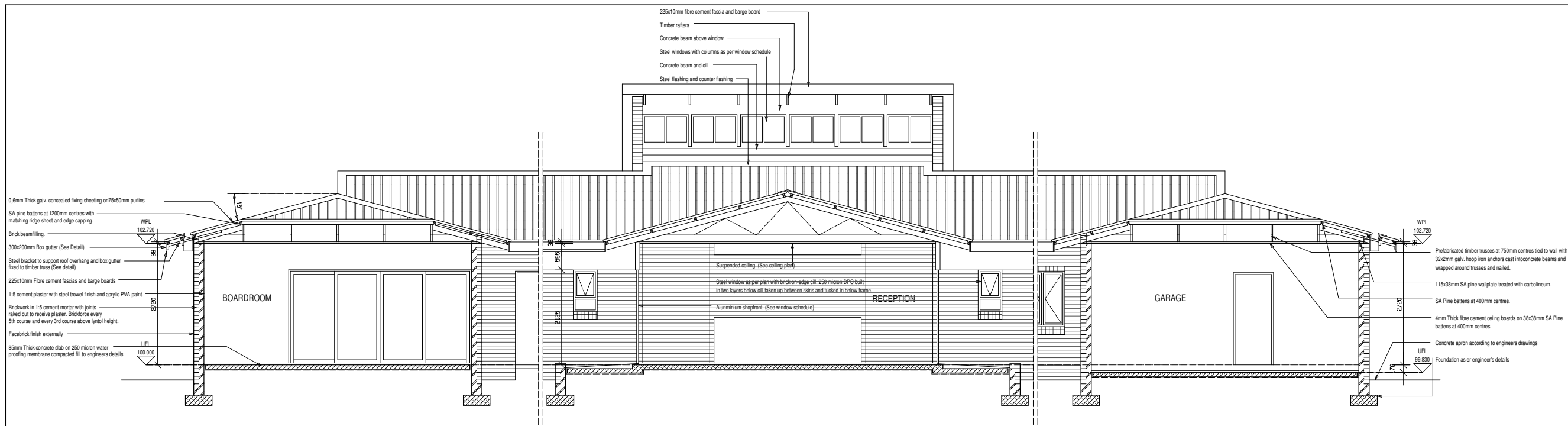

1:50 SECTION A-A

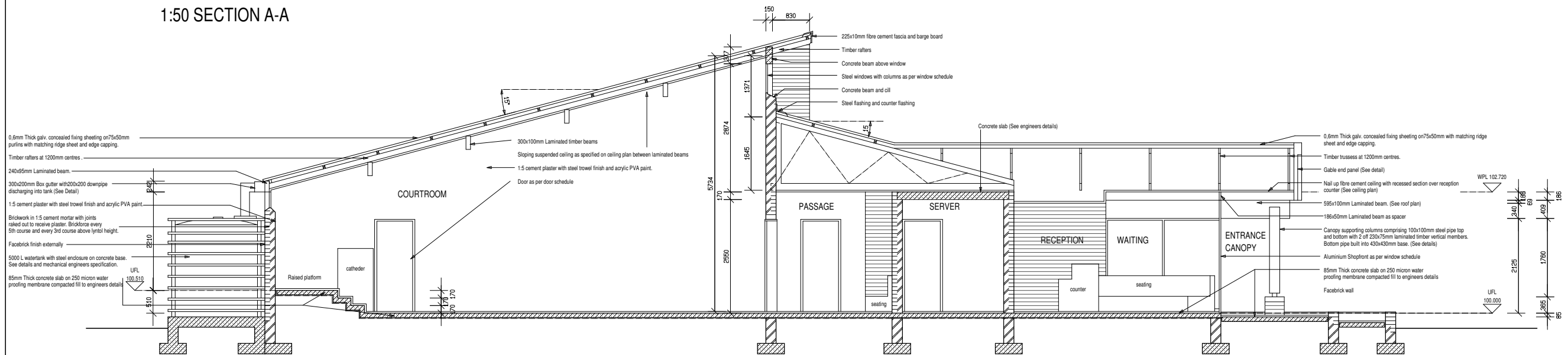

1:50 SECTION B-B

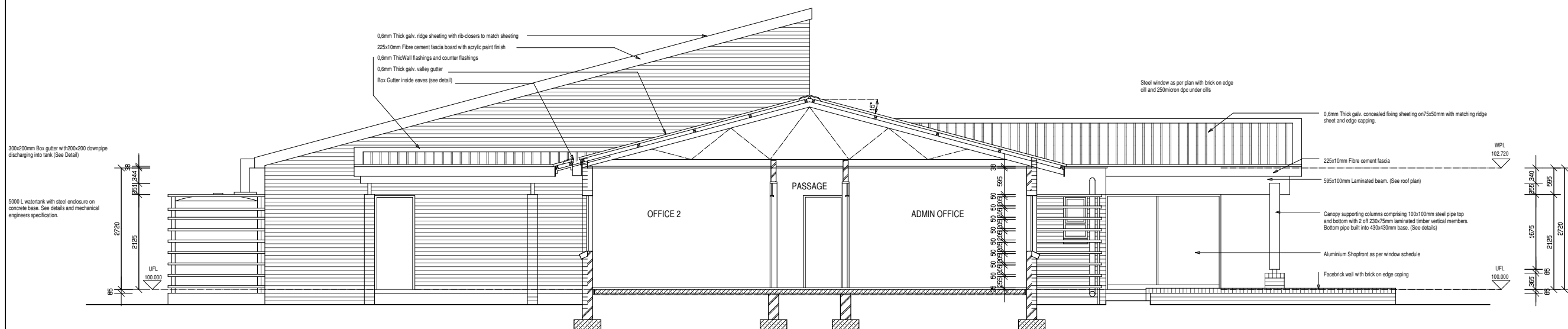

1:50 SECTION C-C

Prefabricated timber trusses at 750mm centres tied to wall with 32x2mm galv. hoop iron anchors cast into concrete beams and wrapped around trusses and nailed.  
 115x38mm SA pine wallplate treated with carbolineum.  
 SA Pine battens at 400mm centres.  
 4mm Thick fibre cement ceiling boards on 38x38mm SA Pine battens at 400mm centres.  
 Steel window as per plan with brick-on-edge sill. 250 micron DPC built in two layers below sill taken up between skins and tucked in below frame.  
 Concrete apron according to engineers drawings  
 Foundation as per engineer's details

0.6mm Thick galv. concealed fixing sheeting on 75x50mm purlins  
 SA pine battens at 1200mm centres with matching ridge sheet and edge capping.  
 Brick beamlining.  
 300x200mm Box gutter (See Detail)  
 Steel bracket to support roof overhang and box gutter fixed to timber truss (See Detail)  
 225x10mm Fibre cement fascia and barge boards  
 1.5 cement plaster with steel trowel finish and acrylic PVA paint.  
 Brickwork in 1.5 cement mortar with joints raked out to receive plaster. Brickwork every 5th course and every 3rd course above lintel height.  
 Facebrick finish externally  
 85mm Thick concrete slab on 250 micron water proofing membrane compacted fill to engineers details

225x10mm fibre cement fascia and barge board  
 Timber rafters  
 Concrete beam above window  
 Steel windows with columns as per window schedule  
 Concrete beam and sill  
 Steel flashing and counter flashing  
 300x100mm Laminated timber beams  
 Sloping suspended ceiling as specified on ceiling plan between laminated beams  
 1.5 cement plaster with steel trowel finish and acrylic PVA paint.  
 Door as per door schedule  
 0.6mm Thick galv. concealed fixing sheeting on 75x50mm purlins with matching ridge sheet and edge capping.  
 Timber trusses at 1200mm centres.  
 Gable end panel (See detail)  
 Nail up fibre cement ceiling with recessed section over reception counter (See ceiling plan)  
 595x100mm Laminated beam (See roof plan)  
 186x50mm Laminated beam as spacer  
 Canopy supporting columns comprising 100x100mm steel pipe top and bottom with 2 of 230x75mm laminated timber vertical members. Bottom pipe built into 430x430mm base. (See details)  
 Aluminium Shopfront as per window schedule  
 85mm Thick concrete slab on 250 micron water proofing membrane compacted fill to engineers details  
 Facebrick wall

REVISION	DRAWN	DATE	REV NO.
WYSIGING	GETEKEN	DATUM	WYS NR.
PROJECT		PROJEK	
<b>STANDARD TRIBAL OFFICE for THE DEPARTMENT of TRADITIONAL AFFAIRS</b>			
DRAWING		TEKENING	
<b>SECTIONS A, B + C</b>			
SCALE	1:50	DRAWN	D.C.
SCALE		GETEKEN	
DATE	2018/01/17	CHECKED	D.C.
CLIENT NO.		KLIENT NR.	
PROJECT NO.	STAGE	DRAWING NO.	REVISION
LDPWRI	3	TO 1.3.1	
PROJEK NR.	PROBAB	TEKENING NR.	WYSIGING



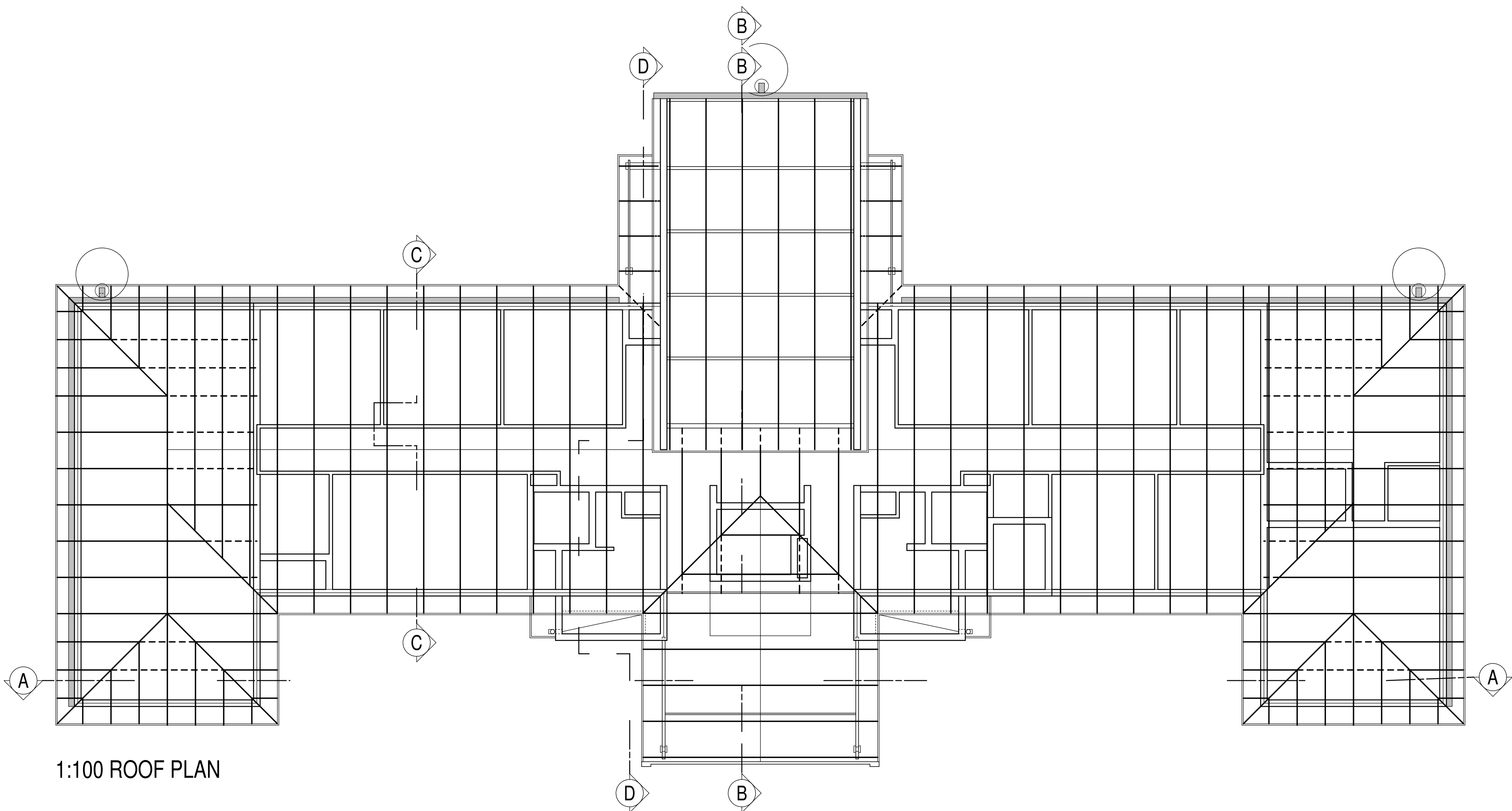
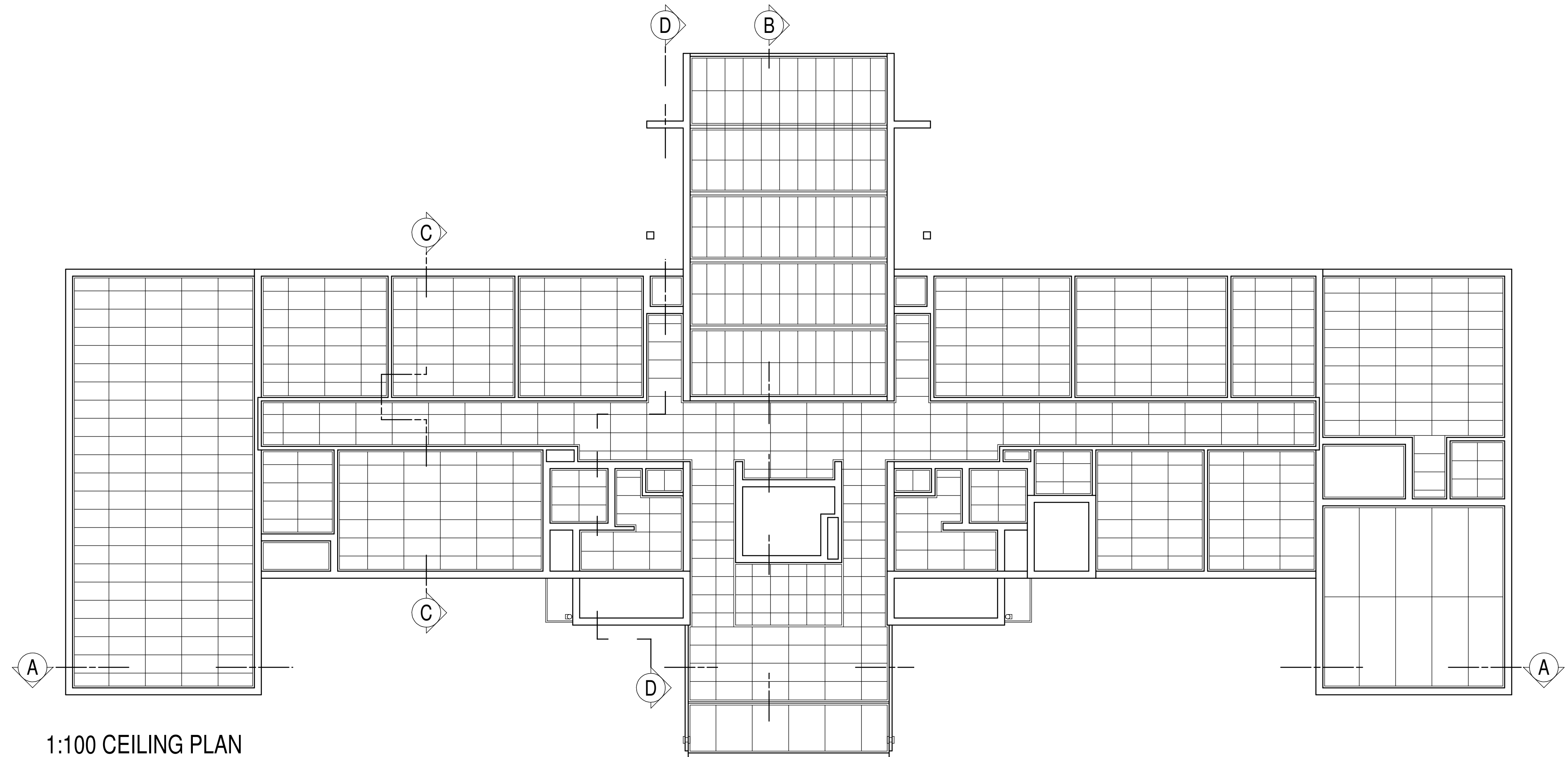

REVISION	DRAWN	DATE	REV NO.
WYSIGING	GETEKEN	DATUM	WYS NR.
PROJECT		PROJEK	
<b>STANDARD TRIBAL OFFICE</b> for THE DEPARTMENT of TRADITIONAL AFFAIRS			
DRAWING		TEKENING	
<b>ROOF PLAN</b> <b>CEILING PLAN</b>			
SCALE	1:100	DRAWN	D.C.
SKAAL		GETEKEN	
DATE	2018/01/17	CHECKED	D.C.
CLIENT NO.		CLIENT NR.	
PROJECT NO.	LDPWRI	STAGE	3
		DRAWING NO.	TO 1.5
REVISION			
PROJEK NR.	PROBAB	TEKENING NR.	WYSIGING

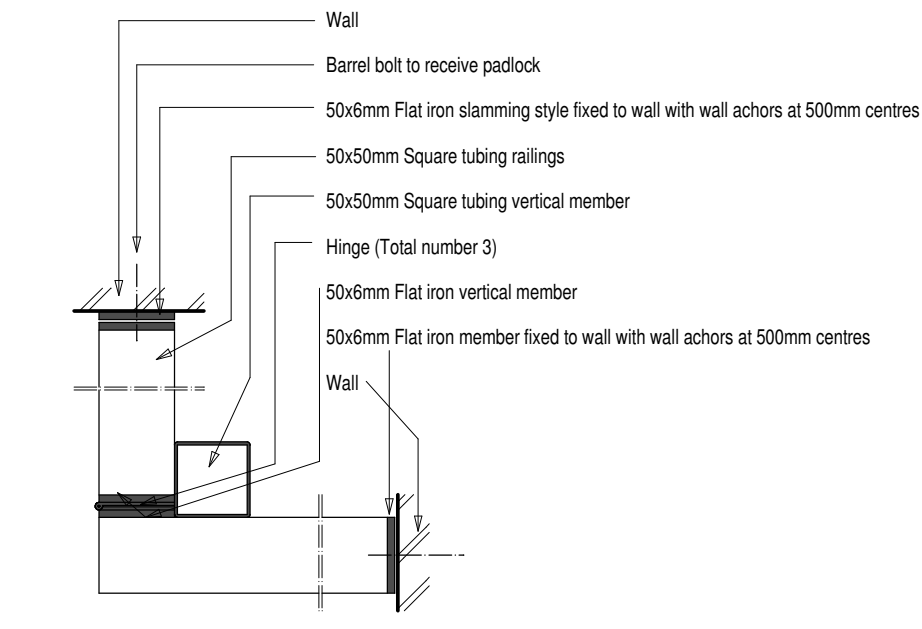
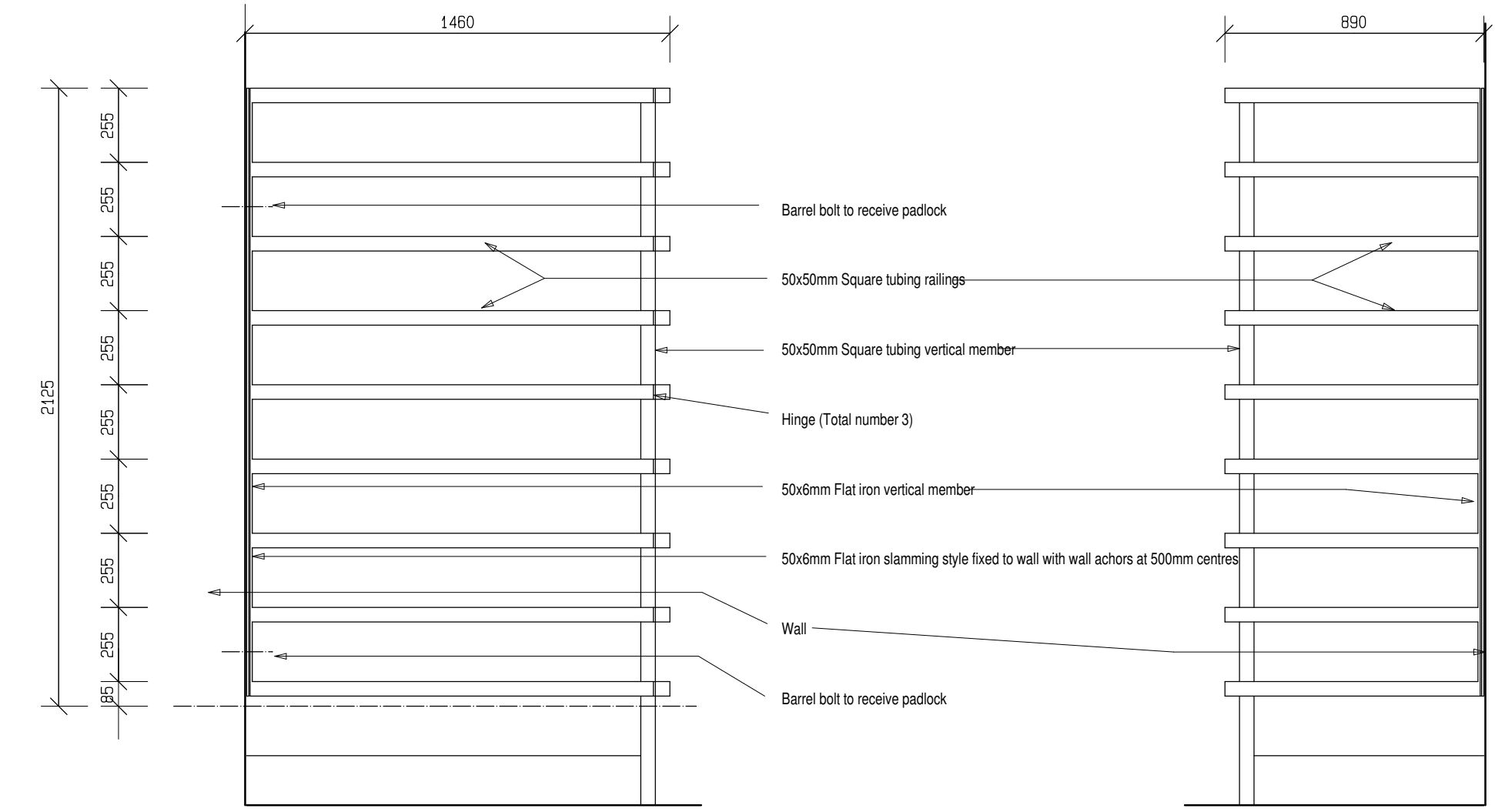
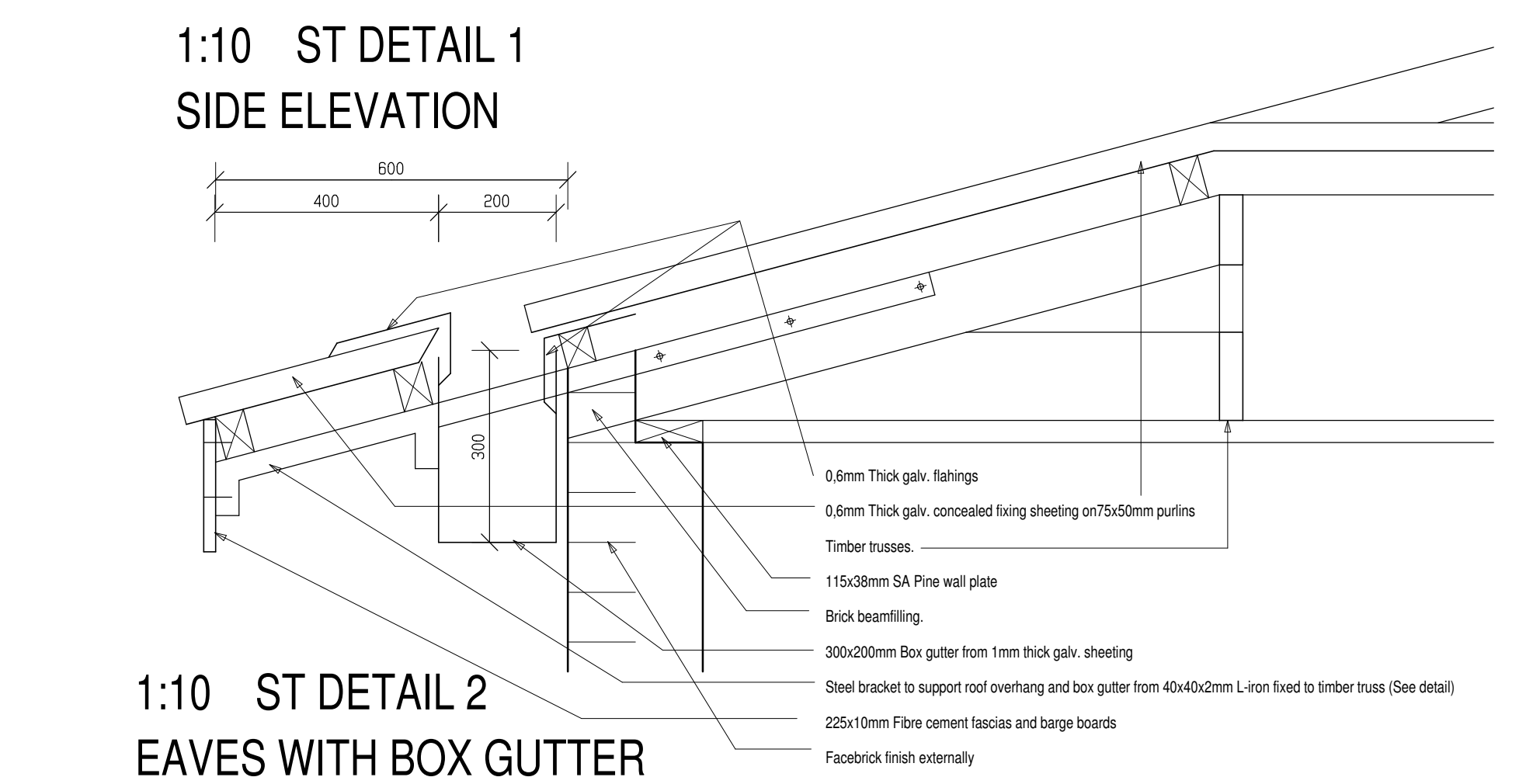
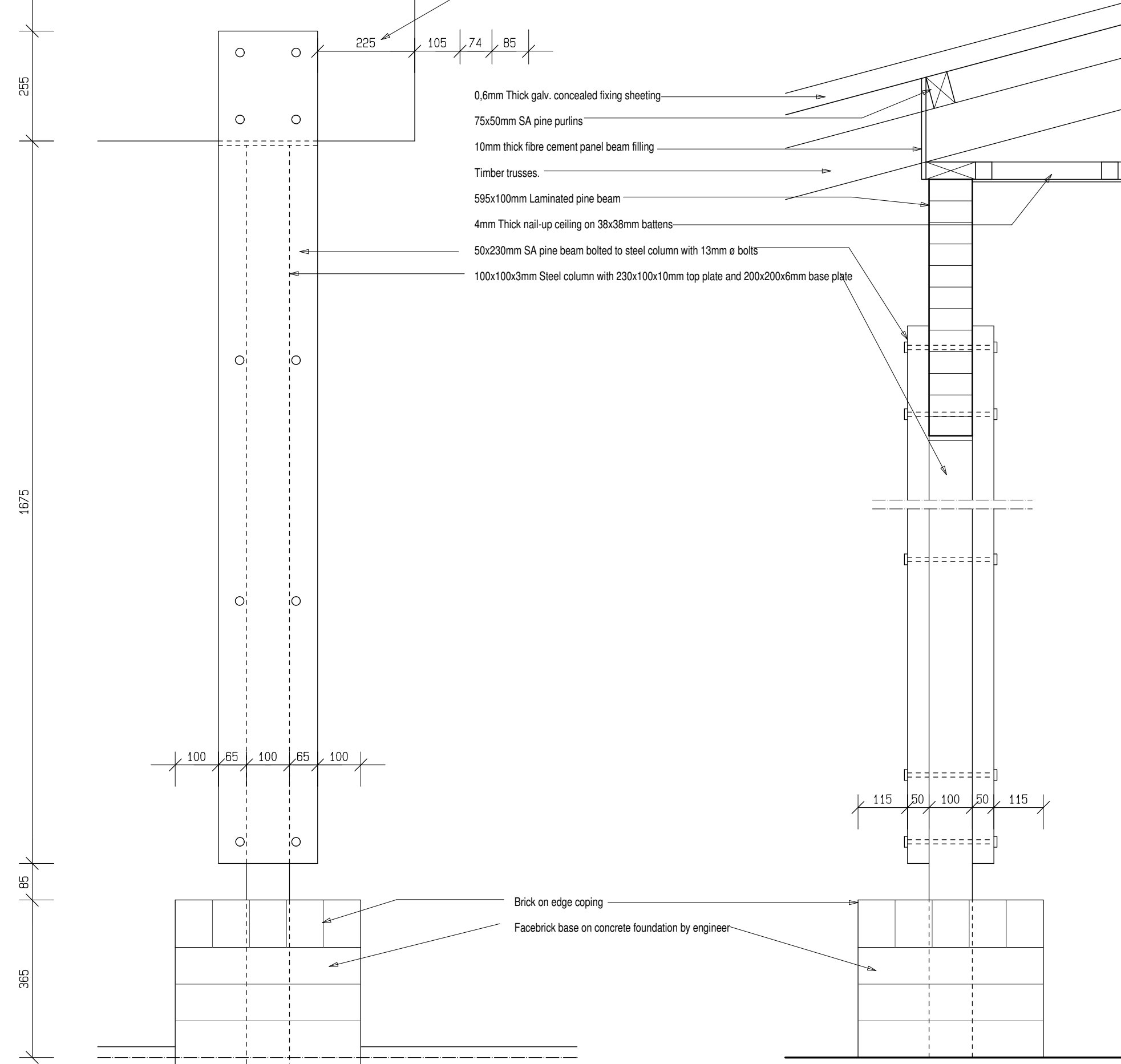
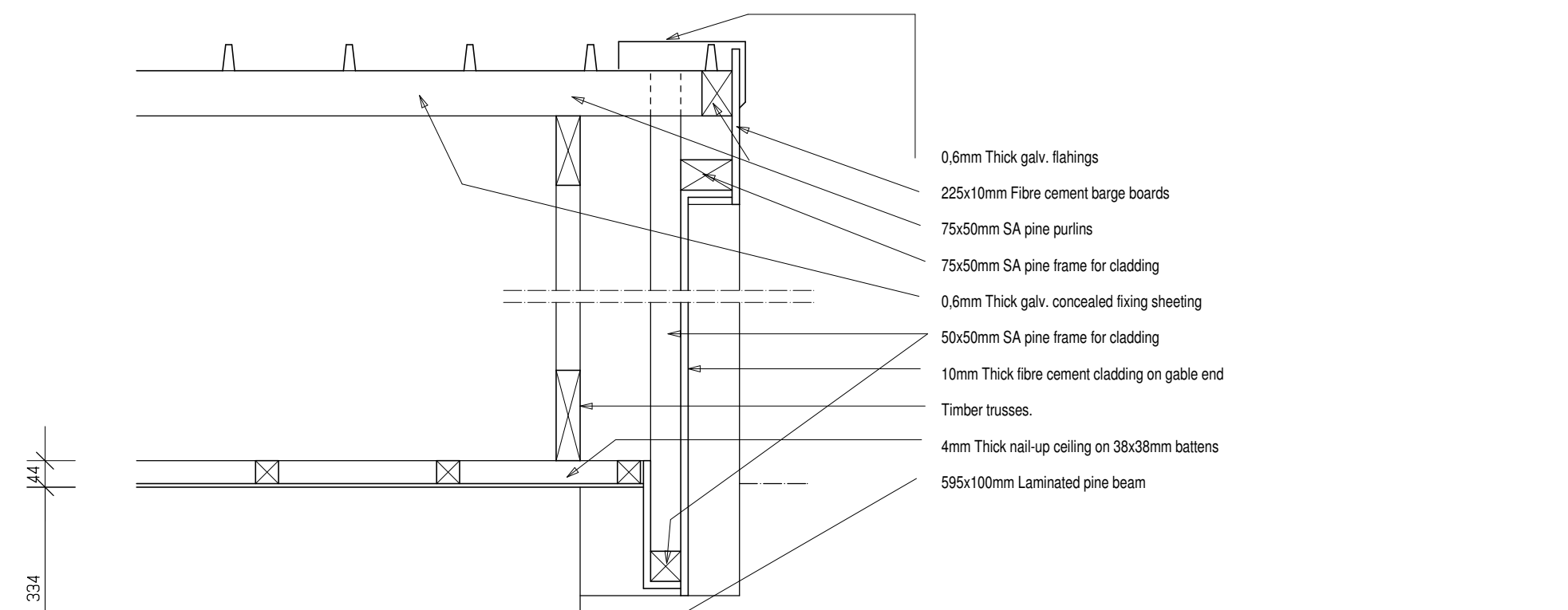

1:20 ST DETAIL 3  
TOILET DUCT: SIDE ELEVATION

1:20 ST DETAIL 3  
TOILET DUCT: FRONT ELEVATION

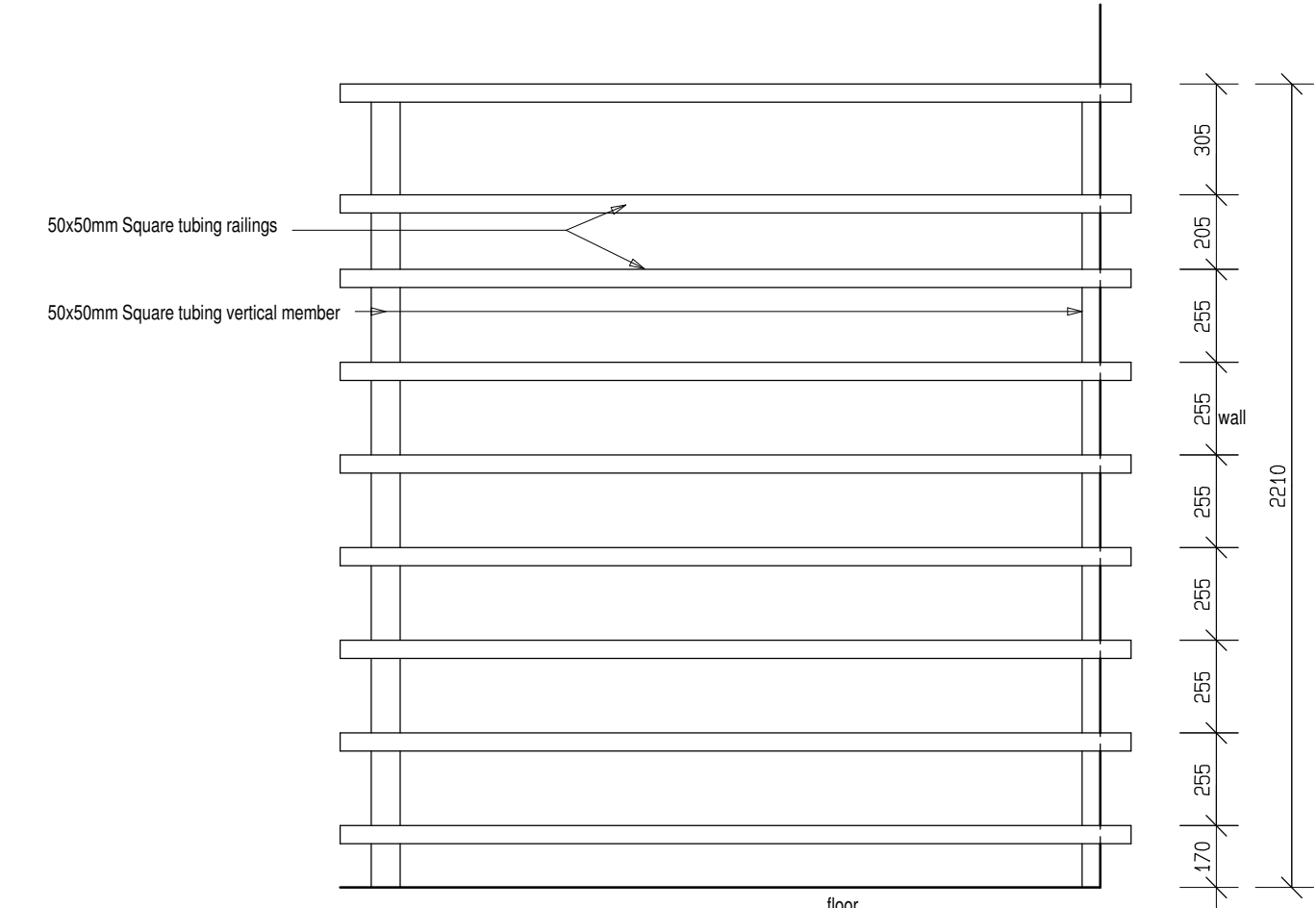

1:20 ST DETAIL 4  
WATERTANK ENCLOSURE  
ON SIDES: SIDE ELEVATION

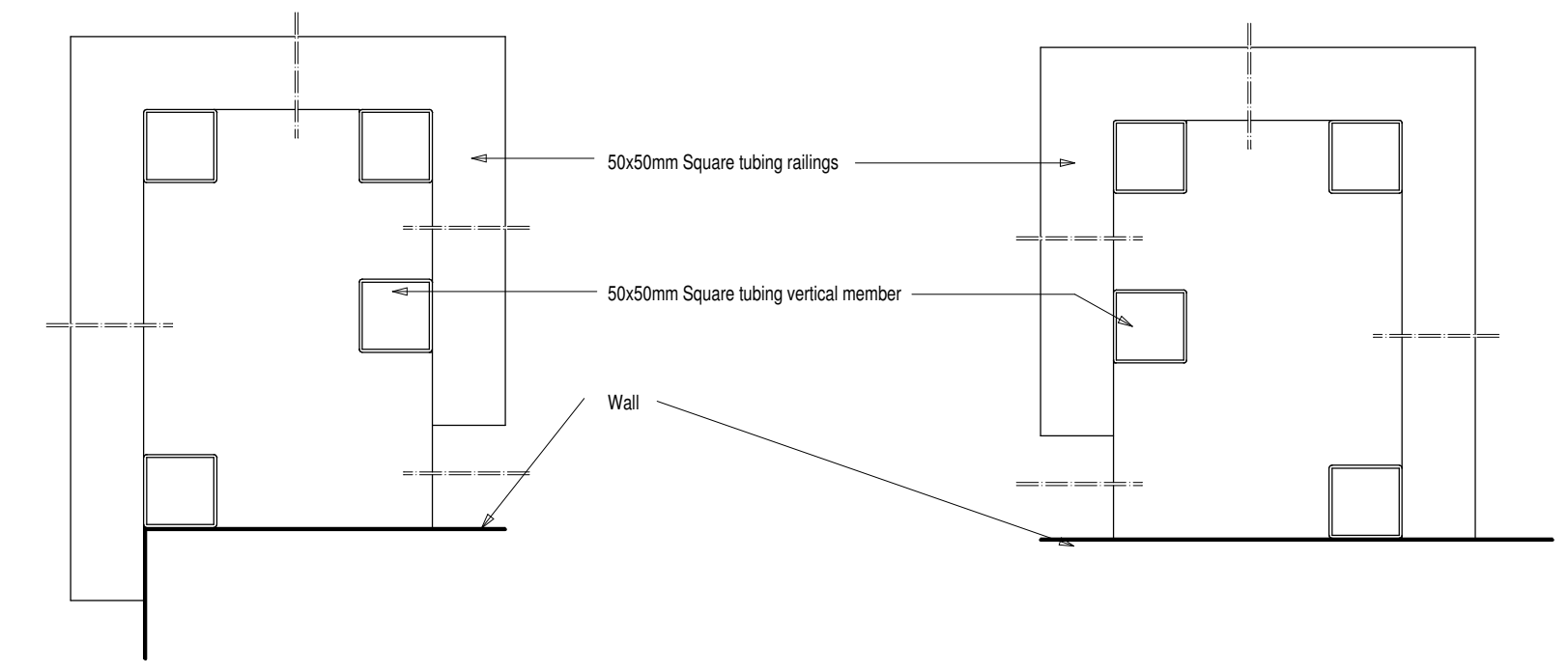

1:20 ST DETAIL 4B

1:20 ST DETAIL 5A

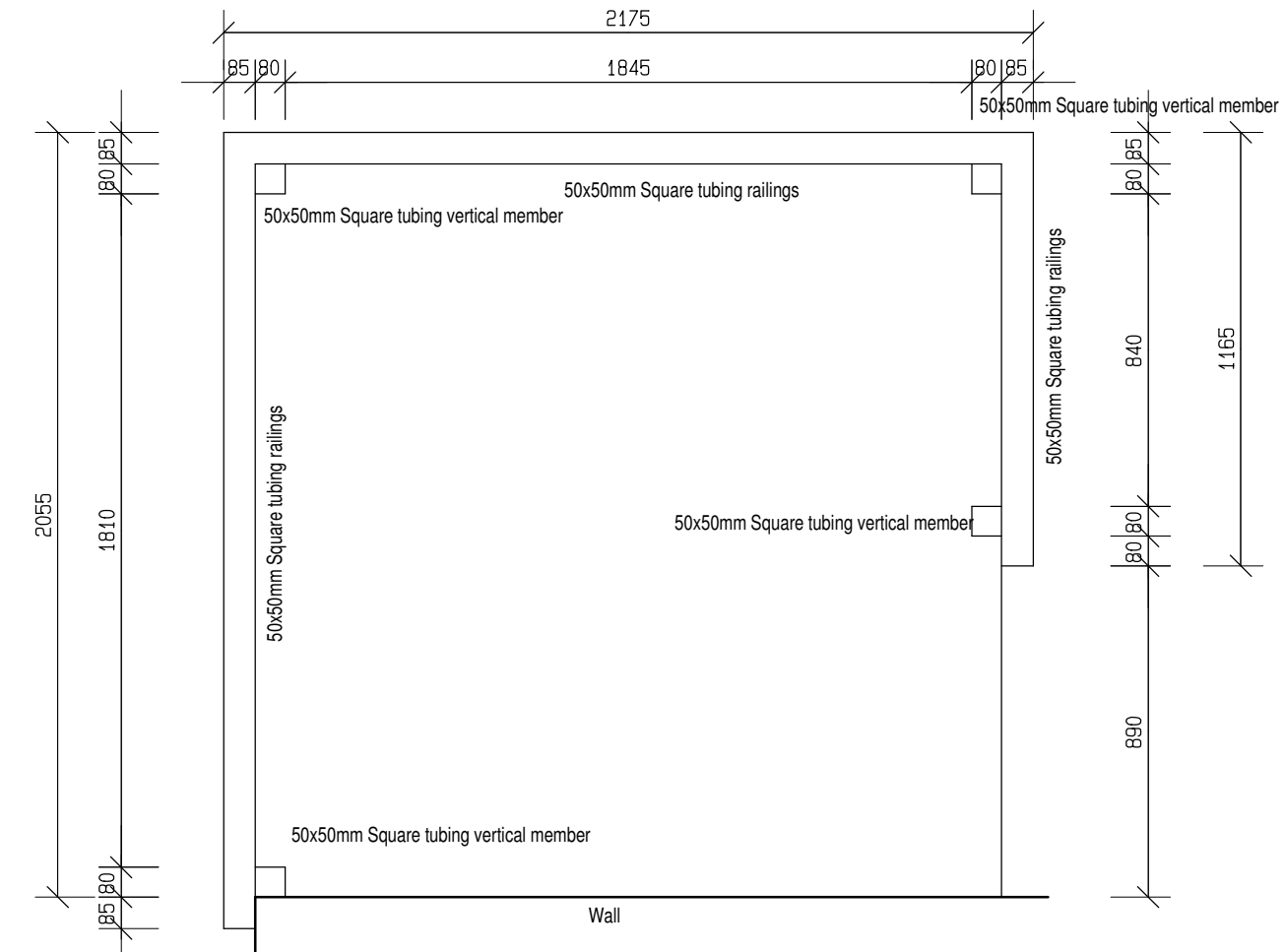

1:20 ST DETAIL 4  
WATERTANK ENCLOSURE  
ON SIDES: PLAN

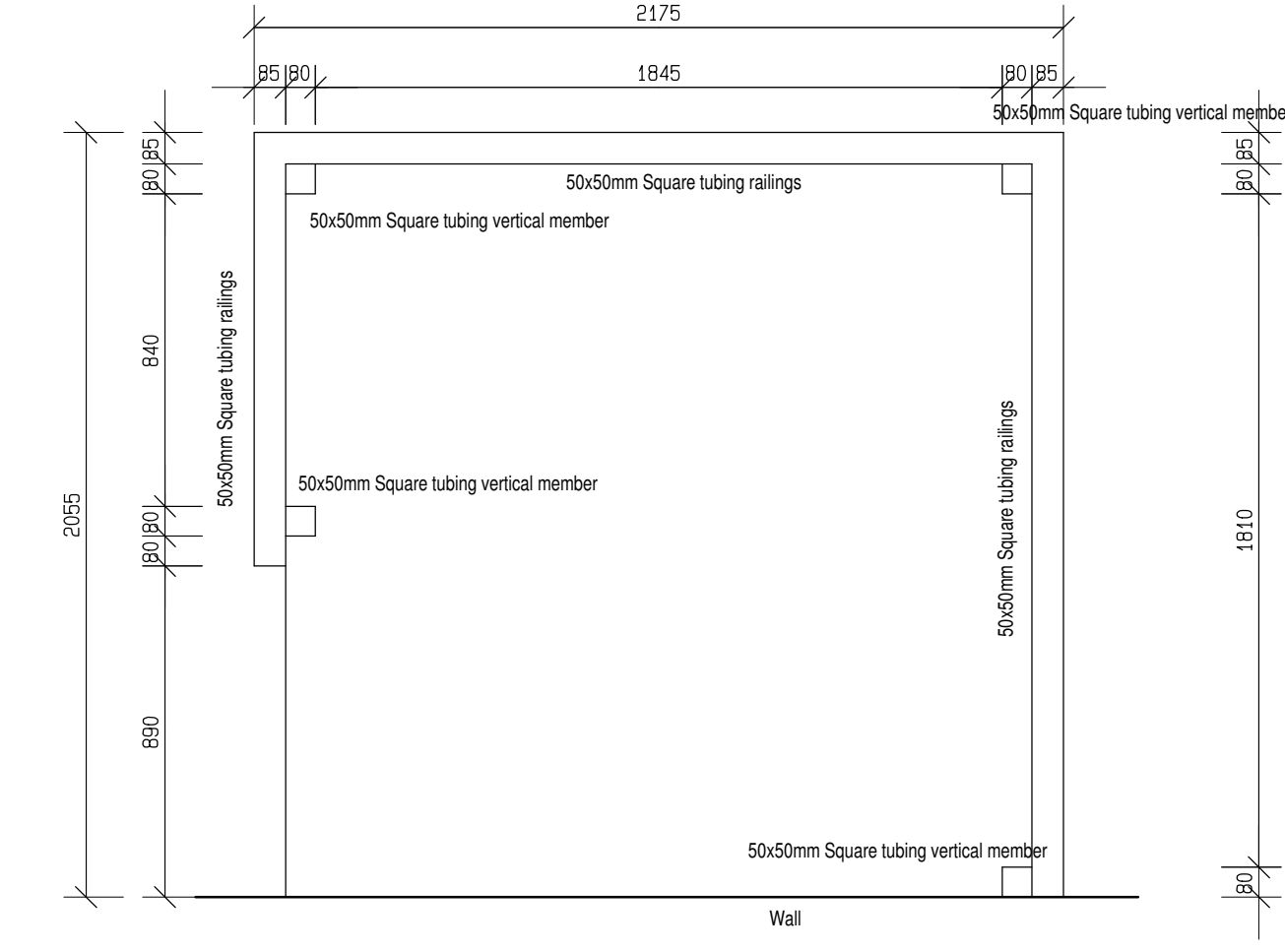

1:20 ST DETAIL 5  
WATERTANK ENCLOSURE  
CENTRE: PLAN

REVISION	DRAWN	DATE	REV NO.
WYSIGING	GETEKEN	DATUM	WYS NR.
PROJECT			PROJEK
STANDARD TRIBAL OFFICE for THE DEPARTMENT of TRADITIONAL AFFAIRS			
DRAWING			TEKENING
STRUCTURAL DETAILS			
SCALE	1:50	DRAWN	D.C.
SKAAL		GETEKEN	
DATE	2018/01/17	CHECKED	D.C.
CLIENT NO.			KLIJENT NR.
PROJECT NO.	STAGE	DRAWING NO.	REVISION
LDPWRI	3	TO 1.4	
PROJEK NR.	PROBAB	TEKENING NR.	WYSIGING

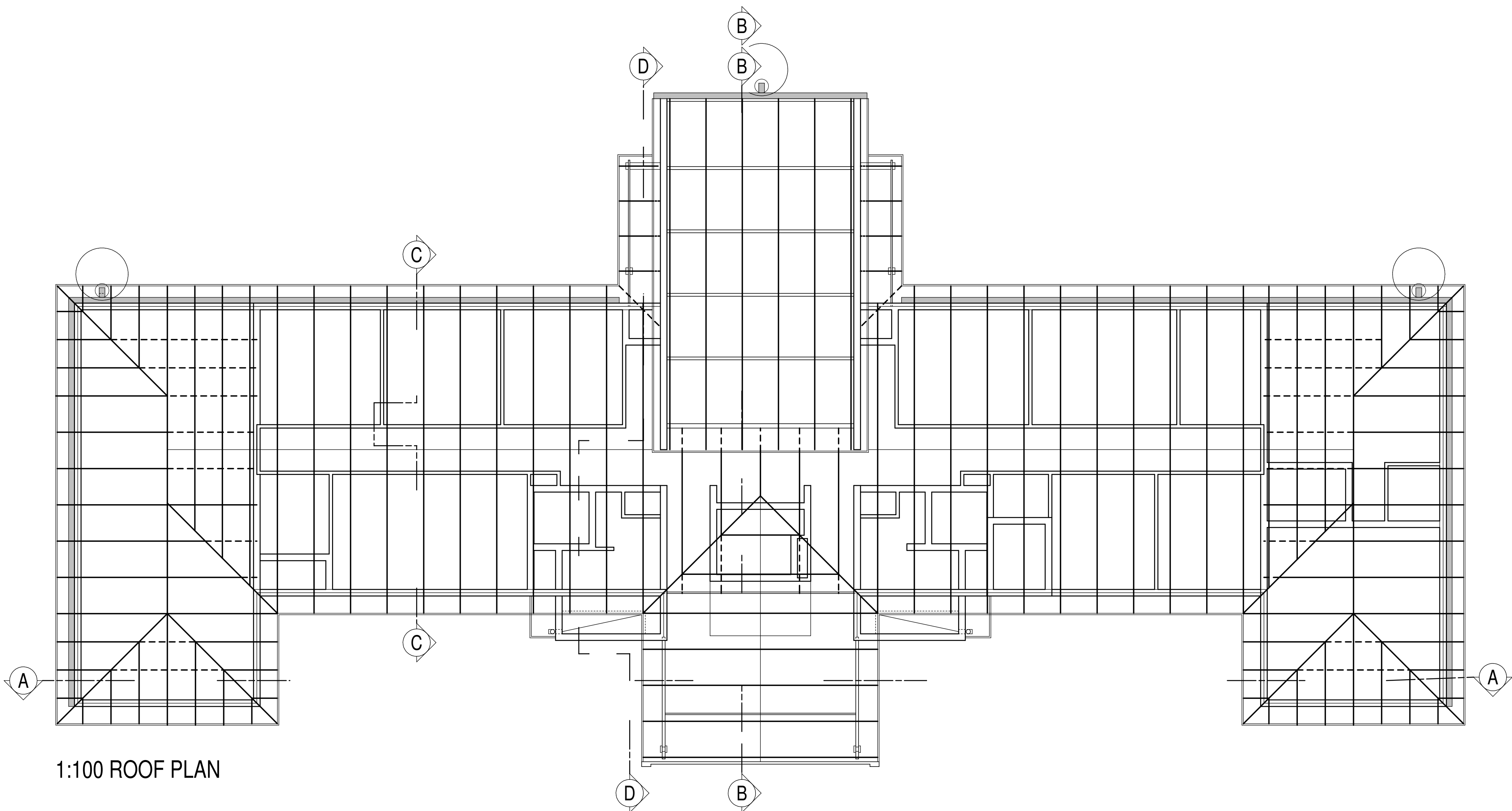
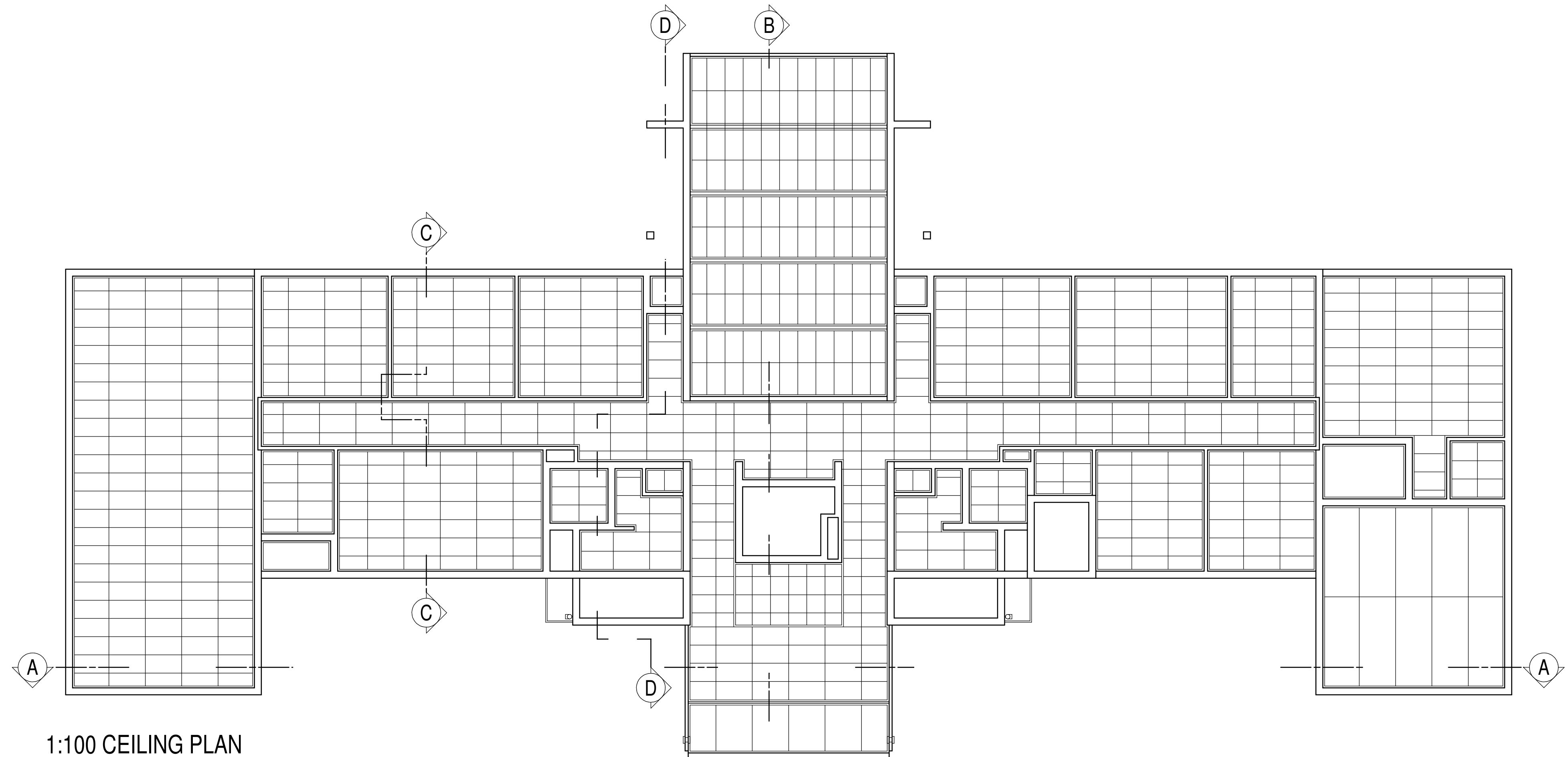

REVISION	DRAWN	DATE	REV NO.
WYSIGING	GETEKEN	DATUM	WYS NR.
PROJECT		PROJEK	
<b>STANDARD TRIBAL OFFICE</b> for THE DEPARTMENT of TRADITIONAL AFFAIRS			
DRAWING		TEKENING	
<b>ROOF PLAN</b> <b>CEILING PLAN</b>			
SCALE	1:100	DRAWN	D.C.
SKAAL		GETEKEN	
DATE	2018/01/17	CHECKED	D.C.
CLIENT NO.		CLIENT NR.	
PROJECT NO.	LDPWRI	STAGE	3
		DRAWING NO.	TO 1.5
REVISION			
PROJEK NR.	PROBAB	TEKENING NR.	WYSIGING

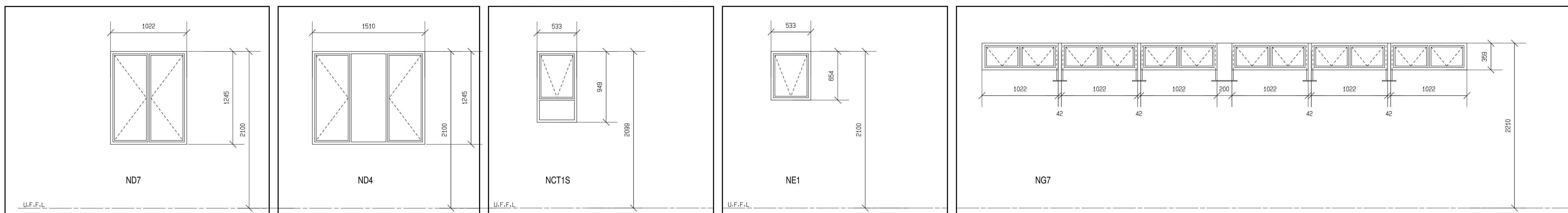

WINDOW NO.	W1	W2	W3	W4	W5
<b>FRAME DESCRIPTION</b>	STANDARD ND7 RESIDENTIAL MILD STEEL WINDOW FRAME WITH SIDE HUNG OPENING SECTIONS OPENING OUTWARDS.	STANDARD ND4 RESIDENTIAL MILD STEEL WINDOW FRAME WITH SIDE HUNG OPENING SECTIONS OPENING OUTWARDS.	STANDARD NCT1S RESIDENTIAL MILD STEEL WINDOW FRAME WITH TOP HUNG OPENING SECTION OPENING OUTWARDS.	STANDARD NE1 RESIDENTIAL MILD STEEL WINDOW FRAME WITH TOP HUNG OPENING SECTION OPENING OUTWARDS.	STANDARD NG7 RESIDENTIAL MILD STEEL WINDOW FRAME WITH TOP HUNG OPENING SECTION OPENING OUTWARDS. CONNECTED WITH 25mm THICK SPACER WIDTH TO PROVIDE GAP AS INDICATED.
<b>FRAME FINISHING</b>	TOUCH UP PRIMER, APPLY ONE COAT UNIVERSAL UNDERCOAT AND TWO COATS POLYURETHANE SEMI-GLOSS ENAMEL. SANDPAPER LIGHTLY BETWEEN COATS. COLOUR ACCORDING TO ARCHITECT.	TOUCH UP PRIMER, APPLY ONE COAT UNIVERSAL UNDERCOAT AND TWO COATS POLYURETHANE SEMI-GLOSS ENAMEL. SANDPAPER LIGHTLY BETWEEN COATS. COLOUR ACCORDING TO ARCHITECT.	TOUCH UP PRIMER, APPLY ONE COAT UNIVERSAL UNDERCOAT AND TWO COATS POLYURETHANE SEMI-GLOSS ENAMEL. SANDPAPER LIGHTLY BETWEEN COATS. COLOUR ACCORDING TO ARCHITECT.	TOUCH UP PRIMER, APPLY ONE COAT UNIVERSAL UNDERCOAT AND TWO COATS POLYURETHANE SEMI-GLOSS ENAMEL. SANDPAPER LIGHTLY BETWEEN COATS. COLOUR ACCORDING TO ARCHITECT.	TOUCH UP PRIMER, APPLY ONE COAT UNIVERSAL UNDERCOAT AND TWO COATS POLYURETHANE SEMI-GLOSS ENAMEL. SANDPAPER LIGHTLY BETWEEN COATS. COLOUR ACCORDING TO ARCHITECT.
<b>FITTINGS</b>	STANDARD FITTINGS AS SUPPLIED WITH FRAMES.	STANDARD FITTINGS AS SUPPLIED WITH FRAMES.	STANDARD FITTINGS AS SUPPLIED WITH FRAMES.	STANDARD FITTINGS AS SUPPLIED WITH FRAMES.	STANDARD FITTINGS AS SUPPLIED WITH FRAMES.
<b>GLAZING</b>	4 mm THICK CLEAR FLOAT GLASS FITTED IN PUTTY.	4 mm THICK CLEAR FLOAT GLASS FITTED IN PUTTY.	4 mm THICK OBSCURE GLASS FITTED IN PUTTY.	4 mm THICK OBSCURE GLASS FITTED IN PUTTY.	4 mm THICK OBSCURE GLASS FITTED IN PUTTY.
<b>BURG. PROOF AND GAUZE</b>	10mm DIA. HORIZONTAL STEEL BURGLAR BARS AT 150mm CENTRES. PAINT AS FOR FRAME.	10mm DIA. HORIZONTAL STEEL BURGLAR BARS AT 150mm CENTRES. PAINT AS FOR FRAME.	10mm DIA. HORIZONTAL STEEL BURGLAR BARS AT 150mm CENTRES. PAINT AS FOR FRAME.	10mm DIA. HORIZONTAL STEEL BURGLAR BARS AT 150mm CENTRES. PAINT AS FOR FRAME.	10mm DIA. HORIZONTAL STEEL BURGLAR BARS AT 150mm CENTRES. PAINT AS FOR FRAME.

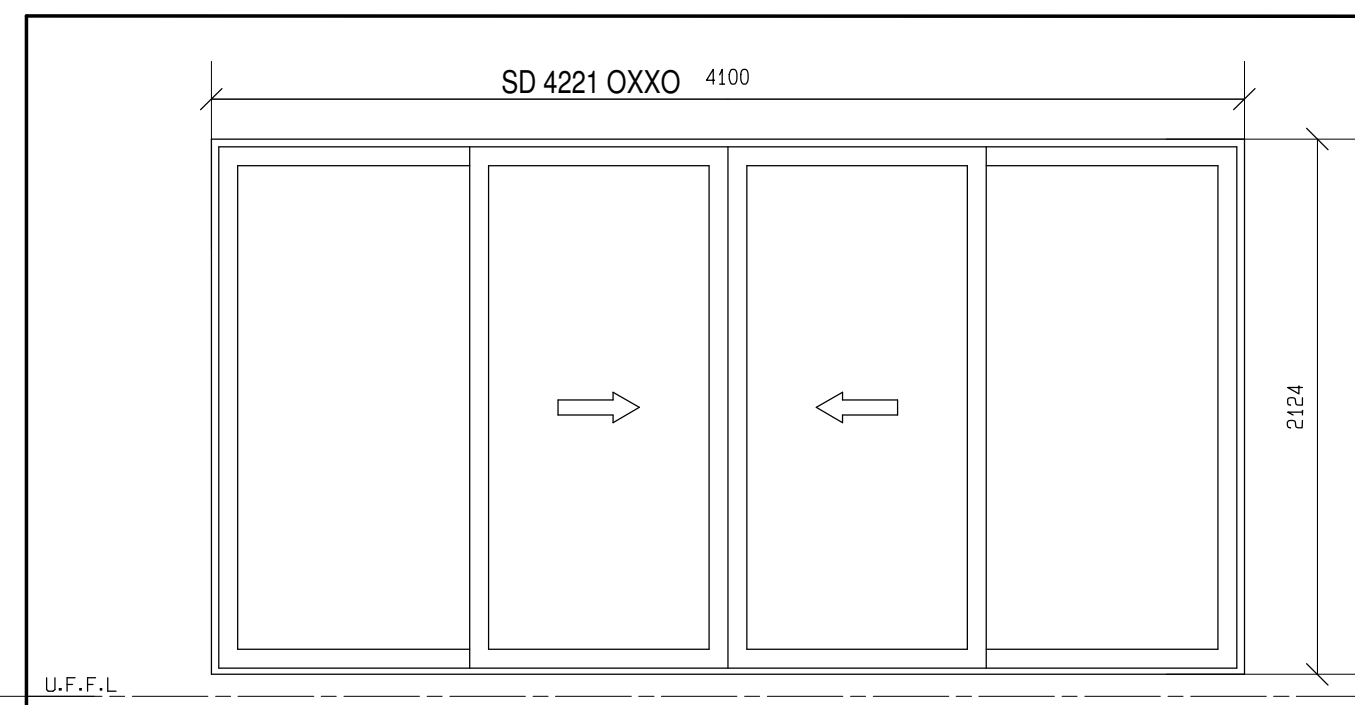
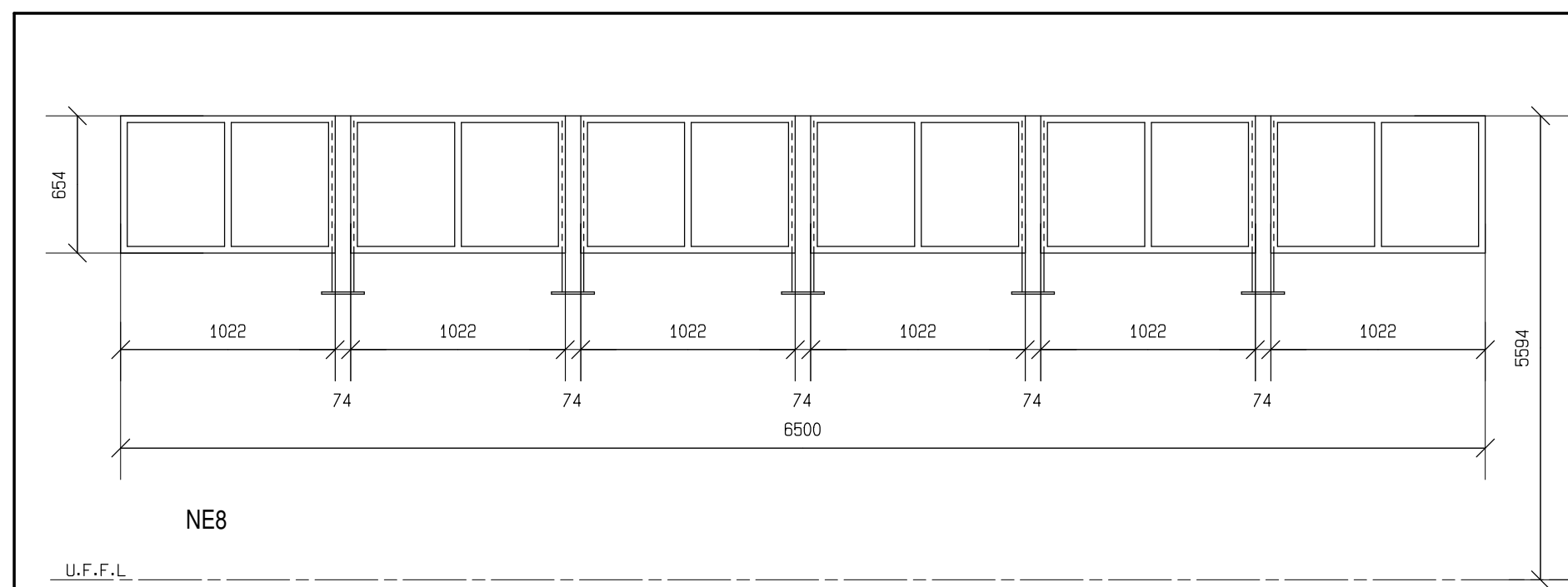

WINDOW NO.	W6	NUMBER REQD.	W7	NUMBER REQD.
<b>FRAME DESCRIPTION</b>	STANDARD ZNE1 RESIDENTIAL MILD STEEL WINDOW FRAME WITH TOP HUNG SECTION OPENING OUTWARDS.			
<b>FRAME FINISHING</b>	REMOVE EXISTING GLASS. SAND DOWN EXISTING PAINT. APPLY ONE COAT UNIVERSAL UNDERCOAT AND TWO COATS POLYURETHANE SEMI-GLOSS ENAMEL. SANDPAPER LIGHTLY BETWEEN COATS. COLOUR ACCORDING TO ARCHITECT.			
<b>FITTINGS</b>	EXISTING. REPLACE IF DEFECTIVE.			
<b>GLAZING</b>	REMOVE EXISTING SAFETY GLASS. REPLACE WITH 4 mm THICK CLEAR FLOAT GLASS FITTED IN PUTTY.			
<b>BURG. PROOF AND GAUZE</b>	EXISTING STEEL BURGLAR PROOFING. PAINT AS FOR FRAME.			

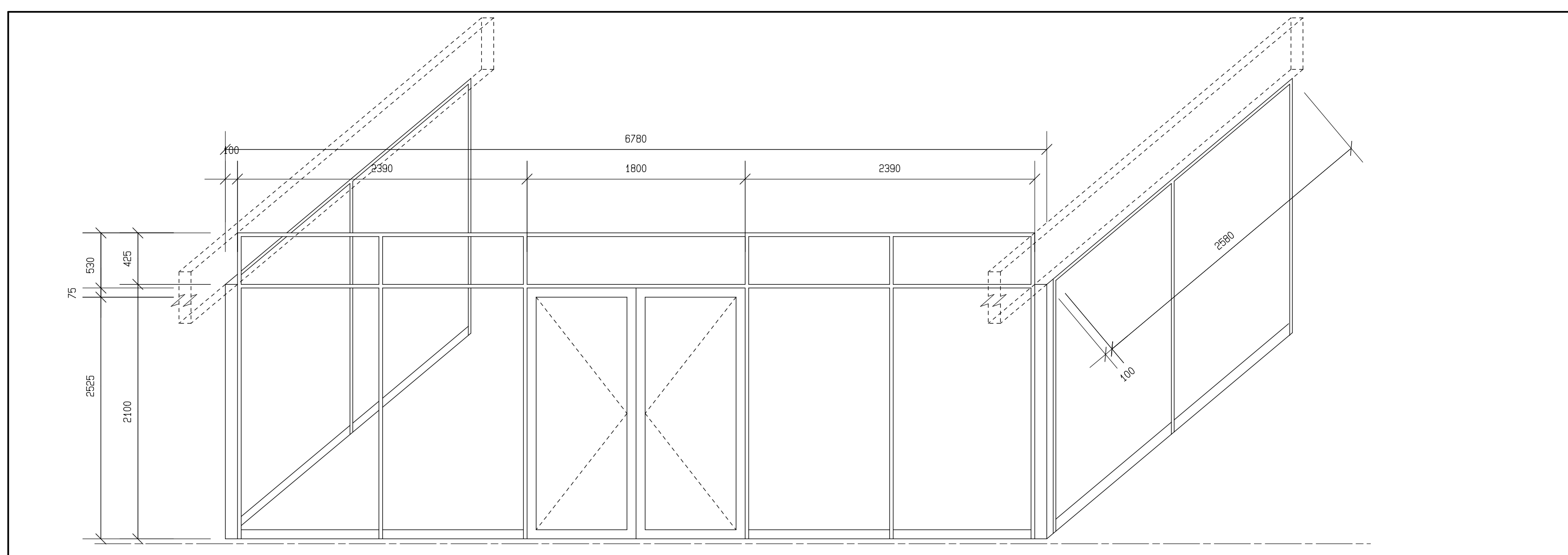

WINDOW NO.	W8	NUMBER REQD.
<b>FRAME DESCRIPTION</b>	STANDARD ZNE1 RESIDENTIAL MILD STEEL WINDOW FRAME WITH TOP HUNG SECTION OPENING OUTWARDS.	
<b>FRAME FINISHING</b>	REMOVE EXISTING GLASS. SAND DOWN EXISTING PAINT. APPLY ONE COAT UNIVERSAL UNDERCOAT AND TWO COATS POLYURETHANE SEMI-GLOSS ENAMEL. SANDPAPER LIGHTLY BETWEEN COATS. COLOUR ACCORDING TO ARCHITECT.	
<b>FITTINGS</b>	EXISTING. REPLACE IF DEFECTIVE.	
<b>GLAZING</b>	REMOVE EXISTING SAFETY GLASS. REPLACE WITH 4 mm THICK CLEAR FLOAT GLASS FITTED IN PUTTY.	
<b>BURG. PROOF AND GAUZE</b>	EXISTING STEEL BURGLAR PROOFING. PAINT AS FOR FRAME.	

REVISION	DRAWN	DATE	REV. NO.
WYSIGING	GETEKEN	DA/TUM	WYS. NR.
PROJECT		PROJEK	
<b>STANDARD TRIBAL OFFICE for THE DEPARTMENT of TRADITIONAL AFFAIRS</b>			
DRAWING		TEKENING	
<b>WINDOW SCHEDULE</b>			
SCALE	DRAWN	D.C.	
SKAAL	GETEKEN	D.C.	
DATE	CHECKED	D.C.	
2018/01/17			
CLIENT NO.	KLIJENT NR.		
PROJECT NO.	STAGE	DRAWING NO.	REVISION
LDPWRI	3	TO 1.6	
PROJEK NR.	PROBAB	TEKENING NR.	WYSIGING

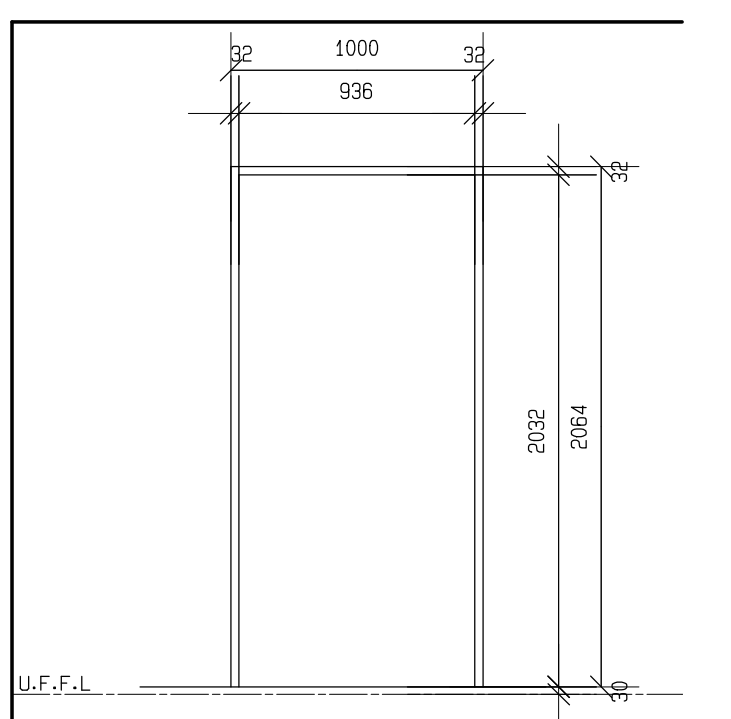
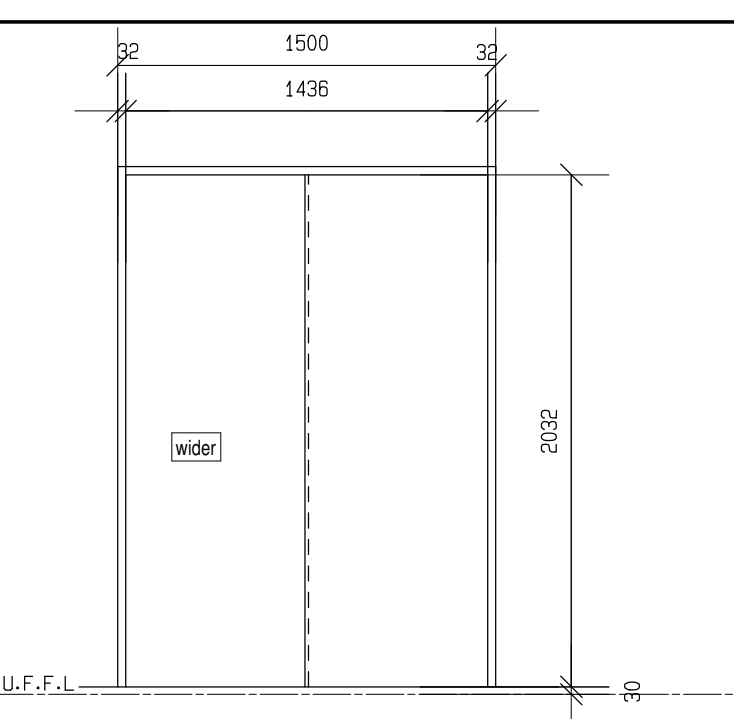
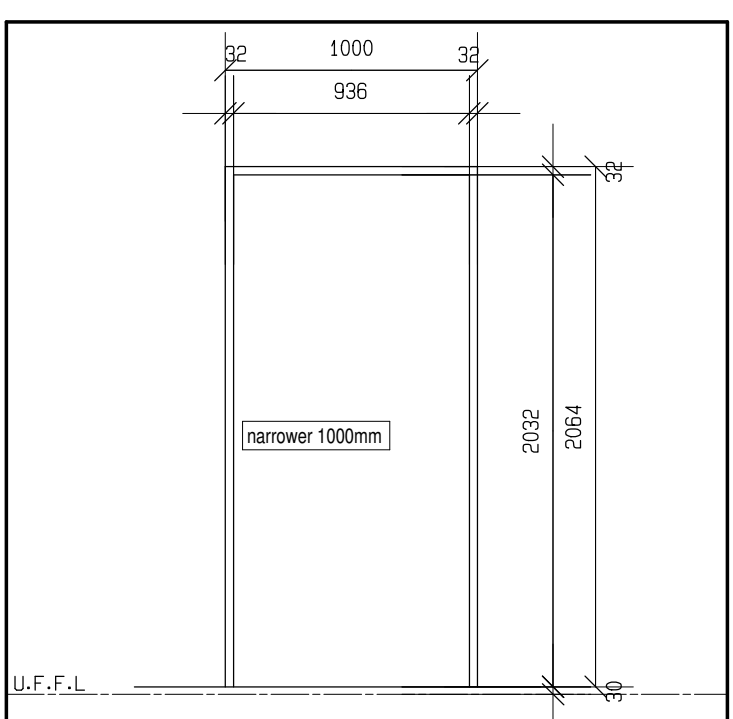
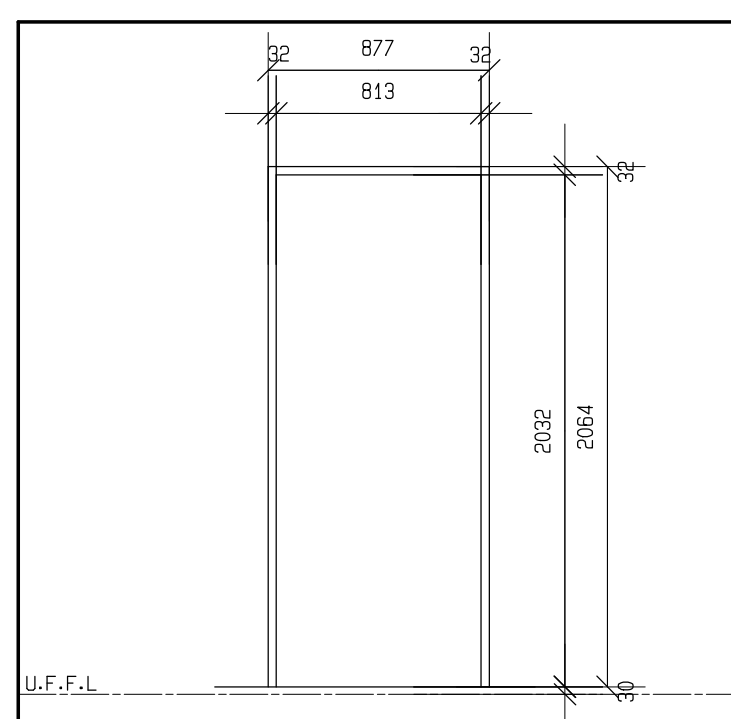
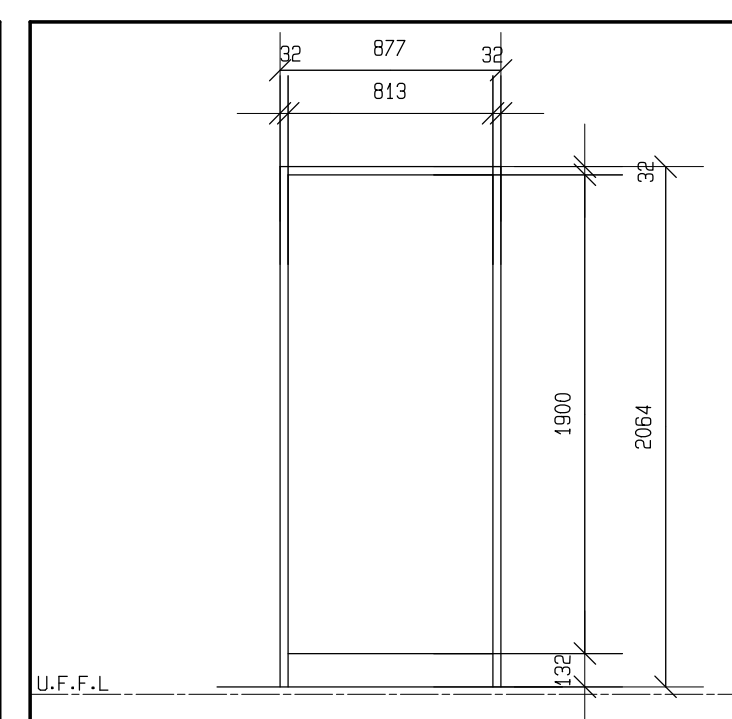
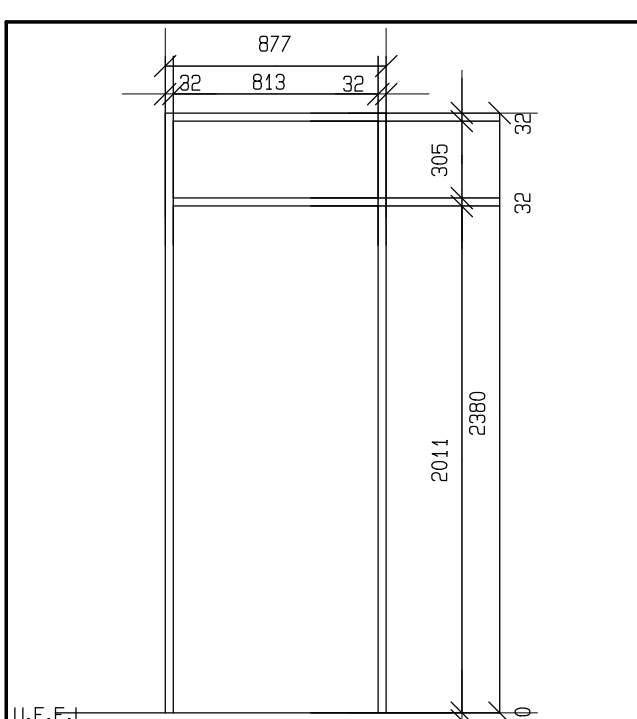
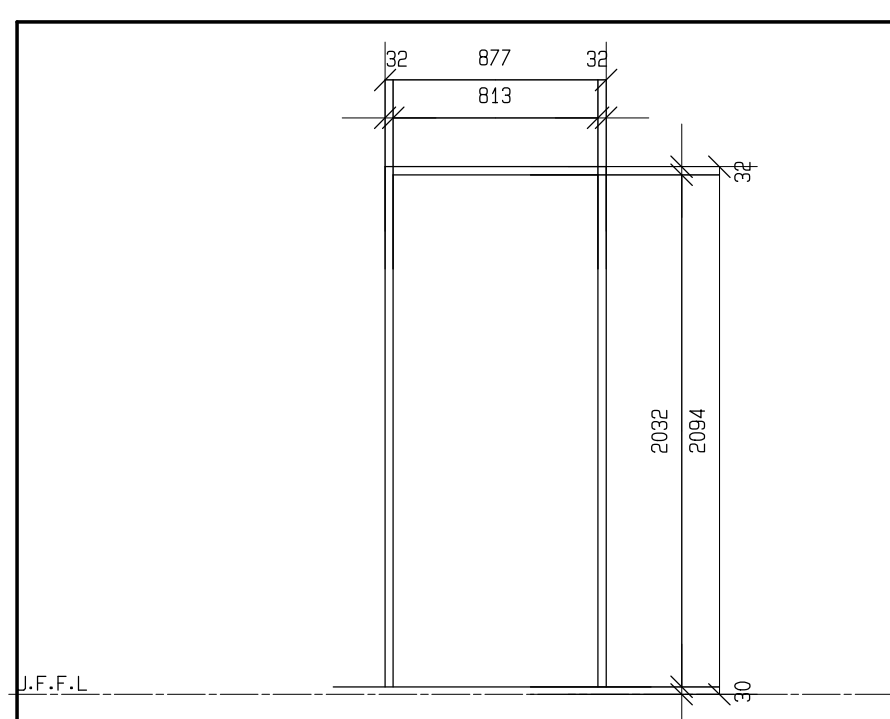

DOOR NO.	D1	NUMBER REQD.
FRAME DESCRIPTION	EXISTING STANDARD 1,2mm THICK SINGLE REBATE MILD STEEL DOOR FRAME COMPLETE WITH ONE PAIR STANDARD BUTT HINGES. FOR 115mm OR 230mm WALL.	
FRAME FINISHING	SAND DOWN EXISTING FRAME AND APPLY COATS POLYURETHANE ENAMEL. SANDPAPER LIGHTLY BETWEEN COATS. COLOUR ACC. TO ARCHITECT.	
DOOR DESCRIPTION	NEW 2032x813x40mm THICK SEMI-SOLID CORE DOOR WITH 3mm THICK TEMPERED HARDBOARD SIDES AND CONCEALED HARDWOOD EDGES.	
DOOR FINISHING	PREPARE AND CLEAN. APPLY ONE COAT WOOD PRIMER AND TWO COATS POLYURETHANE VELVET ENAMEL. SANDPAPER LIGHTLY BETWEEN COATS. COLOUR ACC. TO ARCHITECT.	
FANLIGHT	NONE.	
IRONMONGERY AND SUNDRIES	SEE SPECIFICATION.	

DOOR NO.	D2	NUMBER REQD.
FRAME DESCRIPTION	EXISTING STANDARD 1,2mm THICK SINGLE REBATE MILD STEEL DOOR FRAME COMPLETE WITH ONE PAIR STANDARD BUTT HINGES. FOR 115mm OR 230mm WALL.	
FRAME FINISHING	SAND DOWN EXISTING FRAME AND APPLY COATS POLYURETHANE ENAMEL. SANDPAPER LIGHTLY BETWEEN COATS. COLOUR ACCORDING TO ARCHITECT.	
DOOR DESCRIPTION	NEW 2032x813x40mm THICK SEMI-SOLID CORE DOOR WITH 3mm THICK TEMPERED HARDBOARD SIDES AND CONCEALED HARDWOOD EDGES.	
DOOR FINISHING	PREPARE AND CLEAN. APPLY ONE COAT WOOD PRIMER AND TWO COATS POLYURETHANE VELVET ENAMEL. SANDPAPER LIGHTLY BETWEEN COATS. COLOUR ACC. TO ARCHITECT.	
FANLIGHT	4mm THICK FLOAT GLASS IN PUTTY IN FRAME.	
IRONMONGERY AND SUNDRIES	SEE SPECIFICATION.	

DOOR NO.	D3	NUMBER REQD.
FRAME DESCRIPTION	EXISTING STANDARD 1,2mm THICK SINGLE REBATE MILD STEEL DOOR FRAME COMPLETE WITH ONE PAIR STANDARD BUTT HINGES. FOR 115mm WALL.	
FRAME FINISHING	SAND DOWN EXISTING FRAME AND APPLY COATS POLYURETHANE ENAMEL. SANDPAPER LIGHTLY BETWEEN COATS. COLOUR ACCORDING TO ARCHITECT.	
DOOR DESCRIPTION	NEW 1900x813x40mm THICK SEMI-SOLID CORE DOOR WITH 3mm THICK TEMPERED HARDBOARD SIDES AND CONCEALED HARDWOOD EDGES. GAP OF 1032mm AT BOTTOM.	
DOOR FINISHING	PREPARE AND CLEAN. APPLY ONE COAT WOOD PRIMER AND TWO COATS POLYURETHANE VELVET ENAMEL. SANDPAPER LIGHTLY BETWEEN COATS. COLOUR ACCORDING TO ARCHITECT.	
FANLIGHT	NONE.	
IRONMONGERY AND SUNDRIES	SEE SPECIFICATION.	

DOOR NO.	D4	NUMBER REQD.
FRAME DESCRIPTION	EXISTING STANDARD 1,2mm THICK SINGLE REBATE MILD STEEL DOOR FRAME COMPLETE WITH ONE PAIR STANDARD BUTT HINGES FOR 345mm WALL. STEEL GATE OPENING OUTWARD.	
FRAME FINISHING	SAND DOWN EXISTING FRAME AND APPLY COATS POLYURETHANE ENAMEL. SANDPAPER LIGHTLY BETWEEN COATS. COLOUR ACCORDING TO ARCHITECT.	
DOOR DESCRIPTION	NEW 2032x813x40mm THICK SOLID CORE DOOR WITH 3mm THICK TEMPERED HARDBOARD SIDES AND CONCEALED HARDWOOD EDGES.	
DOOR FINISHING	PREPARE AND CLEAN. APPLY ONE COAT WOOD PRIMER AND TWO COATS POLYURETHANE VELVET ENAMEL. SANDPAPER LIGHTLY BETWEEN COATS. COLOUR ACCORDING TO ARCHITECT.	
FANLIGHT	NONE.	
IRONMONGERY AND SUNDRIES	SEE SPECIFICATION.	

DOOR NO.	D5	NUMBER REQD.
FRAME DESCRIPTION	EXISTING STANDARD 1,2mm THICK SINGLE REBATE MILD STEEL DOOR FRAME COMPLETE WITH ONE PAIR STANDARD BUTT HINGES FOR 345mm WALL.	
FRAME FINISHING	SAND DOWN EXISTING FRAME AND APPLY COATS POLYURETHANE ENAMEL. SANDPAPER LIGHTLY BETWEEN COATS. COLOUR ACCORDING TO ARCHITECT.	
DOOR DESCRIPTION	NEW 1000x813x40mm THICK SOLID CORE DOOR WITH 3mm THICK TEMPERED HARDBOARD SIDES AND CONCEALED HARDWOOD EDGES.	
DOOR FINISHING	PREPARE AND CLEAN. APPLY ONE COAT WOOD PRIMER AND TWO COATS POLYURETHANE VELVET ENAMEL. SANDPAPER LIGHTLY BETWEEN COATS. COLOUR ACCORDING TO ARCHITECT.	
FANLIGHT	NONE.	
IRONMONGERY AND SUNDRIES	SEE SPECIFICATION.	

DOOR NO.	D6	NUMBER REQD.
FRAME DESCRIPTION	EXISTING STANDARD 1,2mm THICK SINGLE REBATE MILD DOUBLE STEEL DOOR FRAME COMPLETE WITH ONE PAIR STANDARD BUTT HINGES. FOR 230mm WALL.	
FRAME FINISHING	SAND DOWN EXISTING FRAME AND APPLY COATS POLYURETHANE ENAMEL. SANDPAPER LIGHTLY BETWEEN COATS. COLOUR ACCORDING TO ARCHITECT.	
DOOR DESCRIPTION	NEW 2032x1500x40mm THICK SOLID CORE DOUBLE DOORS WITH 3mm THICK TEMPERED HARDBOARD SIDES AND CONCEALED HARDWOOD EDGES AND REBATED SLAMMING STYLES.	
DOOR FINISHING	PREPARE AND CLEAN. APPLY ONE COAT WOOD PRIMER AND TWO COATS POLYURETHANE VELVET ENAMEL. SANDPAPER LIGHTLY BETWEEN COATS. COLOUR ACCORDING TO ARCHITECT.	
FANLIGHT	VIEWING PANEL 300x300mm with 13mm WOOD GLAZING BEADS. 4mm FLOAT GLASS IN PUTTY IN FANLIGHT.	
IRONMONGERY AND SUNDRIES	SEE SPECIFICATION.	

DOOR NO.	D7	NUMBER REQD.
FRAME DESCRIPTION	NONE.	
FRAME FINISHING	NO ACTION.	
DOOR DESCRIPTION	NEW 2032x1000x40mm THICK SOLID CORE DOOR WITH 3mm THICK TEMPERED HARDBOARD SIDES AND CONCEALED HARDWOOD EDGES. SUSPENDED FROM EXISTING SLIDING MECHANISM.	
DOOR FINISHING	PREPARE AND CLEAN. APPLY ONE COAT WOOD PRIMER AND TWO COATS POLYURETHANE VELVET ENAMEL. SANDPAPER LIGHTLY BETWEEN COATS. COLOUR ACCORDING TO ARCHITECT.	
FANLIGHT	NONE.	
IRONMONGERY AND SUNDRIES	SEE SPECIFICATION.	

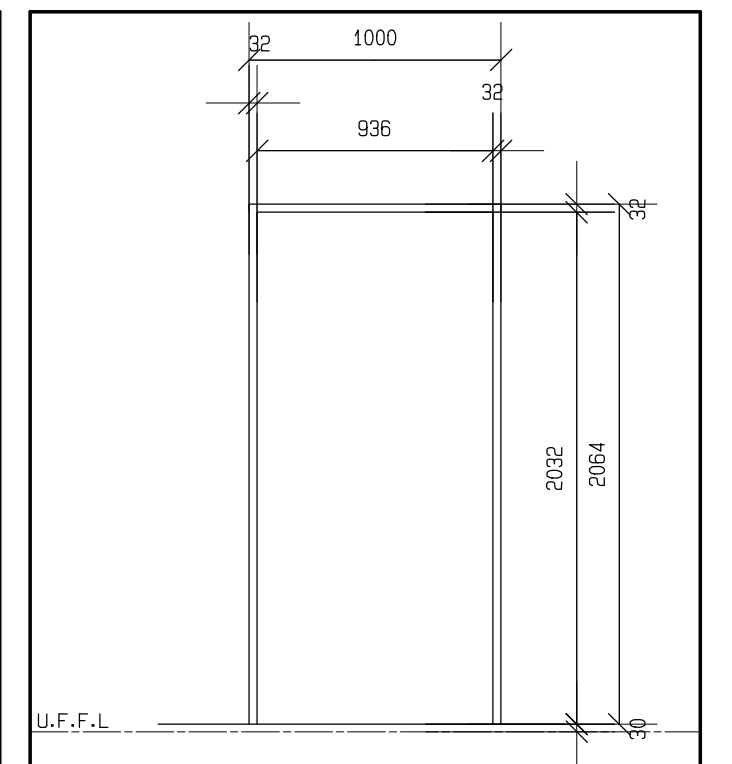
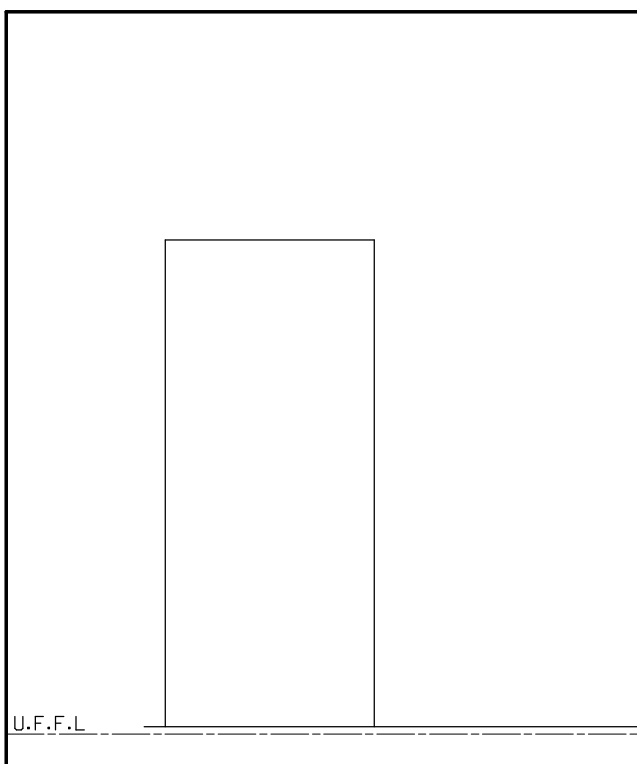
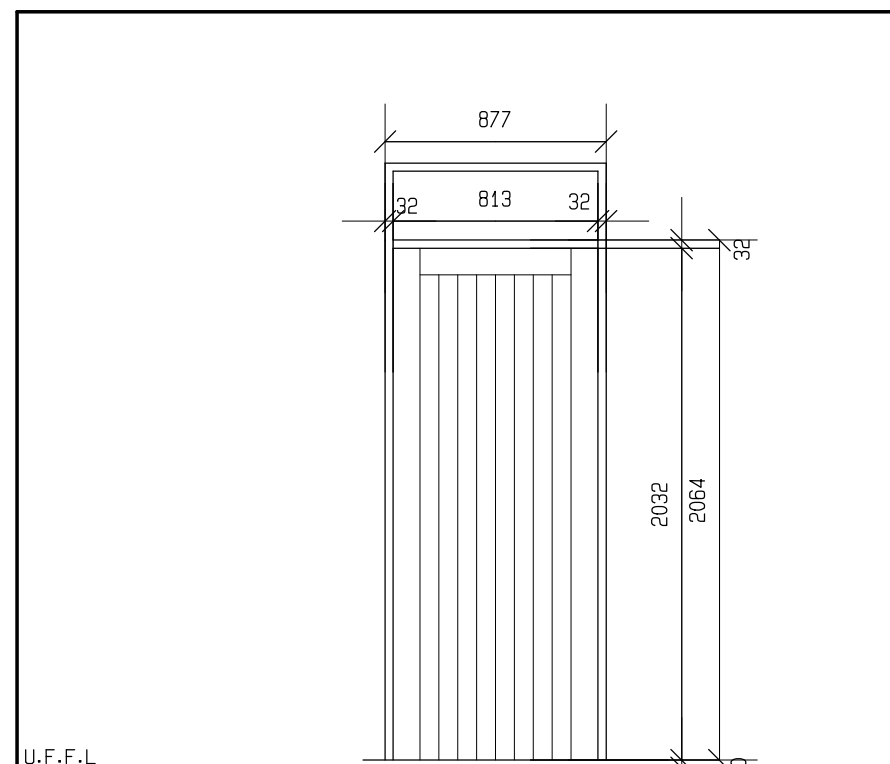

DOOR NO.	D8	NUMBER REQD.
FRAME DESCRIPTION	STANDARD 1,2mm THICK SINGLE REBATED MILD STEEL DOOR FRAME FOR 230mm WALL. FRAME COMPLETE WITH ONE PAIR STANDARD BUTT HINGES.	
FRAME FINISHING	SAND DOWN. APPLY TWO COATS POLYURETHANE ENAMEL. SAND PAPER LIGHTLY BETWEEN COATS. COLOUR ACCORDING TO ARCHITECT.	
DOOR DESCRIPTION	2032x813x40mm THICK TAG FRAMED LEDGED AND BATTEN MERANTI DOOR WITH REBATE FLUSH PANEL INSIDE. SUPPLY STANDARD WEATHER BAR.	
DOOR FINISHING	INTERNAL: PREPARE AND CLEAN. APPLY TWO COATS POLYURETHANE VARNISH. SANDPAPER LIGHTLY BETWEEN COATS EXTERNAL: PREPARE AND CLEAN. APPLY TWO COATS P.P.R. WOODSHIELD.	
FANLIGHT	NONE.	
IRONMONGERY AND SUNDRIES	SEE SPECIFICATION.	

DOOR NO.	D9	NUMBER REQD.
FRAME DESCRIPTION	MUTUAL DS1 6mm RECORDROOM DOOR. +/-230kg COMPLETE WITH 7 BOLTS OF 32mm DIA. AND 7 LEVER SECURITY KEYLOCK. INSTALLED STRICTLY ACCORDING TO MANUFACTURER'S SPECIFICATION. FINISH: FACTORY APPLIED PRIMER. PREPARE AND CLEAN. APPLY ONE COAT UNIVERSAL UNDERCOAT AND TWO COATS POLYURETHANE ENAMEL. SANDPAPER LIGHTLY BETWEEN COATS. COLOUR ACCORDING TO ARCHITECT.	
FRAME FINISHING	NO ACTION.	
DOOR DESCRIPTION	NEW 2032x1000x40mm THICK SOLID CORE DOOR WITH 3mm THICK TEMPERED HARDBOARD SIDES AND CONCEALED HARDWOOD EDGES. SUSPENDED FROM EXISTING SLIDING MECHANISM.	
DOOR FINISHING	PREPARE AND CLEAN. APPLY ONE COAT WOOD PRIMER AND TWO COATS POLYURETHANE VELVET ENAMEL. SANDPAPER LIGHTLY BETWEEN COATS. COLOUR ACCORDING TO ARCHITECT.	
FANLIGHT	NONE.	
IRONMONGERY AND SUNDRIES	SEE SPECIFICATION.	

DOOR NO.	D10	NUMBER REQD.
FRAME DESCRIPTION	NONE.	
FRAME FINISHING	NO ACTION.	
DOOR DESCRIPTION	NEW 2032x1000x40mm THICK SOLID CORE DOOR WITH 3mm THICK TEMPERED HARDBOARD SIDES AND CONCEALED HARDWOOD EDGES. SUSPENDED FROM EXISTING SLIDING MECHANISM.	
DOOR FINISHING	PREPARE AND CLEAN. APPLY ONE COAT WOOD PRIMER AND TWO COATS POLYURETHANE VELVET ENAMEL. SANDPAPER LIGHTLY BETWEEN COATS. COLOUR ACCORDING TO ARCHITECT.	
FANLIGHT	NONE.	
IRONMONGERY AND SUNDRIES	SEE SPECIFICATION.	

REVISION	DRAWN	DATE	REV. NO.
WYSIGING	GETEKEN	DATUM	WYS. NR.
PROJECT			
STANDARD TRIBAL OFFICE for THE DEPARTMENT of TRADITIONAL AFFAIRS			
DRAWING			
DOOR SCHEDULE			
SCALE	1:30	DRAWN	D.C.
SKAAL		GETEKEN	
DATE	2018/01/17	CHECKED	D.C.
CLIENT NO.	CLIENT NR.		
PROJECT NO.	STAGE	DRAWING NO.	REVISION
LDPWRI	3	TO 1.7	
PROJEX NR.	PROJAB	TEKSENING NR.	WYSIGING

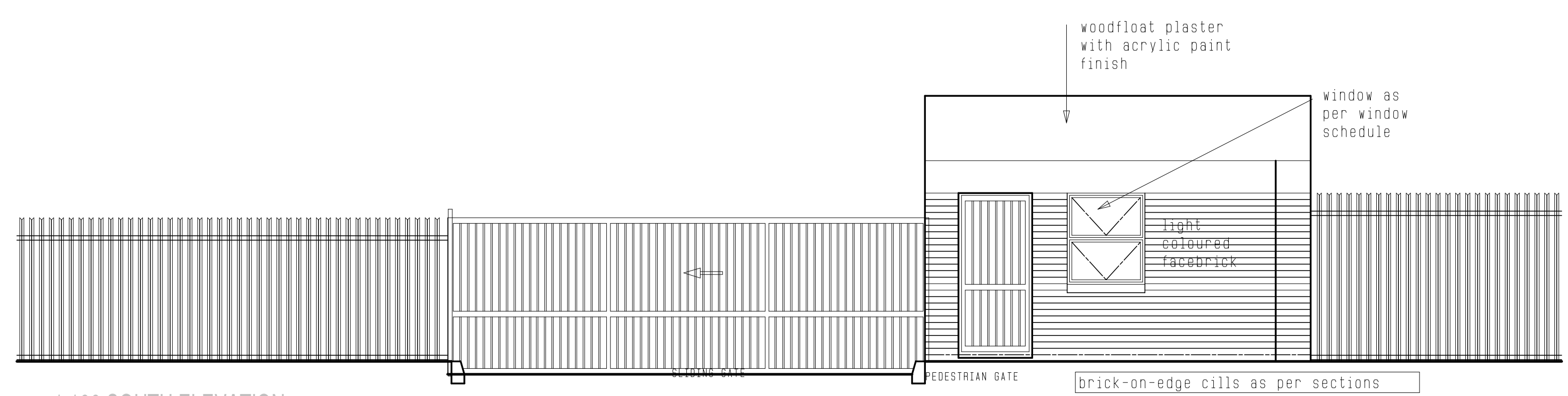

1:100 SOUTH ELEVATION

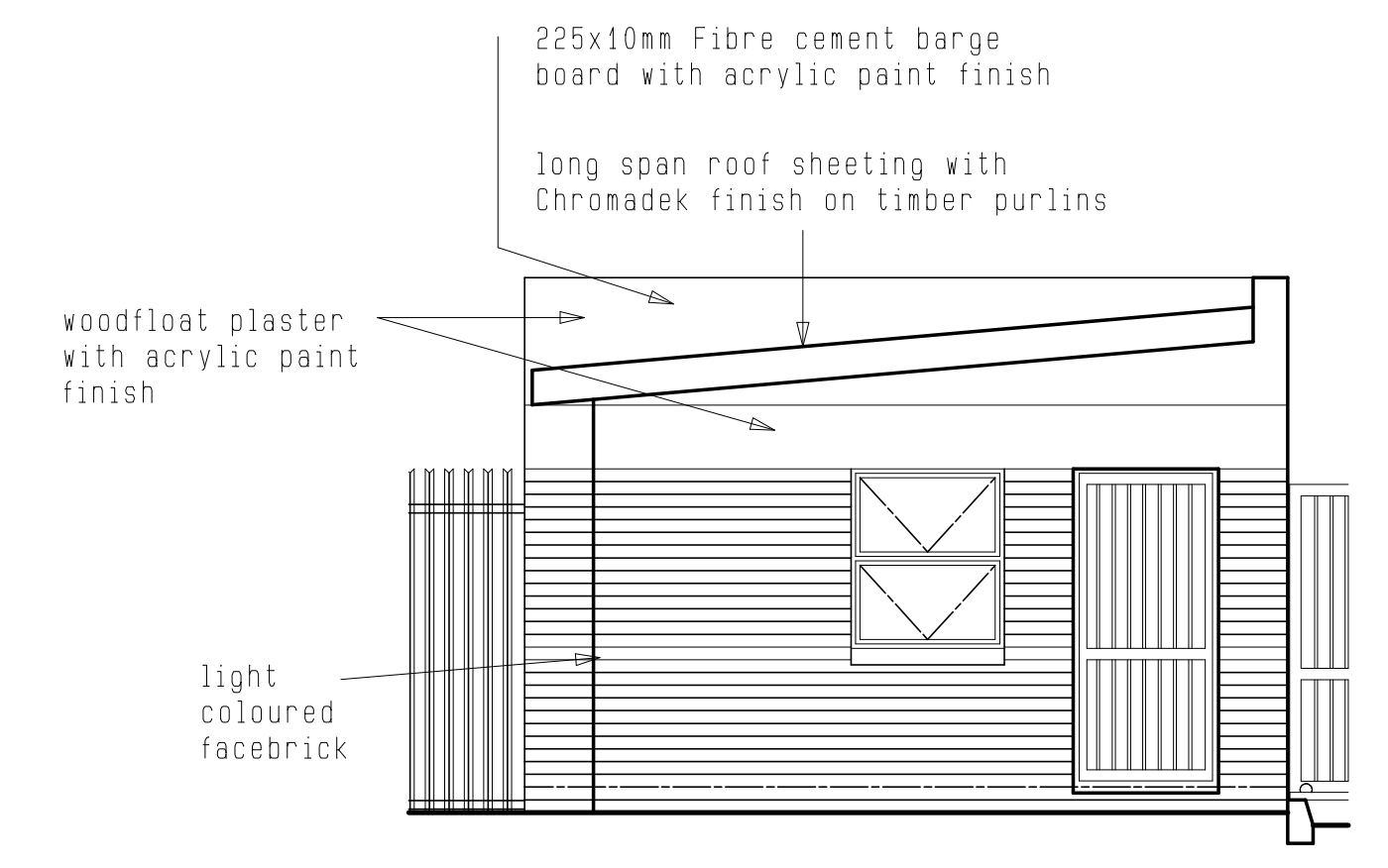

NORTH ELEVATION

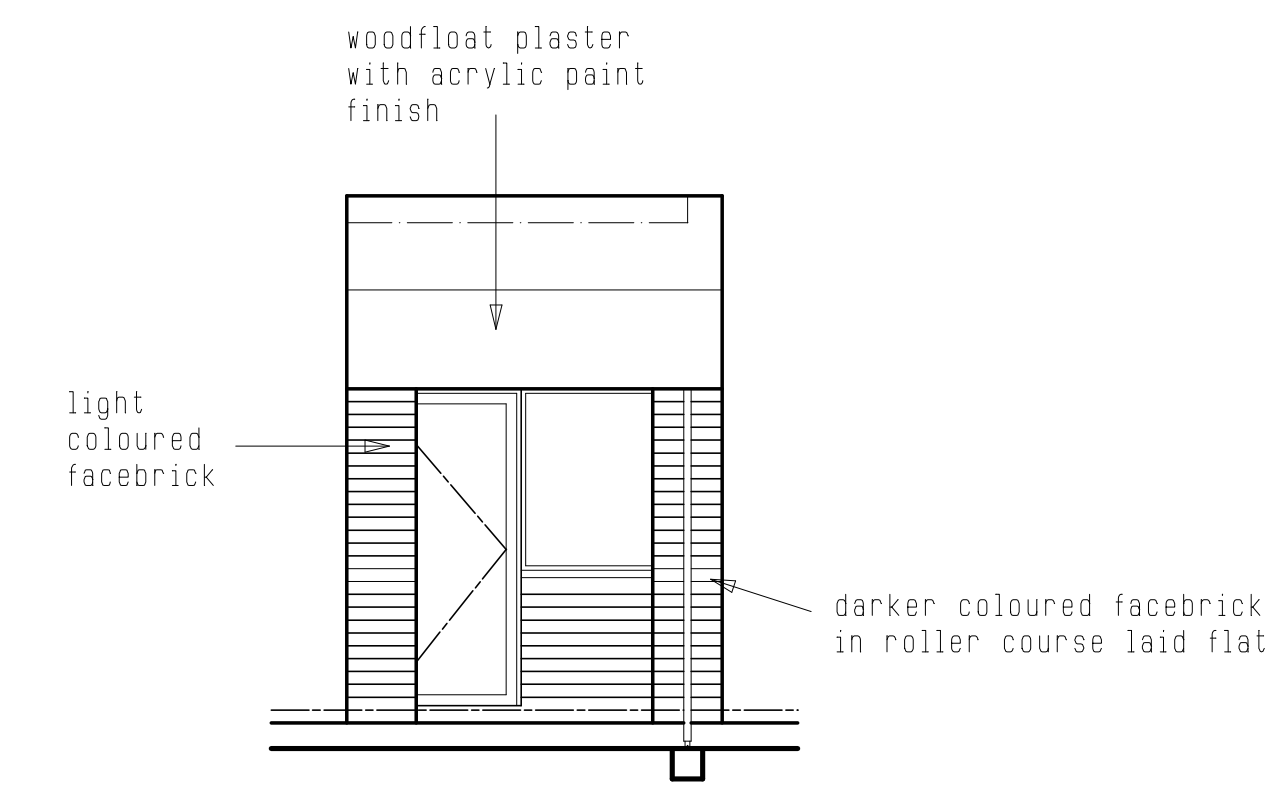

EAST ELEVATION

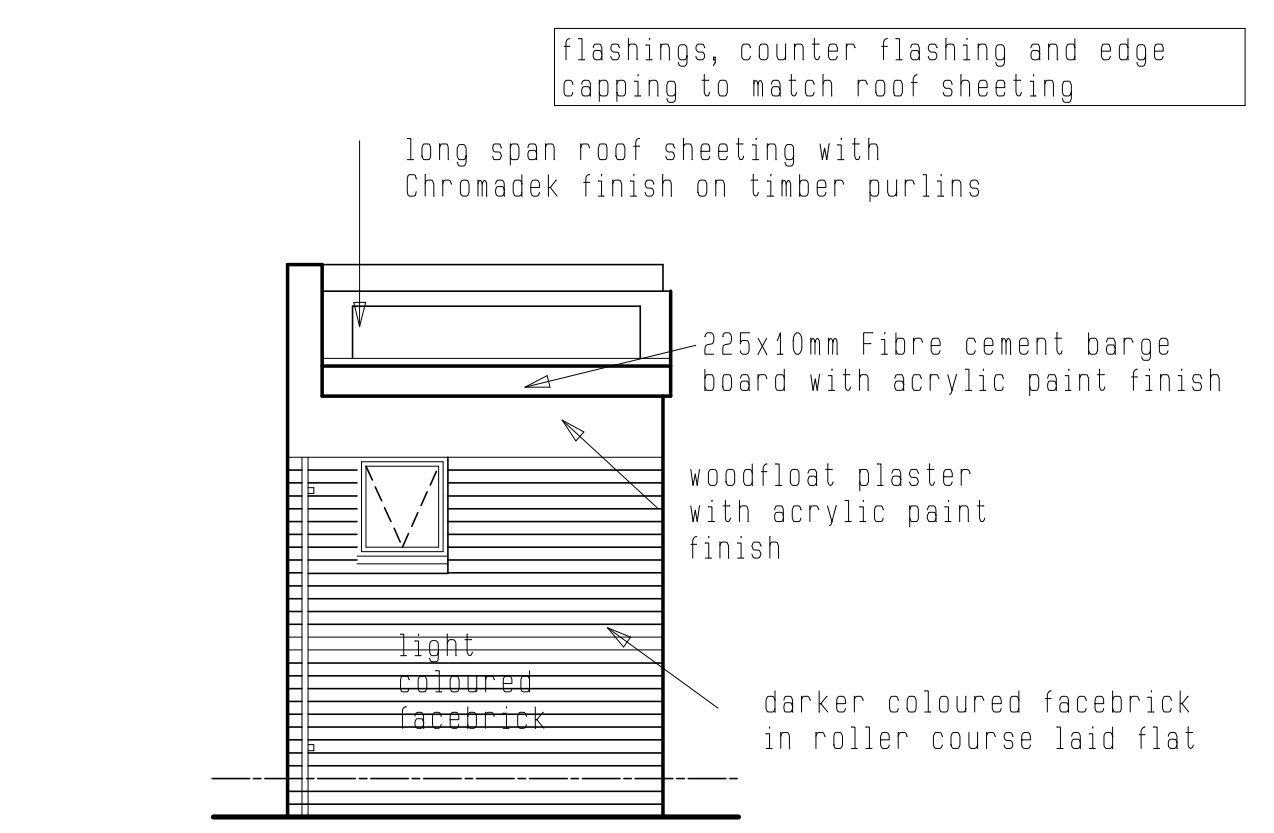

1:100 WEST ELEVATION

Brickwork in 1:5 cement mortar with joints raked out to receive plaster. Brickforce every 5th course and every 3rd course above lintol height.

Facebrick in stretcher bond in 1:5 cement mortar with square raked out joints. Horizontal band in darker brick

Steel window as per window schedule with brick-on-edge cill. 250 micron DPC built in two layers below cill, taken up between skins and tucked in below frame.

Prefabricated timber trusses at 1200mm centres tied to wall with 32x2mm galv. hoop iron anchors cast into concrete beams And wrapped around trusses and nailed. All exposed ends of trusses to be treated with carbolinium.

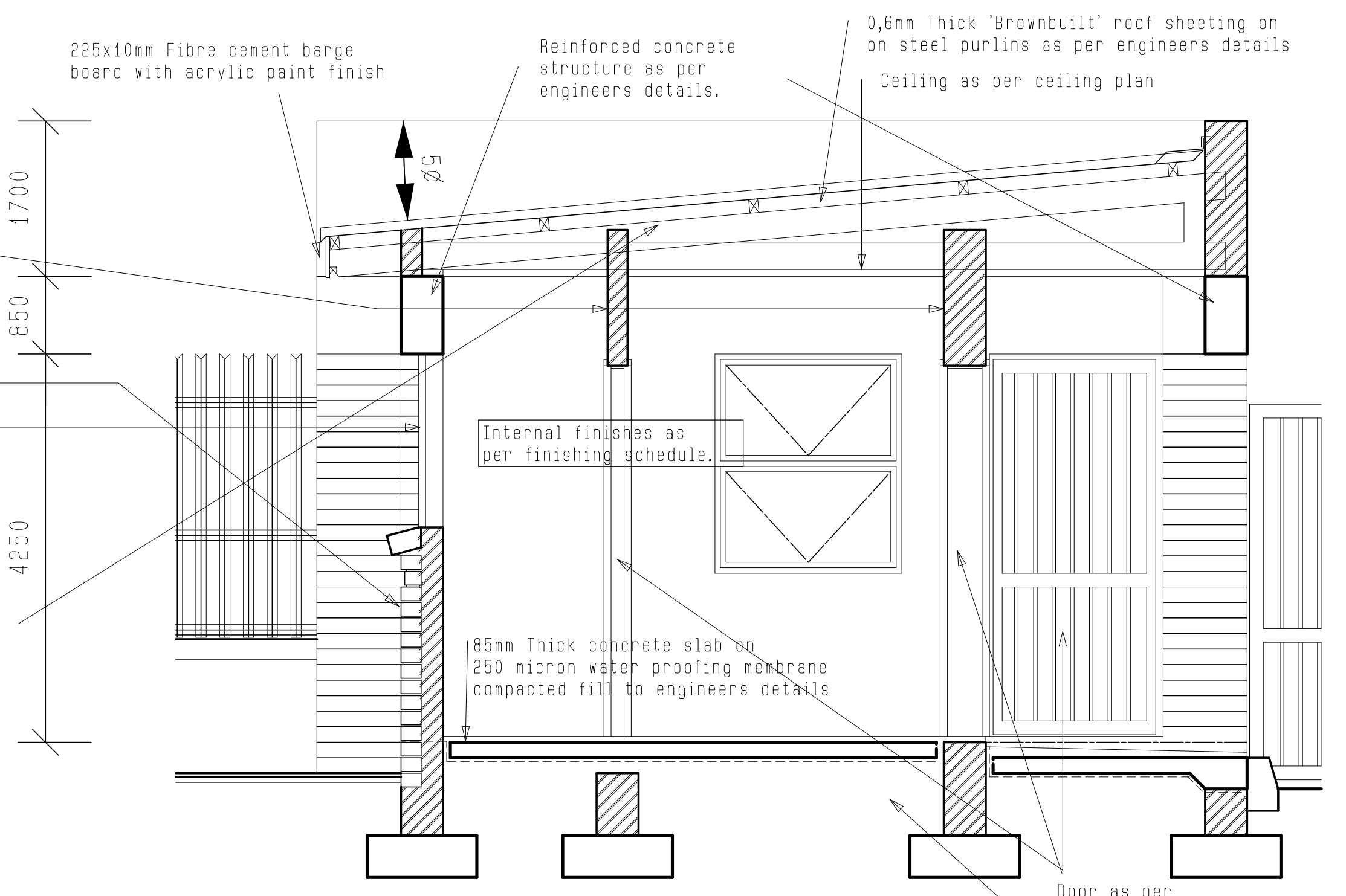

1:50 SECTION A-A

Concrete foundations per Engineers drawings  
Earth fill compacted to Engineers specification

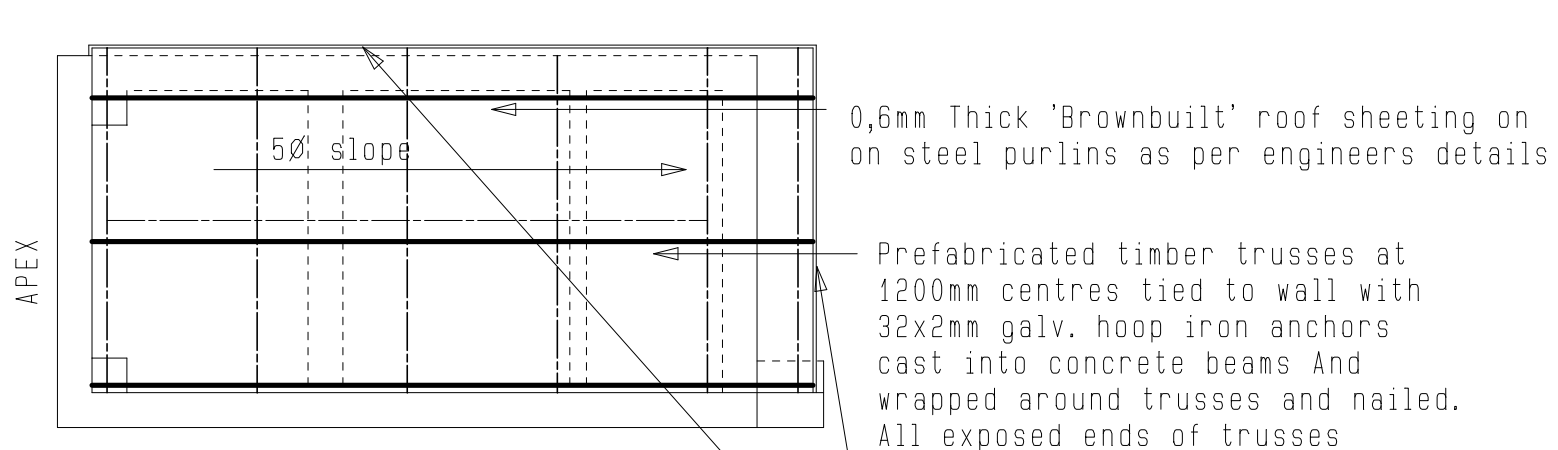

1:100 ROOF PLAN

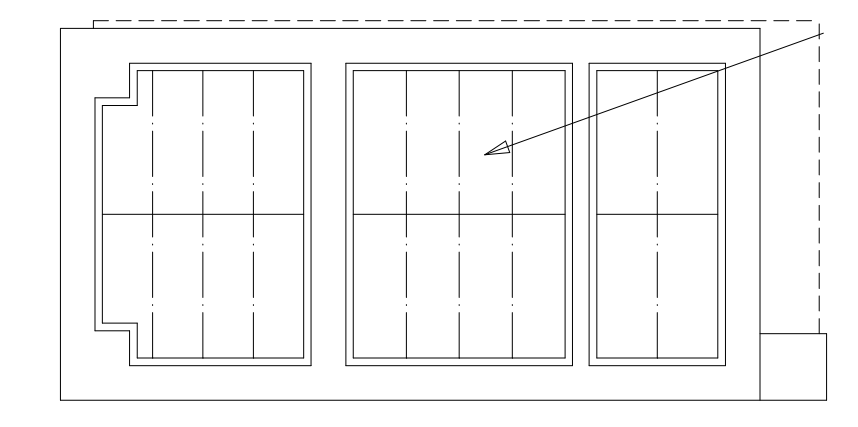
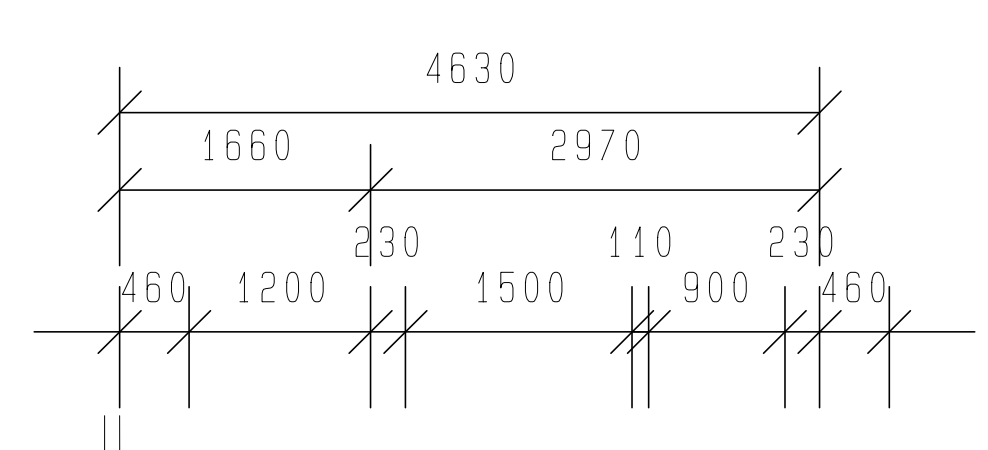

1:100 CEILING PLAN

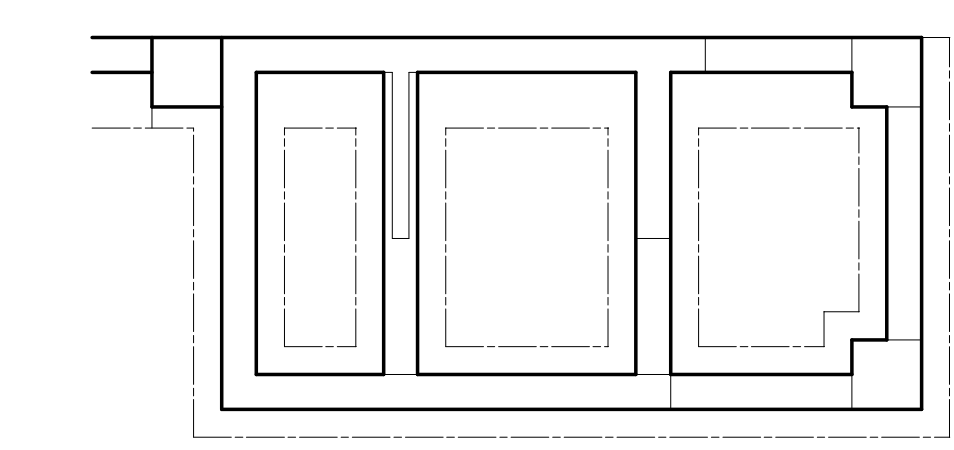

1:100 FOUNDATION PLAN

1:100 GUARDHOUSE AND FENCE: PLAN

REVISION	DRAWN	DATE	REV NO.
WYSIGING	GETEKEN	DATUM	WYS NR.
PROJECT		PROJEK	
<b>PROPOSED NEW LIBRARY NZHELELE THE DEPARTMENT OF ARTS, SPORT AND CULTURE</b>			
DRAWING		TEKENING	
<b>GUARD HOUSE</b>			
SCALE	1:100 1:50	DRAWN	D.C.
SKAAL		GETEKEN	
DATE	2013/09/17	CHECKED	D.C.
CLIENT NO.		KLIJENT NR.	
<b>LIMPOPO DEPT. OF WORKS</b>			
PROJECT NO.	STAGE	DRAWING NO.	REVISION
1	3	1.6	-
PROJ. NR.	PROB. NR.	TEKENING NR.	WYSIGING